



HAL
open science

Tool wear during wood sawing: influence of certain physical and chemical properties for 285 wood species

Jean Gérard, Rémi Curti, Bernard Thibaut

► **To cite this version:**

Jean Gérard, Rémi Curti, Bernard Thibaut. Tool wear during wood sawing: influence of certain physical and chemical properties for 285 wood species. Bois et Forêts des Tropiques, 2025, 362, pp.1 - 15. <10.19182/bft2025.362.a37858>. <hal-05489267>

HAL Id: hal-05489267

<https://ut3-toulouseinp.hal.science/hal-05489267v1>

Submitted on 2 Feb 2026

HAL is a multi-disciplinary open access archive for the deposit and dissemination of scientific research documents, whether they are published or not. The documents may come from teaching and research institutions in France or abroad, or from public or private research centers.

L'archive ouverte pluridisciplinaire HAL, est destinée au dépôt et à la diffusion de documents scientifiques de niveau recherche, publiés ou non, émanant des établissements d'enseignement et de recherche français ou étrangers, des laboratoires publics ou privés.



Distributed under a Creative Commons CC BY 4.0 - Attribution - International License

Tool wear during wood sawing: influence of certain physical and chemical properties for 285 wood species

Jean GÉRARD^{1,2}
Rémi CURTI³
Bernard THIBAUT^{4,5}

¹ CIRAD UPR BioWooEB
34398 Montpellier
France

² BioWooEB Univ Montpellier
CIRAD
Montpellier
France

³ Institut Clément Ader (ICA),
Université de Toulouse, CNRS
UMR 5312, INSA,
ISAE-Supaéro, INSA,
IMT Mines Albi
1 rue Lautréamont
65016 Tarbes
France

⁴ LMGC, Univ. Montpellier,
CNRS, Montpellier
France

⁵ Université de Montpellier
CC 048 - 163 rue Auguste
Broussonnet
34090 Montpellier
France

**Auteur correspondant /
Corresponding author:**
Jean GÉRARD –
jean.gerard@cirad.fr

 **ORCID** : <https://orcid.org/0000-0002-5005-8636>



Photos 1.

A. Tropical Garden in Nogent sur Marne, Indochina building where André Chardin developed the CTFT Laboratory. The photo is produced by Clarisse Didelon-Loiseau, and was extracted from her article « Le jardin tropical de Paris », published in the journal Mappemonde, 2017, no 120. B. André Chardin (1920–1987), photo extracted from the journal Bois et Forêts des Tropiques.

Doi : 10.19182/bft2025.362.a37858 – Droit d’auteur 2025, Bois et Forêts des Tropiques – Cirad – Date de soumission : 5 mai 2025 ; date d’acceptation : 24 septembre 2025 ; date de publication : 1^{er} octobre 2025.



Licence Creative Commons :
Attribution - 4.0 International.
Attribution-4.0 International (CC BY 4.0)

Citer l'article / To cite the article

Gérard J., Curti R., Thibaut B., 2025. Tool wear during wood sawing: influence of certain physical and chemical properties for 285 wood species. Bois et Forêts des Tropiques, 362 : 1-15. Doi : <https://doi.org/10.19182/bft2025.362.a37858>

RÉSUMÉ

Usure des outils lors du sciage du bois : influence de certaines propriétés physiques et chimiques pour 285 essences de bois

L'usure des outils de coupe constitue un enjeu majeur pour l'industrie forestière et fait l'objet de nombreuses recherches visant à comprendre et limiter leur dégradation. Parmi les facteurs influençant cette usure, les propriétés des bois, très variables selon les espèces, jouent un rôle déterminant.

Il y a 60 ans, André Chardin (décédé en 1987) a mené une étude expérimentale de 15 ans sur l'usure des outils lors du sciage de bois tropicaux. Sur 4 000 essais de coupe, 835 essais standard ont été réalisés avec une épaisseur de copeaux uniforme sur 554 arbres représentant 285 espèces, 200 genres et 59 familles, à différents taux d'humidité (bois vert et bois sec). L'usure des outils variait considérablement, en partie à cause de la flexion plastique du tranchant sous une contrainte mécanique élevée. La relation entre le recul de la pointe de l'outil et la longueur de coupe suivait une loi de puissance avec un exposant médian d'environ 0,7, qui était plus faible pour les essais montrant une flexion de la pointe et pour le bois sec par rapport au bois vert.

En classant les essais selon la teneur en humidité (sec ou vert) et en silice (siliceux ou non siliceux), Chardin a pu étudier l'influence de ces paramètres sur le recul d'arête. La flexion de la pointe de l'outil a été observée dans 42 % des cas pour les bois secs non siliceux, 10 % pour les bois secs siliceux ou les bois verts non siliceux, et seulement 3 % pour les bois verts siliceux. Le brûlage de la face de l'outil est également fréquent (42 %) pour les bois secs non siliceux.

Pour les 78 % d'essais sans flexion de la pointe, une régression linéaire progressive sur les valeurs logarithmiques des paramètres d'usure et du bois a permis d'obtenir un taux de prédiction de 58 %. La teneur en silice est le facteur principal (42 %), suivie de la teneur en humidité (8 %), de la densité (7 %) et, dans une moindre mesure, de la teneur en matières extractives organiques (0,4 %).

Cette influence très faible des extractibles contraste avec leur rôle connu dans la corrosion et la friction acier/bois, probablement en raison d'effets opposés selon la nature chimique des substances et les espèces concernées.

Mots-clés : usure des outils de coupe, opérations de sciage du bois, bois feuillus tropicaux, teneur en silice du bois, teneur en humidité du bois.

ABSTRACT

Tool wear during wood sawing: influence of certain physical and chemical properties for 285 wood species

Tool wear is a major issue in the forest industry, and extensive research has been carried out to understand its causes and to limit tool degradation. Among these causes, the properties of the machined wood — highly variable between species — play a crucial role.

Sixty years ago, André Chardin (d. 1987) conducted a 15-year experimental study on tool wear during the sawing of tropical woods. Out of 4,000 cutting tests, 835 standard tests with uniform chip thickness were performed on 554 trees representing 285 species, 200 genera and 59 families, at both green and air-dry moisture contents. The tested woods were highly diverse, reflecting the wide variability typical of tropical species.

Tool wear varied greatly, partly due to plastic bending of the cutting edge under high mechanical stress. The relationship between tool tip recession and cutting length followed a power law with a median exponent of about 0.7, which was lower for tests showing tip bending and for dry wood compared with green wood.

Silica content emerged as the dominant factor influencing wear, given its large variation among species, while extractive content was not significant. Wood density and moisture content also affected wear, though to a much lesser extent. Grouping the tests by moisture (dry versus green) and silica content (siliceous versus non-siliceous) highlighted the combined effects of density and moisture on edge recession. Tool tip bending occurred frequently (42%) for dry non-siliceous woods, less often (10%) for dry siliceous or green non-siliceous woods, and rarely (3%) for green siliceous woods. Tool face burning was also common (42%) in dry non-siliceous woods.

For the 78% of tests without tool tip bending, progressive linear regression on logarithmic wear and wood parameters yielded a 58% predictive value: silica (42%), moisture (8%), specific gravity (7%), and extractives (0.4%). The minimal impact of extractives contrasts with their known influence on steel corrosion and friction, likely due to opposing effects of different extractive compounds across species.

Keywords: cutting tool wear, wood sawing operations, tropical hardwoods, silica content in wood, wood moisture content.

RESUMEN

Desgaste de la herramienta durante el aserrado de madera: influencia de determinadas propiedades físicas y químicas en 285 especies de madera

El desgaste de las herramientas es un problema clave en la industria forestal, y numerosos estudios han tratado de comprender sus causas y soluciones. La variabilidad de la madera según la especie influye directamente en este desgaste.

Hace sesenta años, André Chardin (fallecido en 1987) investigó durante quince años el desgaste de herramientas al cortar madera tropical. Realizó 835 pruebas estándar con viruta uniforme en 554 árboles de 285 especies, 200 géneros y 59 familias, tanto en madera verde como secada al aire, abarcando la gran diversidad típica de estas especies.

El desgaste dependió de la tensión mecánica. La relación entre la punta de la herramienta y la longitud de corte siguió una ley de potencia con exponente medio de 0,7, menor en maderas secas o cuando la punta se flexionaba. El contenido de sílice tuvo gran influencia, mientras que los extractivos afectaron mínimamente. La densidad y la humedad también influyeron, aunque en menor medida. La punta se dobló principalmente (42 %) en maderas secas no síliceas, en menor medida (10 %) en maderas síliceas o verdes no síliceas, y casi nunca (3 %) en verdes síliceas. La quemadura en la cara de la herramienta fue frecuente (42 %) en maderas secas no síliceas.

En el 78 % de las pruebas sin flexión de la punta, la regresión lineal sobre el desgaste logarítmico y los parámetros de la madera predijo un 58 % del desgaste: sílice (42 %), humedad (8 %), gravedad específica (7 %) y extractos (0,4 %). Aunque su impacto es mínimo, los extractos influyen en la corrosión y fricción del acero debido a efectos opuestos según la especie.

Palabras clave: desgaste de la herramienta de corte, operaciones de aserrado de madera, maderas duras tropicales, contenido de sílice en la madera, contenido de humedad de la madera.

Introduction

Wear results from tool/wood interactions during the cutting process. It occurs on the rake and clearance faces, taking three primary forms (Klamecki 1979): impact wear (early tool tip degradation under impact forces), corrosive wear (crack occurrence at the tool tip promoted by stress corrosion mechanisms), and abrasive wear (changes in tool tip geometry induced by progressive grinding). The many parameters involved in the wear or degradation of a wood-cutting tool can be grouped into two main categories: those related to the nature of the tool or machine settings, and those directly related to the nature of the wood being machined (Klamecki 1979).

The literature on tool parameters (nature of the material, surface treatment or coating, cutting angles, sharpening techniques, etc.) is abundant, both before and since Klamecki's review (Mohan & Klamecki 1981; Porankiewicz et al. 2005; Porankiewicz et al. 2006; Okai et al. 2006; Nouveau et al. 2009; Darmawan et al. 2011; Fahrussiam et al. 2016; Porankiewicz et al. 2016; Muhammed et al. 2023). The nature of the wood is often taken into account in these studies, which typically use a few temperate or tropical wood species (always fewer than 10), or even palm wood, fibreboard, or particleboard. The density, the presence of organic compounds (glues and extractives), or mineral contamination (ash and/or silica) are often analysed under the test conditions.

For solid wood, the primary source of variation in properties and mechanical behaviour is the genetic diversity of the trees from which the wood samples are taken. Each species has a physical signature – the anatomy of its cellular material – and a chemical signature: a cocktail of organic extractives and elements that are the source of “mineral contamination” present in ash (Gérard et al. 2019). Variations in physical and chemical parameters, linked to the adaptation of wood growth to the tree's living conditions, also need to be considered (Almérás et al. 2025). Lastly, wood is a hygroscopic material, and its humidity can vary over a vast range (Glass & Zelinka 2010).

If the influence of the type of wood being machined is to be properly analysed, it is necessary to set all the tool and process parameters for a large number of tests on different woods. André Chardin did this in the 1960s. The data from that experimental work was used to test the following hypothesis: “Wear increases when density increases, when humidity decreases and when the level of organic and mineral extracts (particularly silica) increases.”

History and scope

The French Tropical Forestry Centre (CTFT) was set up in 1949 (Catinot 1994) with five wood research divisions: anatomy, chemistry, cellulose, wood protection and improvement, and technology. The technology division had two major programmes: i) determination of the physical and mechanical properties of tropical woods and ii) studies on the machining of those woods. In 1970, the eight tropi-

cal agronomic research organisations in France (including CTFT) were merged into an economic interest grouping (GIE) called GERDAT. In 1984, GERDAT was unified and transformed into the public research organisation CIRAD. CTFT ceased as an independent structure and became CIRAD's forestry department.

Over the course of more than 30 years, up to 1984, based on long-term protocols, wood science laboratories produced extensive paper databases encompassing several thousand tests on nearly a thousand species across various disciplines. Most of these paper documents were preserved. A small proportion of the results (generally averages for one tree) were digitised in the 1980s and revised in the mid-1990s (Gérard & Narboni 1996), but were not made available to the scientific community at that time. Jean Gérard (Wood Properties Laboratory from 1988 to date) and Bernard Thibaut (Wood Mechanics and Wood Machining Laboratory from 1975 to 1978) jointly decided to make a significant share of these digitised results available to the international scientific community, through publications in the journal *Bois et forêts des tropiques*, CTFT's (now CIRAD) historical journal from its inception (Langbour et al. 2019; Gérard et al. 2019; Candelier et al. 2023). Today, computer tools that were not available during the CTFT period make it possible to perform specific data analyses while also describing the data and the experimental protocol.

Research on cutting tool wear

André Chardin (1920-1987) had his first job in a sawmill in Vietnam just after World War II. He was struck by the diversity of machining results for local tropical species, particularly in terms of bandsaw tooth wear. He was the founder of the Wood Mechanics and Machining Laboratory and its director throughout the CTFT's life (1949-1984). In the early 1950s (Chardin 1954), he initiated a study of cutting forces on a saw tooth using an instrumented Charpy pendulum (Chardin 1958). In 1963, he was one of the founders of the International Wood Machining Seminar (IWMS), whose 26th session was held in Florence in 2025. He was the reference for wood machining in France (Thibaut et al. 2016).

In 1958 he decided to devote “most of the resources of CTFT's machining laboratory to the study of sawtooth wear” (Chardin 1966), employing seven technical staff to design and build the experimental devices, prepare and sharpen the tools, photograph the cutting edges and their resin casts, draw the cutting profiles in enlargement, and carry out several thousand tests amounting to several thousand km of cutting over around ten years.

An extensive collection of tools, photographs, captioned drawings, and handwritten test files, gathered at the end of the tests, was transferred to Montpellier in 1994. Anne Thibaut (1945-2012) and Jean Gérard digitised the tool recession measurements from more than four thousand test files in a reference Excel file.

In an initial series of three articles published in the journal *Bois et forêts des tropiques* (Chardin 1966; Chardin 1967a; Chardin 1967b), André Chardin went into great detail on “The need for a study of wear and the choice of working method”, based on the state of the art in science and practice.

A second series of three articles, which are available online in French, also appeared in *Bois et forêts des tropiques* (Chardin & Froidure 1967; Chardin & Froidure 1968a; Chardin & Froidure 1968b), in which the authors described at length (50 pages), with many illustrations (40 figures and 29 tool tip pictures), how the adopted method was implemented and how the results were published.

A book in two volumes, totalling 660 pages, published by CTFT (Chardin & Froidure, 1969; Chardin & Froidure, 1970), is the only publication presenting the results of that study, which includes both tool recession graphs and drawings of tool tip profiles at different cutting lengths. They cover a total of 800 tests on 88 species, all using the same tooth steel. Volume 1 is dedicated to the influence of chip thickness (0.15 mm or 0.5 mm), while Volume 2 is dedicated to the influence of cutting speed (22 m/s and 45 m/s).

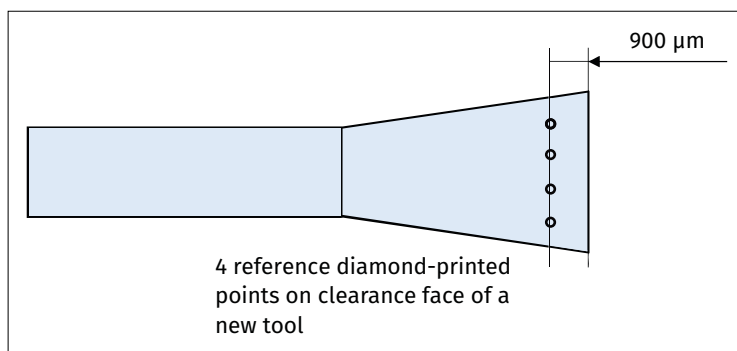

Figure 1.
Reference points on tool clearance face (from Chardin & Froidure 1968a).

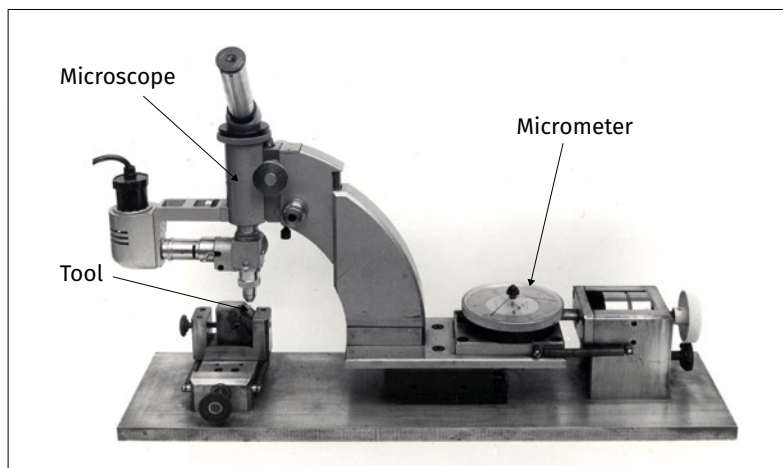

Figure 2.
Photo of the microscope used to mark the tool with a diamond and then measure tool tip recession.
Photo A. Chardin.

Scope of the article

The aim of this article is to:

- i) make these results available to the scientific community, to enable possible meta-analyses of how tree species affect tool wear.
- ii) better understand how physical factors influence tool wear rates.

There has never been such a wide-ranging collection of data, representative of the diversity of wood species, in the study of cutting tool wear in a standard test.

Material and Method

Experimental protocol

A detailed overall protocol for all the operations was described in three successive articles (Chardin & Froidure 1967; Chardin & Froidure 1968a; Chardin & Froidure 1968b) and should be considered as a detailed “Method” section for all the experimental work. A summary in English is provided below for the reader’s convenience. All figures are taken from the three articles, with the legends also translated.

Removable, mass-produced steel saw teeth were used in all tests on a circular saw (61 cm diameter) equipped with only one tooth for each test. Most of the teeth were manufactured from low-alloy steel (of good Swedish type quality, labelled A), sometimes reinforced by stellite (Tungsweld) tipping, with some also being manufactured from high-speed steel (Simmonds USA), which is harder. All the teeth were prepared in the same reproducible way, including very accurate sharpening at defined tool angles.

The wood samples came from botanically identified trees (with a CTFT identifier). The moisture content of each sample (for each test) was measured, and the mean wood properties associated with the exact tree origin (specific gravity, silica content, and alcohol-benzene extract) were documented by the other CTFT laboratories. The height of the wood sample (i.e., cutting length for each saw rotation) was also measured for each test.

Each test was defined by its cutting conditions: rake angle, tool angle, clearance angle, cutting speed and chip thickness. Successive cutting stops at growing saw feed provided tool-wear measurements. The cutting length (L_i in m) at each measuring step could be calculated using the number of elementary cutting paths. Tool wear was documented by two methods: tool tip recession and the tool wear profile at the different successive cutting lengths.

In order to measure the tool tip recession, four aligned reference points were engraved on the clearance face with the point of a diamond at a distance of 900 μm from the virgin tool tip (figure 1). After each cutting stop, the distances between those reference points and the corresponding positions of the blunted edge were measured (figure 2). The mean difference between 900 μm and the mean value of these 4 “blunted” distances is called tool tip recession (R_i in μm).

The tool wear profile is a fuller quasi-3D description of the tool tip at each cutting stop using two techniques: i) macrophotography of the tool tip on the rake face and clearance face showing the whole edge in length and ii) precise moulding of the cutting part of the tool in order to obtain a transverse image of the tool tip, called the tool wear profile.

Photographs of the tooth rake and clearance faces, taken before and after cutting, were captured on 9 × 12 cm film at a magnification of approximately ×13 and then printed on paper to a scale of exactly ×50. It was easy to see from these prints whether the wear was regular (figure 3) or not (figure 4). The photographs also provided a wealth of additional information on both edge and tooth lateral tip wear. This qualitative information is not used in this publication.

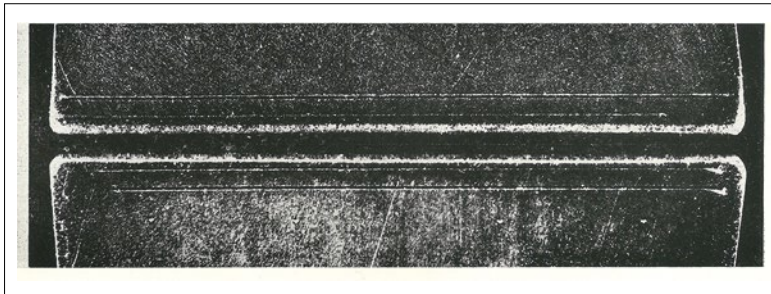

Figure 3.
A perfectly regular blunt edge.

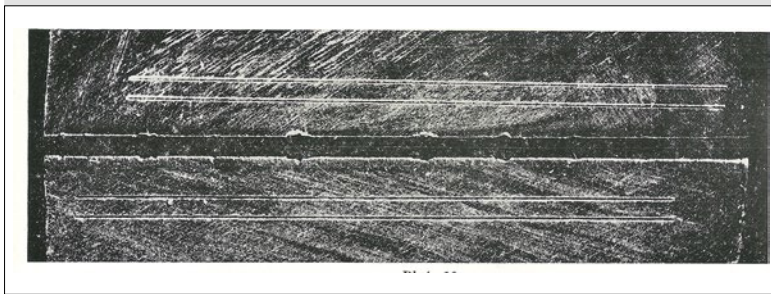

Figure 4.
A blunt edge with 5 notches (Chardin & Froidure, 1968b).

The moulding of the tool, coated with a thin film (0.3-0.4 μm thick) of beeswax, was made using bi-component white Araldite (CIBA Araldite M). Once the tooth had been removed (demoulded), the volume it occupied in the mould was filled with a black resin that highlighted the surface separating the two resins. This was the external surface of the blunted tool. The cast coated in this way was sectioned and polished at a constant position from the edge of the tooth. This gave a perfect, contrasting image of a cross-section of the worn tooth. Significant signs of tooth heating (blue-black or brown discolouration) were observed on the front and back surfaces of the tool at the end of the test.

Profiles were photographed using a metallographic microscope (Reichert) on 9 × 12 cm film at approximately ×200 magnification. The photograph of an objective micrometre, taken under the same conditions, was used to adjust the enlarger to obtain a final magnification on paper of ×500. The resulting wear profile was reproduced identically on A3 tracing paper, using Indian ink. Information on 18 parameters relating to the test was written on the same tracing, which could then be reproduced for publication (figure 5).

Observations of all the tool wear profiles were used to provide a reference Excel file with the following information: tool material, occurrence of tool tip bending (figure 6), and occurrence of burning on tool faces.

Wood species

Each test was referenced by both the test number (1 to 4175) and the CTFT tree identifier (61 to 21339). Using this CTFT tree identifier, it is possible to obtain different information on the wood tested via an anatomy and chemistry database (Langbour et al. 2019; Gérard et al. 2019). This includes the country where the tree was harvested; its botanical family, genus, and species; the alcohol-benzene extractive content (%) of the tree or the species mean; the specific gravity of the tree or the species mean; and the silica content (ppm) of the tree or the species mean. The moisture content of the cut specimen is a parameter in the reference Excel file.

Statistical analyses

Basic statistical analyses were performed using XLSTAT software. The normality of the distribution was verified by a Shapiro-Wilk test. A Pearson correlation analysis was used when the data followed a normal distribution, while a Spearman correlation analysis was employed when the data did not follow a normal distribution, which was the case in the majority of instances. The settings for the linear regression were as follows: stepwise linear regression, with the following parameters: confidence interval (%): 95, tolerance: 0.0001, probability of entry: 0.05 / probability of withdrawal: 0.1.

Standard tests

A selection of 835 standard trials, all using the same low-alloy steel and the same cutting settings (rake, tool and clearance angles, cutting speed and chip thickness), involving 554 trees from 285 species in 200 genera and 59 families, was used in an attempt to analyse how the rate of tool wear is influenced by physical (wood density and moisture content) and chemical (alcohol-benzene extractives and silica content) parameters, describing different wood species.

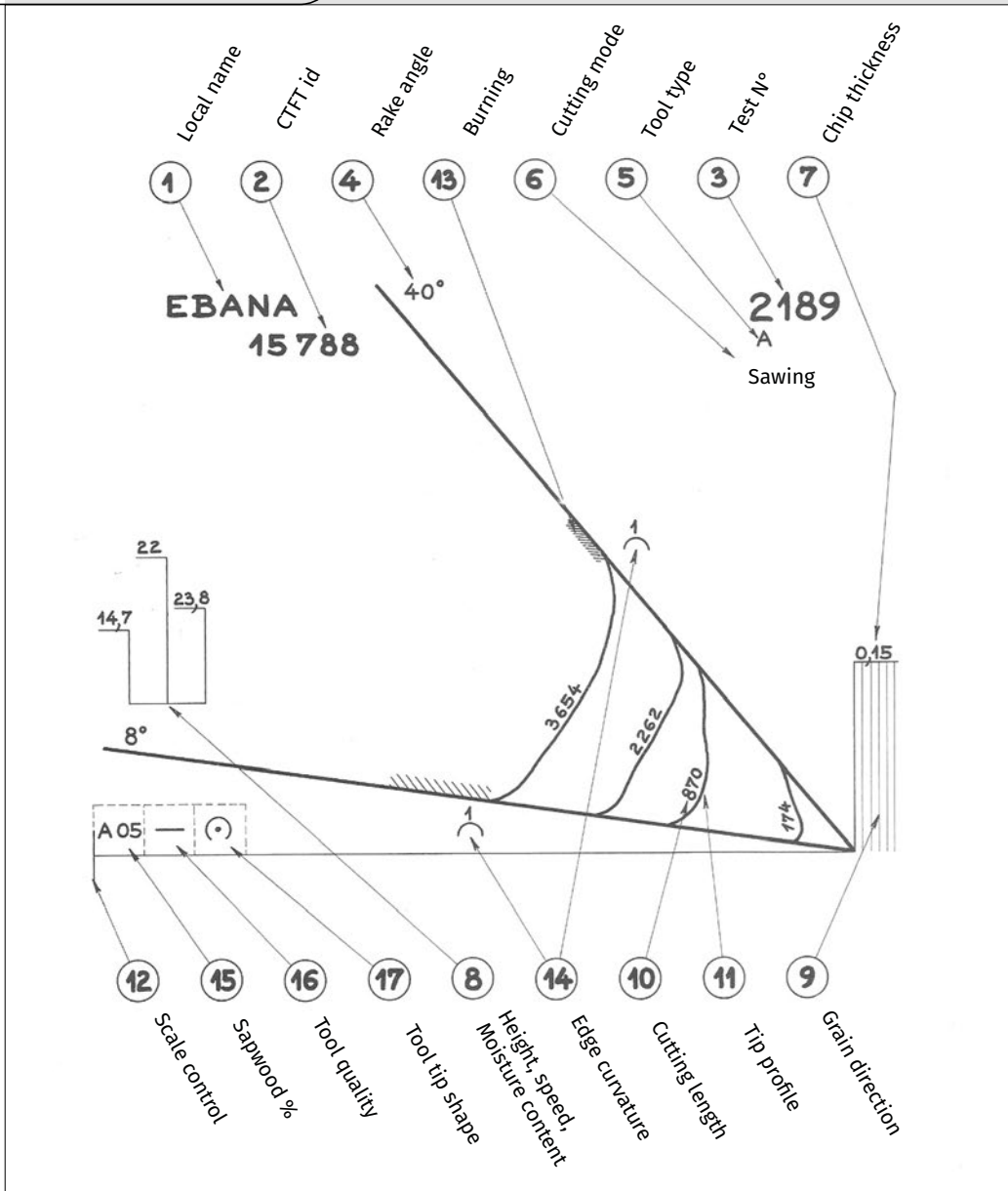

Figure 5. Example of a successive tool wear profile description with legends, page III (Chardin & Froidure 1969).

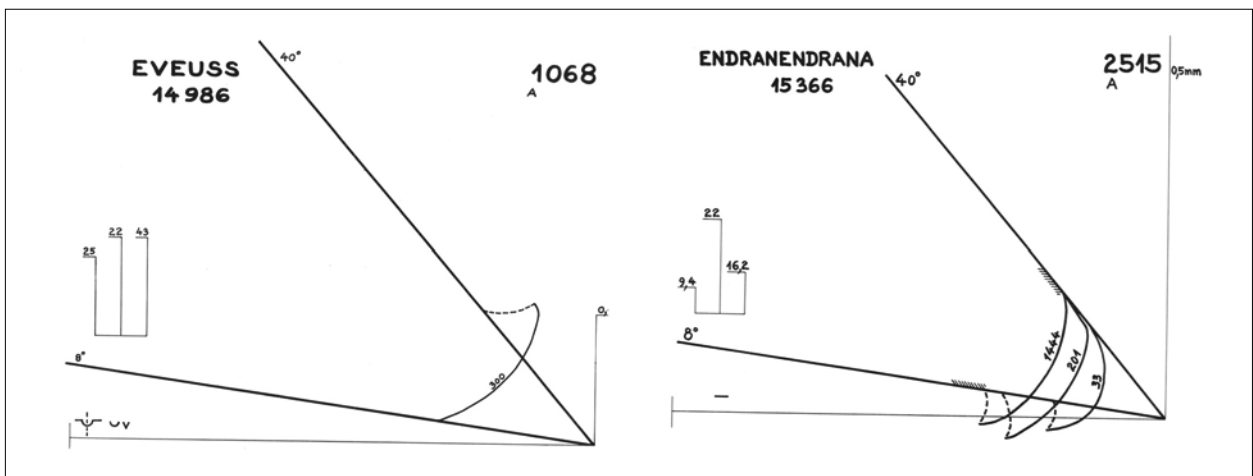

Figure 6. Examples of upward tool tip bending (1068) and downward tip bending (2515) (Chardin & Froidure 1969).

Results

Description of the tool recession file

In total, 835 standard tests, which contain all the information on wood and tool wear, are represented in the Excel file (see Dataverse file).

Fifty-eight columns provide information and data for each cutting test as follows: the country where the tree was harvested; botanical family, genus, and species; CTFT identifier; test identifier; tool type; typology code related to both silica (Si) and moisture content (MC) of the cut sample; tool tip bending occurrence (Ret); tool face burning occurrence (Bur); alcohol-benzene extractive content (AB, %); silica content (Si, ppm); specific gravity (SG); moisture content (MC, %); rake angle (Ra, °); clearance angle (Ca, °); cutting speed (Cs, m/s); chip thickness (CT, 10^{-5} m); ratio between edge tool tip recession R (μm) and length of cut L (m) at first observation ($R1/L1$, $\mu\text{m}/\text{m}$); ratio between edge tool tip recession R (μm) and length of cut L (m) at last observation (Rm/Lm , $\mu\text{m}/\text{m}$); ratio between $R1/L1$ and Rm/Lm ($1/\text{m}$); tool tip recession and cutting length (Rm , m); maximum value of cutting length in the test (L_{max} , m); maximum value of tool tip recession in the test (R_{max} , μm); and the values of cutting length (L_i , m) and tool tip recession (R_i , μm) at the i^{th} observation, from 1 to n .

Six of the above parameters were kept constant throughout the 835 standard tests: the tool was always made of low-alloy carbon steel. It always had a cutting angle of 42° , a rake angle of 40° and a clearance angle of 8° (as well as a lateral clearance of 5 to 6°). The cutting speed was always 22 m/s and the chip thickness 0.15 mm. Moreover, as with all the tests, the cutting direction was always perpendicular to the grain.

Two possible options for a candidate descriptor of tool wear for a given step are to divide tool tip recession by cutting length at the first stop, $W1 = R1/L1$, or at the last stop (maximum cutting length), $Wm = Rm/Lm$.

From the succession of binomial information (L_i , R_i), it was possible to draw a growing curve describing the evolution of tool wear and adjust a trend line using Excel statistical software. A power law: $R = a \cdot L^b$ with only two parameters, constant term a and exponent b , proved to be the best simple law for nearly all tests, with a regression coefficient R^2 consistently above 0.6 (median value 0.96). A third and fourth candidate descriptor can be the value of the tool tip recession calculated by the power formula at a low cutting length (100 m): R_{cal} , and a high cutting length (1000 m): $R_{1\text{km}}$. As $R_{1\text{km}}$ cannot be calculated for tests with a low maximum cutting length (several hundred meters) and a small number of cutting stops (1, 2, and sometimes 3), 13% of all tests were excluded, namely those under the highest wearing conditions. R_{cal} was used for most of the following result descriptions.

The number of cutting stops for the test, parameters a and b together with the regression coefficient R^2 of the

power law and the wear descriptor R_{cal} , were added as columns in the Excel file of calculated data.

One test had a total of 17 cutting stops, and 55 had only one cutting stop; 5 cutting stops were the most frequent case (figure 7a). As a rule, a cutting test ended when the total cutting length was approximately $3,300$ m or the tool recession reached up to 230 μm (figures 7b and 7c).

Statistical analysis of all 835 tests

The specific gravity range for all tests was extensive, with the same coefficient of variation ($CV = 26\%$) as for the whole specimens in the CIRAD wood collection (Langbour et al. 2019). AB extractive content and moisture content had an extensive range and CV. Silica content and tool wear parameters exhibited significant variability (table I).

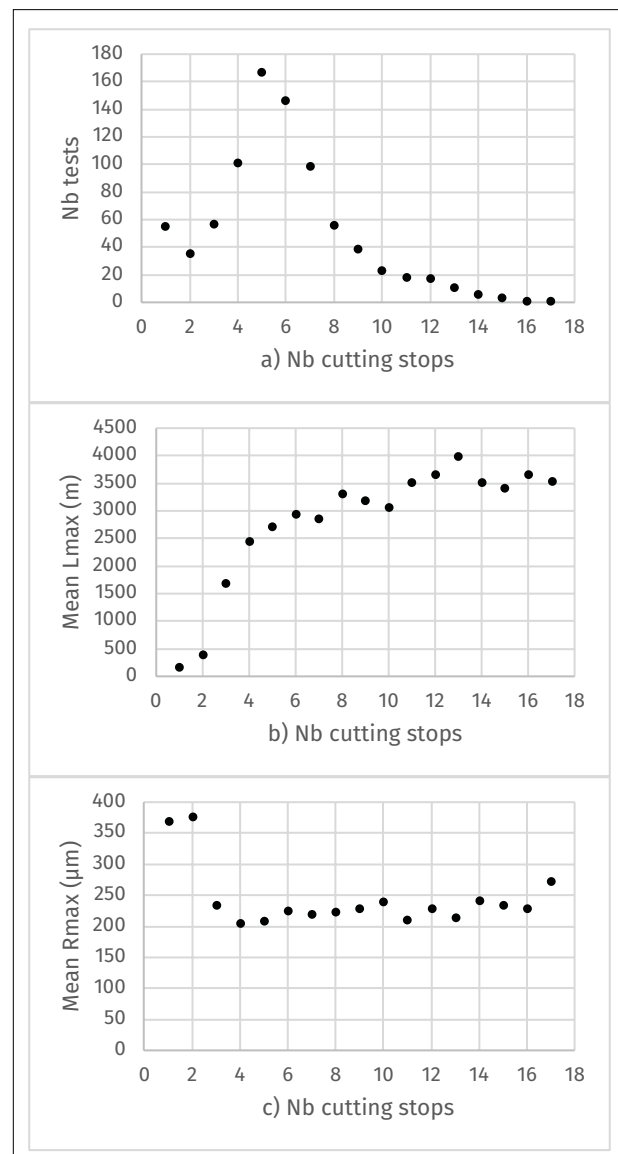

Figure 7.

Number of tests, mean L_{max} and R_{max} per number of cutting stops.

L_{max} : maximum cutting length (m); R_{max} : maximum tool tip recession (μm).

Table I.

Statistical description of the main data for the standard tests.

	Min	Max	Med	Mean	CV
AB	0.10	28.55	4.00	5.5	80%
SG	0.26	1.31	0.72	0.72	26%
Si	10	25600	130	1039	273%
MC	5.0	184	20.8	31.5	81%
R1/L1	0.00	32.8	0.24	0.74	288%
Rm/Lm	0.003	32.8	0.087	0.55	376%
1/m	0.06	26.0	2.33	3.45	95%
Lmax	16	6984	2830	2534	53%
Rmax	9	1000	243	235	54%
n	1	17	6	5.8	48%
Cste	0.00	109	1.4	5.6	202%
Exp	0.05	2.60	0.65	0.65	45%
R ²	0.58	1.00	0.98	0.96	6%
Rcal	0.21	3277	29	73	265%

Min: minimum value; Max: maximum value; Med: median value; Mean: mean value; CV: coefficient of variation of the values; AB: alcohol-benzene extracts (%); SG: specific gravity; Si: silica content (ppm); MC: moisture content (%); R1/L1, Rm/Lm: wear ratios between tool tip recession and cutting length at the beginning and at the end of test; 1/m: ratio between first and last wear ratio; Lmax: maximum cutting length; Rmax: maximum tool tip recession; n: number of cutting stops; Cste: constant parameter in the power law; Exp: exponent in the power law; R²: regression coefficient of the power law; Rcal: calculated values of tool tip recession by the power formula at a given low cutting length, 100 m.

Given the vast range of wood parameters (AB, SG, Si and MC), their common logarithm values were used for the histograms. Specific gravity and wear had a unimodal distribution, while there were clearly two populations for both moisture content (dry and green woods) (figure 8) and silica content (non-siliceous and siliceous woods) (figure 9).

Looking at the correlation table for common logarithm values (table II) for the wood indicators (AB, SG, Si, MC),

Table II.

Correlation table for all standard tests in common logarithm values.

n=835	AB	SG	Si	MC	R1/L1	Rm/Lm	1/m	Lmax	Rmax	Rcal
AB	1.00	0.09	-0.18	-0.05	-0.11	-0.08	0.06	0.07	-0.06	-0.09
SG	*	1.00	0.01	-0.03	0.41	0.32	0.05	-0.23	0.28	0.40
Si	***	*	1.00	0.03	0.41	0.40	-0.20	-0.36	0.35	0.41
MC	ns	ns	ns	1.00	-0.30	-0.13	-0.16	0.21	-0.04	-0.37
R1/L1	**	***	***	***	1.00	0.73	0.01	-0.68	0.59	0.95
Rm/Lm	*	***	***	**	***	1.00	-0.60	-0.86	0.85	0.66
1/m	ns	ns	***	***	ns	***	1.00	0.49	-0.52	ns
Max L	*	***	***	***	***	***	***	1.00	-0.57	-0.64
max R	ns	***	***	ns	***	***	***	***	1.00	0.51
Rcal	**	***	***	***	***	***	ns	***	***	1.00

AB: alcohol-benzene extracts (%); SG: specific gravity; Si: silica content (ppm); MC: moisture content (%); R1/L1, Rm/Lm: wear ratios between tool tip recession and cutting length at the beginning and at the end of test; 1/m: ratio between first and last wear ratios; Lmax: maximum cutting length; Rmax: maximum tool tip recession; Rcal: calculated values of tool-tip recession by the power formula at a given low cutting length, 100 m. Significance codes: 0 < *** < 0.001 < ** < 0.01 < * < 0.05.

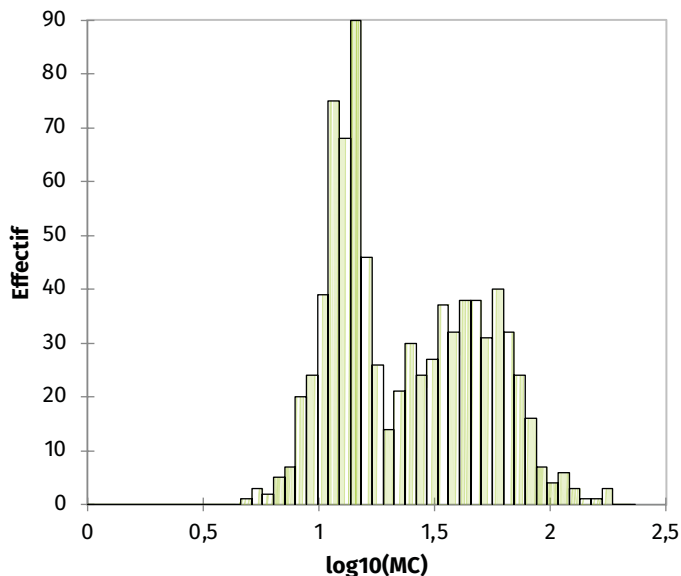
**Figure 8.**

Histograms of values for moisture content. MC: moisture content; log10: common logarithm.

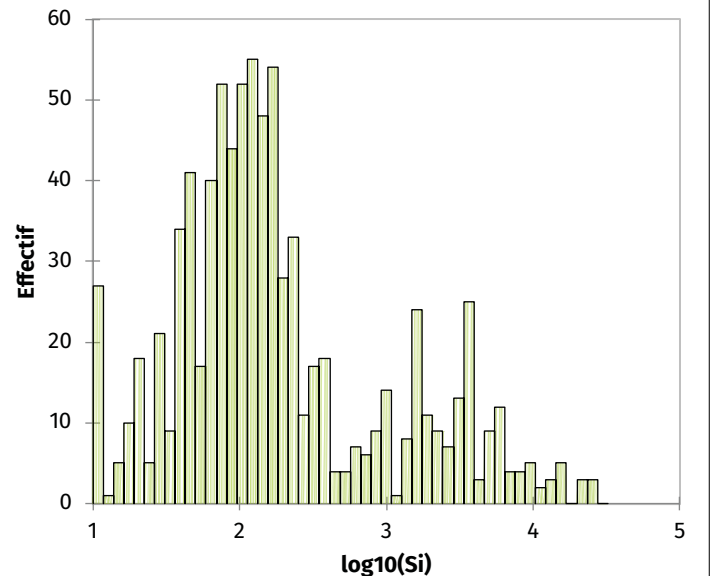
**Figure 9.**

Histograms of values for silica. Si: silica content; log10: common logarithm.

only extractive and silicate contents were significantly correlated. A very high level of correlation was found within wear parameters. Rcal and 1/m will be further regarded as independent parameters. Extractive content only showed a relatively low, but significant, negative correlation with tool wear, while SG, Si, and MC all exhibited high correlation levels, with positive correlations for SG and Si and negative correlations for MC.

Correlation table III shows that Rcal was strongly correlated with initial wear (R1/L1), while R1km was closer to final wear (Rm/Lm). However, the level of correlation between this parameter and silica content was much lower than for all tests.

**Segmentation of the tests
 by tool tip bending occurrence, silica
 and moisture content.**

Firstly, the global dataset was segmented by tool tip bending occurrence, burning of tool face occurrence, moisture content below or over 25%, and silica content below or over 400 ppm (table IV).

Tool tip bending occurred in 22% of all standard tests, primarily in non-siliceous, dry species (42%). Bending cases were more common for high-density values within this segment (Dry nSi), where tool wear was higher at a 100 m cutting length, while the power law exponent was lower, and the 1/m ratio was higher. The very early occurrence of tip bending had a strong influence on the entire process of tool wear, suggesting that these tests should be eliminated from subsequent analyses.

Burning of tool faces occurred in 26% of all standard tests (one-third of each type of test had both bending and burning occurrences), mainly for dry species (42%). Burning occurrence (without bending) was noted but not used to eliminate the burning cases.

Green specimens (characterised by high moisture content) occurred in 46% of all standard tests for species with similar density, AB, or silica content. They had lower tool wear, a higher power law exponent and consequently a higher 1/m ratio. The occurrence of both bending and burning was far lower for green wood.

Siliceous specimens (high silica content) occurred in 24% of all standard tests for species with a similar density, AB, or silica content. They had significantly higher tool wear, a slightly higher power law exponent, and consequently a slightly higher 1/m ratio. The occurrence of bending was significantly lower for siliceous wood, while the occurrence of burning was similar for both high and low silica content.

Table III.

Correlation table for cutting lengths > 500m in common logarithm values.

n=724	SG	Si	MC	R1/L1	Rm/Lm	Rcal	R1km
SG	1	-0.014	-0.074	0.49	0.38	0.47	0.46
Si	ns	1	0.065	0.18	0.15	0.19	0.19
MC	*	ns	1	-0.32	-0.10	-0.42	-0.21
R1/L1	***	***	***	1	0.61	0.93	0.77
Rm/Lm	***	***	ns	***	1	0.51	0.93
Rcal	***	***	***	***	***	1	0.72
R1km	***	***	***	***	***	***	1

SG: specific gravity; Si: silica content (ppm); MC: moisture content (%); R1/L1, Rm/Lm: ratios between tool tip recession and cutting length at the beginning and at the end of test; Rcal, R1km: calculated values of tool-tip recession by the power formula at two given low cutting lengths, 100 m and 1 km, respectively.
 Significance codes: 0 < *** < 0.001 < ** < 0.01 < * < 0.05.

Table IV.

Mean values of wood parameters and wear results for each type.

Segment	Nb	%	Bur	Re	AB	SG	MC	Si	Rcal	1/m	Exp
Dry nSi Re0	201	58%	42	0	5.9	0.68	14.2	104	29.1	3.64	0.63
Dry nSi Re1	144	42%	44	100	5.8	0.80	12.8	118	48.2	5.61	0.44
Dry Si Re0	99	90%	41	0	4.4	0.70	13.9	4000	299	2.13	0.63
Dry Si Re1	11	10%	18	100	6.9	0.79	14.5	996	165	6.32	0.44
Green nSi Re0	261	90%	4	0	5.9	0.70	55	111	17.8	3.02	0.73
Green nSi Re1	29	10%	14	100	4.5	0.81	41	158	24.9	3.59	0.66
Green Si Re0	87	97%	9	0	4.1	0.74	52	4395	140	1.80	0.76
Green Si Re1	3	3%	0	100	10.1	0.78	29.7	2150	57	3.79	0.44
Dry	455	54%	42	34	5.6	0.73	13.7	978	97.1	4.00	0.56
Green	380	46%	6	8	5.4	0.72	52.7	1112	46.6	2.79	0.73
Si < 400	635	76%	26	27	5.8	0.72	31.8	113	28.6	3.83	0.63
Si > 399	200	24%	26	7	4.5	0.72	30.5	3979	219	2.24	0.67
Re0	648	78%	22	0	5.4	0.70	35.5	1278	80.6	2.91	0.69
Re1	187	22%	37	100	5.7	0.80	17.6	208	51.5	5.31	0.47
Bur0	622	74%	0	19	5.7	0.72	36.4	1102	66	3.39	0.65
Bur1	213	26%	100	32	4.8	0.73	16.9	854	97	3.63	0.59
Total	835	100%	26	22	5.5	0.72	31.5	1039	74.1	3.45	0.64
Lmax > 500 m	724	87%	25	25	5.7	0.72	32.2	403	128	3.80	0.64

Nb: number; Re: tool tip bending occurrence; AB: alcohol-benzene extracts (%); SG: specific gravity; MC: moisture content (%); Si: silica content (ppm); Rcal: calculated values of tool-tip recession by the power formula at a given low cutting length, 100 m; 1/m: ratio between first and last wear ratios; Exp: exponent in the power law; nSi: non-siliceous wood (Si < 400); Re0: no tool tip bending; Re1: tool tip bending occurrence; Bur0: no tool burning; Bur1: tool burning occurrence; L max: maximum cutting length.

For 87% of all tests the long-term criteria R1km were calculated (table III). When compared to all tests (Total), all mean values of parameters (AB, SG, MC) and wear profile descriptors (1/m and exponent of the power law) were the same, except for mean silica content (Si), which was 2.5 times lower for the 724 long tests. This means that many samples with a high silica content were not considered in the R1km wear value, which explains the lower coefficient of correlation with Si.

Typical regression curves for the different test categories are shown in figure 10, showing the Rcal value for a

100 m cutting length. Rcal is a downward extrapolation for all types but often an upward extrapolation for dry siliceous woods. With early tool tip bending, the first value of recession was relatively high. However, tool tip recession grew very slowly thereafter, explaining both the high value of 1/m (above five on average) and the low power law exponent (below 0.5 on average).

Siliceous samples (24% of the whole dataset) belonged to 42% of botanical families, 28% of botanical genera and 25% of botanical species. Only four families contained at least five siliceous genera in the tests (half of the total tests):

Caesalpiniaceae, Sapotaceae, Burseraceae and Lauraceae. Very often, when a genus was considered as siliceous, all the species of the genus were siliceous.

Prediction of wear by wood properties

This analysis involved tests without tool tip bending, using the common logarithm of properties and wear.

The influence of silica content (figure 11) was very different between non-siliceous (little positive influence) and siliceous samples (strong positive influence). Wear was 6 times greater for a silica content of 1% as compared to a silica content of 0.1%.

The influence of moisture content on wear (figure 12) was very similar (negative) for both siliceous and non-siliceous samples. In this case, wear was 2.6 times greater for a moisture content of 10% as compared to

a moisture content of 100%.

The influence of specific gravity on wear (figure 13) was very similar (positive) for both siliceous and non-siliceous samples. In this case, wear was 4.4 times lower for a specific gravity of 0.3 as compared to a specific gravity of 0.9.

A linear stepwise regression of wear by sample parameters (AB, SG, MC and Si) using a common logarithm was used to predict wear:

$$\log(Rcal) = 1.43 + 0.435 \times \log(Si) - 0.502 \times \log(MC) + 1.28 \times \log(SG) - 0.107 \times \log(AB)$$

with a final regression coefficient R^2 equal to 58%, primarily due to silica content influence (42%), with moisture content (8%) and specific gravity (7%) having a very significant contribution. In comparison, the contribution of the extractive content was very low (0.4%) but statistically significant (table V).

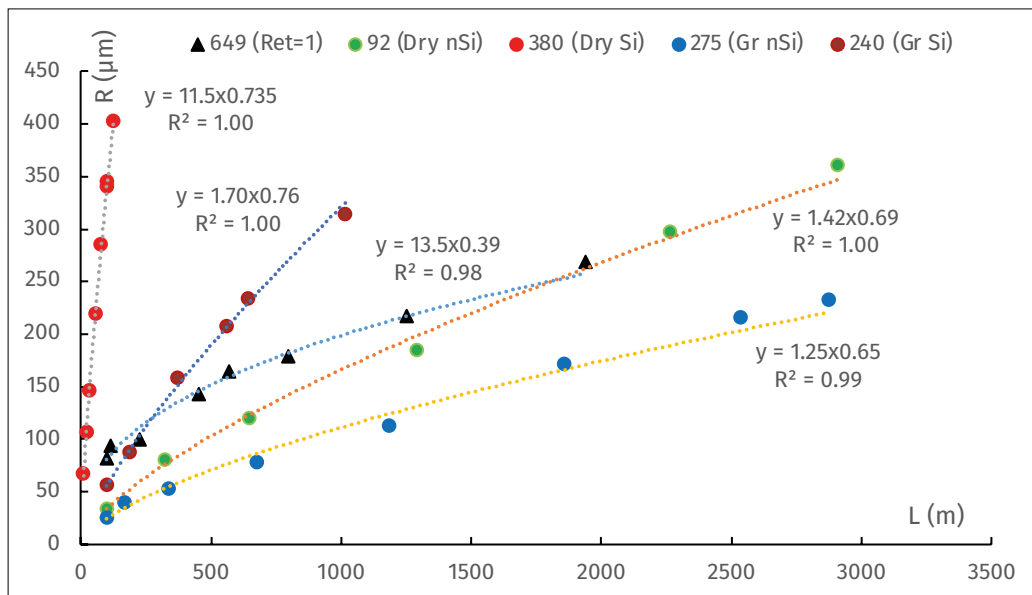

Figure 10.

Examples of typical curves R(L) for different test segments.

Ret = 1: tool tip bending occurrence; Dry nSi: non-siliceous dry wood; Dry Si: siliceous dry wood; Gr nSi: non-siliceous green wood; Gr Si: siliceous green wood; R (μ m): tool tip recession; L (m): cutting length; R^2 : regression coefficient of the power law.

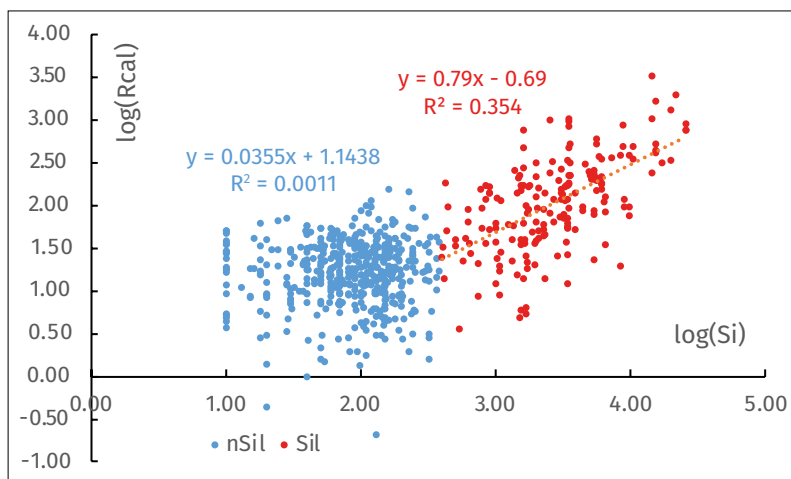
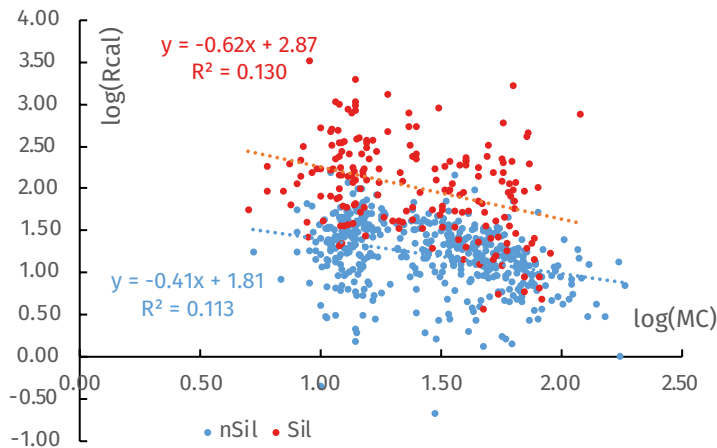

Figure 11.

Relationship between silica content and wear.

Rcal: calculated values of tool-tip recession by the power formula at a given low cutting length, 100 m; Si: silica content; R^2 : regression coefficient of the linear law.

**Figure 12.**

Relationship between moisture content and wear. Rcal: calculated values of toot-tip recession by the power formula at a given low cutting length, 100 m; MC: moisture content; R²: regression coefficient of the linear law.

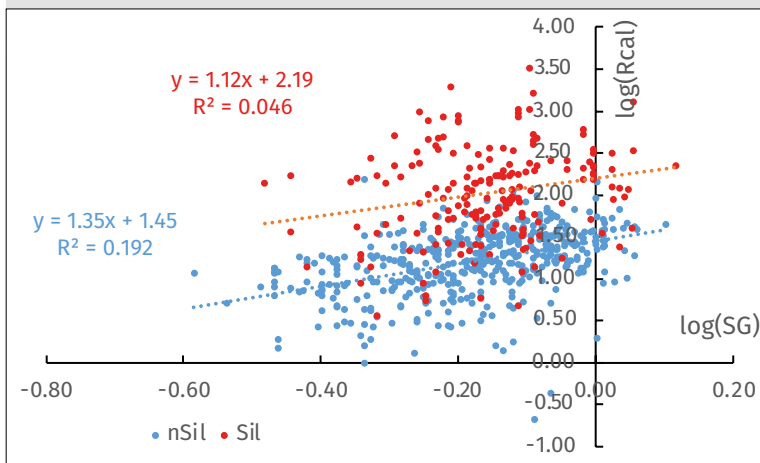
**Figure 13.**

Relationship between specific gravity and wear. Rcal: calculated values of toot-tip recession by the power formula at a given low cutting length, 100 m; SG: specific gravity; R²: regression coefficient of the linear law.

Table V.

Linear regression for 649 tests without tool tip bending.

Parameter	Coefficient	Significance	R ²
Constant	1.43	***	
log(Si)	0.435	***	0.424
log(MC)	-0.502	***	0.504
log(SG)	1.28	***	0.573
log(AB)	-0.107	**	0.577

Logarithm of values were used; Si: silica content (ppm); MC: moisture content (%); SG: specific gravity; AB: alcohol-benzene extracts (%). R²: regression coefficient; Significance codes: 0 < *** < 0.001 < ** < 0.01 < * < 0.05.

Discussion

Cutting forces

Tool wear profiles showed that both the rake face and clearance face were subjected to wear for green siliceous (figure 14a) or non-siliceous (figure 14b) woods, meaning that forces were exerted on the two faces from the very beginning: rake force (rF) and clearance force (cF). These forces depend on wood properties, mainly on wood specific gravity (Kivimaa 1950; Eyma et al. 2005; Marchal et al. 2009).

The tangential components of these forces, rFt and cFt (figure 14c), were the friction forces exerted on each face. They were proportional to the friction coefficient between the tool steel and wood, as well as to the specific gravity. The friction coefficient between steel and wood depends on moisture content (Atack & Tabor 1958), on the cutting speed for wet wood (Thibaut et al. 2016), and on the wood species (Bowden & Tabor 1956; Guan et al. 1983; Beauchêne 1996). The friction coefficient is significantly lower for green wood than for dry wood at high speeds, and it can be even lower with “self-lubricated” species such as *Lignum vitae* or Grignon Franc, *Sextonia rubra*. The values of the friction coefficient can vary from single to double in each case; there are no databases on the friction between steel and the large number of species in this study.

Degradation of the tool tip

Initially, with a sharp tool, the risk of buckling for the tool tip under the action of forces was relatively high, which explains the bending that occurs on either side of the tip (figure 14d). Thus, it should be more frequent for dry wood and a higher specific gravity (table IV). For a high silica content associated with a high wear level, the occurrence of bending was very low. The hypothesis behind this could be related to the very fast blunting of the tool tip, which quickly becomes less prone to local buckling. Tool wear at the start of cutting should be observed to discuss this hypothesis.

The shearing force action on both tool faces produces heating energy proportional to the respective values. This heating is evacuated through wood and steel. Dry wood is a poor conductor of heat, and its local temperature at the point of contact with the tool faces can increase rapidly, causing traces of steel face burning. This is not the case for wet wood, where open water dissipates much of the heat generated by the cutting process.

Abrasive wear

Abrasive wear is induced by the progressive grinding of the tool edge, removing material from the tool through a shearing action of friction forces (Chardin & Froidure 1962; Chardin & Froidure 1968b; Challen & Oxley 1979). The friction angle at high cutting speed (22 m/s) is lower for wet woods due to the lubricating effect of open water in the cell lumens of wet wood (Atack & Tabor 1958).

Abrasive wear is linked to the value of these shearing forces, and abrasive tool wear appears to be higher for denser woods. The shearing forces, given cutting force values (F_a and F_d), are lower for lower friction angles (in wet woods), and abrasive tool wear appears to be lower for wet woods.

Abrasive wear is significantly increased by the presence of very hard particles, such as silica bodies (Okai et al. 2006), embedded in the wood substance, which then act as a form of sandpaper. It appears to be significantly greater for siliceous woods (Richter 1980; Santana et al. 2013), where the silica content is approximately 40 times higher than in non-siliceous woods (table IV).

The silica bodies in the samples were not characterised in detail, and their geometry (size and morphology) could have had an impact on their influence on tool wear. Most of the time, silica body diameters observed in parenchyma cells are lower than 10 μm (Carlquist 2003), but elongated prisms as large as 50 μm can also be present in Lauraceae (Richter 1980).

The mineral content in woods is also important for many species rich in calcium oxalate crystallites, such as *Ceiba pentandra*, *Azelia bella*, or *Milicia excelsa* (Wheeler 2011), which have a high ash content but low silica content (Gérard et al. 2019). The tool wear values measured in this study were not high for such woods, which are known to have high calcium mineral contamination. Calcium oxalate crystals are probably less hard than steel and easy to disintegrate under the action of the tool tip.

Corrosive wear

Acidity and extractive content act as corrosive agents against metals, and crack occurrence at the tool tip can be promoted by stress corrosion mechanisms (Darmawan et al. 2011; Gauvent 2006; Klamecki 1979; Mohan & Klamecki 1981; Porankiewicz 2008). Since tool wear in this dataset was negatively correlated with moisture content and only poorly correlated with extractive contents, it did not appear to be significant in the context of these tests. However, the chemical nature of some organic molecules in the extractives was not known and recent literature on electrochemical corrosion of metals has shown that some of these molecules produce corrosion resistance in mild steel (Chevalier et al. 2014) or inhibit corrosion for C38 steel (Lebrini et al. 2010; Lebrini et al. 2011).

Developments to prevent tool wear

The most common tool material remains forged tempered steel. However, there is a huge variety of blade steels with varying hardness (more resistant to wear), toughness (more resistant to shock) and chemical composition (more resistant to heat or corrosion). Very hard and heat-resistant materials, such as carbides, ceramics or diamond, are increasingly being used for secondary processing operations, but only with wedge angles above 40° and primarily for homogeneous wood-based materials. Aside from handmade steel tools, which utilise all available skills in steel alloy composition, steel forging, and tool tempering, various coating techniques have been employed to enhance the cutting lifetime of industrial high-speed steel commonly used in metal

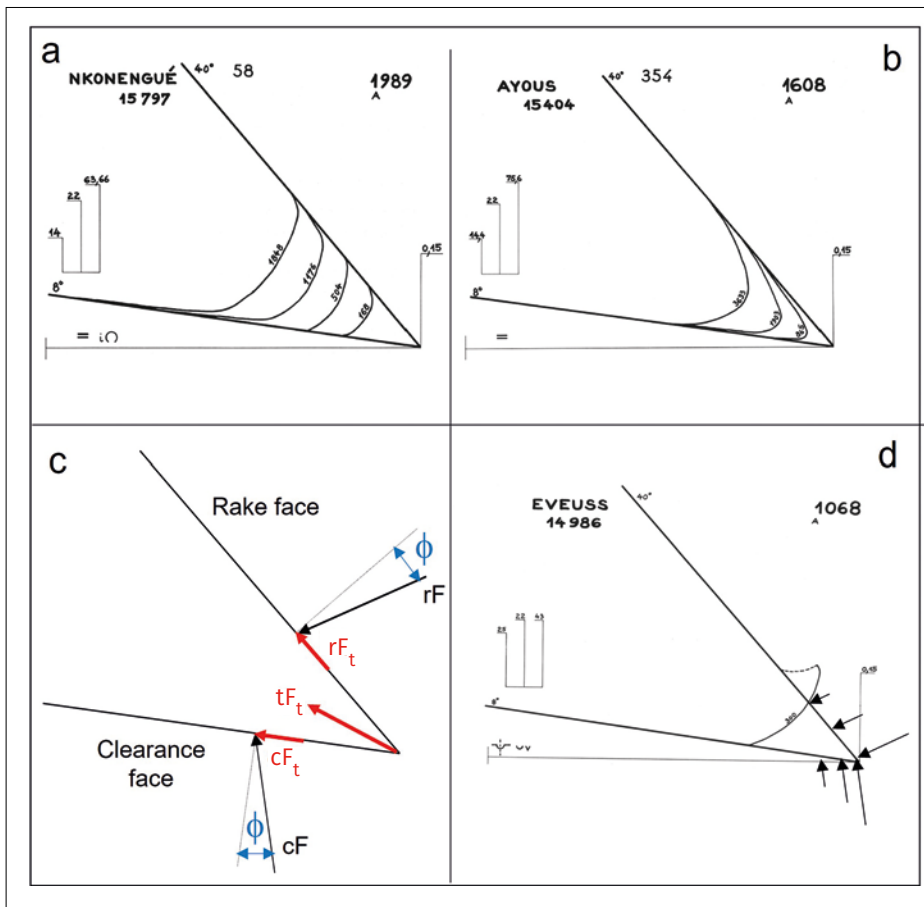

Figure 14.

Analysis of wear phenomena at tool tip level.

a: green state and siliceous wood; b: green state and non-siliceous wood (Chardin & Froidure, 1969); c: forces exerted by wood sample on the tool tip; d: example of upper tool tip bending wood (Chardin & Froidure, 1969). cF , rF : tool force on clearance and rake face; cF_t , rF_t : tangential component of tool force on clearance and rake face; tF_t : sum of the two tangential components. ϕ friction angle between wood sample and tool steel.

cutting, or low-alloy-resistant steel (Nouveau et al. 2009). Stellite tipping is one of the oldest methods and is very efficient for sawing high-density siliceous tropical woods (Chardin & Froidure 1962). Nitriding steel gives promising results (Nouveau et al. 2009; Fahrussiam et al. 2016). A thin coating of a rigid material (CrN type) produced by physical vapour deposition also yields promising results (Nouveau et al. 2001).

Grinding and honing are frequent and delicate operations throughout tool life, and final manual honing remains the best preparation before cutting. In fact, even after excellent classical grinding, the tool edge is rather rough (Meyer 2003) at its tip, with very tiny cracks that lead to damage in the first cutting lengths.

The issue of improving the performance of cutting tools dedicated to woodworking remains vast today (Muhammed et al. 2023), since this problem, which was already clearly identified in the 1960s, linked to the extreme wear generated by the machining of certain types of wood, is so pressing for the industry.

This obviously requires a detailed understanding of the phenomenon, to which the rich CTFT databases can contribute.

Conclusion

In wood cutting operations, where only wood species and moisture content vary as parameters, a significant variability in tool wear was observed, partly due to early tool tip deterioration and partly due to abrasion. Friction forces exerted by the wood material on the top and faces of the tool tip are one of the driving phenomena, the second is the grinding action of hard mineral “contamination” present in wood cells, and the third is metal degradation by stress corrosion.

Using a linear progressive regression procedure on a parameter logarithm, nearly 60% of tool wear variability was explained by changes in silica content (for 42%), wood moisture content (for 8%), wood specific gravity (for 7%) and organic extractives (for 0.4%). 40% remained random in nature. Some of these residual errors are due to variability within the successive wood blocks of a single test. Significant anatomical variations in siliceous corpuscles within species can influence tool wear, and our knowledge of the more macroscopic distribution of silica content in wood and throughout the tree is limited. Another part is inherent to the method. Tool tip recession is measured at a single position along the tool edge, and this position can be a localised zone of tool degradation. A significant portion of random uncertainty is inevitable in this type of study.

More surprisingly, the global occurrence of organic extractives had nearly no residual impact, whereas many extractives are known to influence steel corrosion and friction coefficients strongly. Due to the large panel of species and genera tested, extractives with a positive or negative impact on corrosion or friction ought to have been present in the tests, cancelling out any visible influence of AB

content. There is a need for more in-depth chemical analysis of extractives and minerals in wood species. One way to proceed may be to examine the species poorly described by the linear regression. Duplicate specimens from the CIRAD wood collection (Langbour et al. 2019) of the same tree could be used to undertake a detailed chemical analysis.

Acknowledgements

We would like to thank all the former members of the Machining Division of the Tropical Forestry Technical Centre, without whom these saw tooth wear tests could not have been carried out, in particular A. Marouteix for manufacturing the experimental devices and sharpening the tools, A. Grossmann for designing the experimental devices and drawing the wear profiles, and J. Chatelain for photographing the tool edges.

Funding

The saw tooth wear tests were conducted at the Tropical Forestry Technical Centre, mainly self-financed by the Machining Division.

Access to data

Data are freely available and have been uploaded to the CIRAD dataverse: <https://doi.org/10.18167/DVN1/RYL99A>

References

- Alm eras, T., Jullien, D., Liu, S., Loup, C., Gril, J., & Thibaut, B. (2025). The diversity of radial variations of wood properties in European beech (*Fagus sylvatica* L.) reveals the plastic nature of juvenile wood. *Annals of Forest Science*, 82(1), 15. <https://doi.org/10.1186/s13595-025-01284-9>
- Atack, D., & Tabor, D. (1958). The friction of wood. *Proceedings of the Royal Society of London. Series A. Mathematical and Physical Sciences*, 246(1247), 539–555. <https://doi.org/10.1098/rspa.1958.0163>
- Beauch ene, J. (1996). * volution du comportement m canique du bois vert avec la temp rature : Application   l' tude du d roulage de quelques bois guyanais*. Th se de doctorat,  cole nationale du g nie rural, des eaux et des for ts, France. https://agritrop.cirad.fr/540374/1/document_540374.pdf
- Bowden, F. P., & Tabor, D. (1958). *Friction and lubrication*. London, UK: Methuen.
- Candelier, K., G rard, J., Th venon, M.-F., & Thibaut, B. (2023). Survey on the natural resistance to decay of five hundred tropical wood species. *Bois et For ts des Tropiques*, 358, 53–65. <https://doi.org/10.19182/bft2023.358.a37353>
- Carlquist, S. (2003). Wood anatomy of Polygonaceae: Analysis of a family with exceptional wood diversity. *Botanical Journal of the Linnean Society*, 141(1), 25–51. <https://doi.org/10.1046/j.1095-8339.2003.00100.x>

- Catinot, R. (1994). *Le Centre technique forestier tropical 1916–1984*. Montpellier, France: CIRAD, 177 p. https://agritrop.cirad.fr/311976/1/document_311976.pdf
- Challen, J. M., & Oxley, P. L. B. (1979). An explanation of the different regimes of friction and wear using asperity deformation models. *Wear*, 53(2), 229–243. [https://doi.org/10.1016/0043-1648\(79\)90080-2](https://doi.org/10.1016/0043-1648(79)90080-2)
- Chardin, A. (1954). Peut-on scier tous les bois avec la même denture? *Bois et Forêts des Tropiques*, 33, 41–50. <https://revues.cirad.fr/index.php/BFT/article/view/18559>
- Chardin, A. (1958). Utilisation du pendule dynamométrique dans les recherches sur le sciage des bois tropicaux. *Bois et Forêts des Tropiques*, 58, 49–61. <https://revues.cirad.fr/index.php/BFT/article/view/18728>
- Chardin, A. (1966). L'étude de l'usure des dents de scie. Chapitre I : nécessité d'une étude de l'usure et choix d'une méthode de travail. *Bois et Forêts des Tropiques*, 110, 57–66. <https://revues.cirad.fr/index.php/BFT/article/view/18971?articlesBySameAuthorPage=2>
- Chardin, A. (1967a). L'étude de l'usure des dents de scie. Chapitre I : nécessité d'une étude de l'usure et choix d'une méthode de travail. *Bois et Forêts des Tropiques*, 114, 65–72. <https://revues.cirad.fr/index.php/BFT/article/view/19010>
- Chardin, A. (1967b). L'étude de l'usure des dents de scie. Chapitre I : nécessité d'une étude de l'usure et choix d'une méthode de travail. *Bois et Forêts des Tropiques*, 115, 55–67. <https://revues.cirad.fr/index.php/BFT/article/view/19004>
- Chardin, A., & Froidure, J. (1962). L'utilisation des lames de scies à dents stellitées. Choix du grade et des conditions de coupe. *Bois et Forêts des Tropiques*, 85, 41–54. <https://revues.cirad.fr/index.php/BFT/article/view/18848?articlesBySameAuthorPage=2>
- Chardin, A., & Froidure, J. (1967). Étude de l'usure des dents de scie. Chapitre II : mise en œuvre de la méthode adoptée. *Bois et Forêts des Tropiques*, 116, 15–30. <https://revues.cirad.fr/index.php/BFT/article/view/18995?articlesBySameAuthorPage=2>
- Chardin, A., & Froidure, J. (1968a). Étude de l'usure des dents de scie. Chapitre II : mise en œuvre de la méthode adoptée. *Bois et Forêts des Tropiques*, 120, 49–65. <https://revues.cirad.fr/index.php/BFT/article/view/19036>
- Chardin, A., & Froidure, J. (1968b). Étude de l'usure des dents de scie. Chapitre III : mode de publication des résultats. *Bois et Forêts des Tropiques*, 122, 41–58. <https://revues.cirad.fr/index.php/BFT/article/view/19027>
- Chardin, A., & Froidure, J. (1969). *Étude de l'usure des dents de scie, Volume 1 – Influence des taux d'humidité des bois et de l'épaisseur des copeaux*. Nogent-sur-Marne, France : Centre Technique Forestier Tropical, 388 p. <https://agritrop.cirad.fr/608684/1/Etude%20de%20l%27usure%20des%20dents%20de%20scie%20-%20volume%201.pdf>
- Chardin, A., & Froidure, J. (1970). *Étude de l'usure des dents de scie, Volume 2 : Influence de la vitesse de coupe*. Nogent-sur-Marne, France : Centre Technique Forestier Tropical, 292 p.
- Chevalier, M., Robert, F., Amusant, N., Traisnel, M., Roos, C., et al. (2014). Enhanced corrosion resistance of mild steel in 1 M hydrochloric acid solution by alkaloids extract from *Aniba rosaeodora* plant: Electrochemical, phytochemical and XPS studies. *Electrochimica Acta*, 131, 96–105. <https://doi.org/10.1016/j.electacta.2013.12.023>
- Darmawan, W., Rahayu, I., Nandika, D., & Marchal, R. (2011). Wear characteristics of wood cutting tools caused by extractive and abrasive materials in some tropical woods. *Journal of Tropical Forest Science*, 23(4), 345–353. <https://www.researchgate.net/publication/270162878>
- Eyma, F., Méausoone, P. J., Larricq, P., & Marchal, R. (2005). Utilization of a dynamometric pendulum to estimate cutting forces involved during routing: Comparison with actual calculated values. *Annals of Forest Science*, 62(5), 441–447. <https://doi.org/10.1051/forest:2005040>
- Fahrussiam, F., Praja, I. A., Darmawan, W., Wahyudi, I., Nandika, D., Usuki, H., & Koseki, S. (2016). Wear characteristics of multilayer-coated cutting tools in milling wood and wood-based composites. *Tribology in Industry*, 38(1), 66. <https://www.tribology.rs/journals/2016/2016-1/7.pdf>
- Gauvent, M. (2006). *Optimisation de la durée de vie d'un outil de coupe pour l'industrie du bois : Analyse et compréhension des modes d'usure : Mise au point de solutions innovantes avec tests industriels*. Thèse de doctorat, Université Henri Poincaré-Nancy 1, France. <https://hal.science/tel-01748143/>
- Gérard, J., & Narboni, P. (1996). Une base de données sur les propriétés technologiques des bois tropicaux, schéma d'organisation. *Bois et Forêts des Tropiques*, 342, 65–69. <https://revues.cirad.fr/index.php/bft/article/view/19885>
- Gérard, J., Paradis, S., & Thibaut, B. (2019). Survey on the chemical composition of several tropical wood species. *Bois et Forêts des Tropiques*, 248, 79–91. <https://doi.org/10.19182/bft2019.342.a31809>
- Glass, S. V., & Zelinka, S. L. (2010). Moisture relations and physical properties of wood. In *Wood handbook: Wood as an engineering material*. Chapter 4, Centennial ed., pp. 4–1–4–45. Madison, WI, USA: USDA Forest Service, Forest Products Laboratory. https://www.fpl.fs.usda.gov/documnts/fplgtr/fpl_gtr190.pdf
- Guan, N., Thunell, B., & Lyth, K. (1983). On the friction between steel and some common Swedish wood species. *Holz als Roh- und Werkstoff*, 41, 55–60. <https://doi.org/10.1007/BF02612232>
- Kivimaa, E. (1950). *Cutting force in woodworking*. Helsinki, Finland: VTT Technical Research Centre of Finland, 101 p.
- Klamecki, B. E. (1979). A review of wood cutting wear literature. *Holz als Roh- und Werkstoff*, 37, 265–276. <https://doi.org/10.1007/BF02607429>
- Langbour, P., Paradis, S., & Thibaut, B. (2019). Description of the Cirad wood collection in Montpellier, France, representing eight thousand identified species. *Bois et Forêts des Tropiques*, 339, 7–16. <https://doi.org/10.19182/bft2019.339.a31709>

Lebrini, M., Robert, F., Lecante, A., & Roos, C. (2011). Corrosion inhibition of C38 steel in 1 M hydrochloric acid medium by alkaloids extract from *Oxandra asbeckii* plant. *Corrosion Science*, 53(2), 687–695. <https://doi.org/10.1016/j.corsci.2010.10.006>

Lebrini, M., Robert, F., & Roos, C. (2010). Inhibition effect of alkaloids extract from *Annona squamosa* plant on the corrosion of C38 steel in normal hydrochloric acid medium. *International Journal of Electrochemical Science*, 5(11), 1698–1712. [https://doi.org/10.1016/S1452-3981\(23\)15422-8](https://doi.org/10.1016/S1452-3981(23)15422-8)

Marchal, R., Mothe, F., Denaud, L. E., Thibaut, B., & Bleron, L. (2009). Cutting forces in wood machining—Basics and applications in industrial processes: A review COST Action E35 2004–2008: Wood machining—micromechanics and fracture. *Holzforschung*, 63(2), 157–167. <https://doi.org/10.1515/HF.2009.014>

Meyer, B. (2003). *L'affûtage et l'entretien de vos outils à bois main et machine* (Vol. 1). Gorniès, France : Éditions de la Canopée, 96 p.

Mohan, G. D., & Klamecki, B. E. (1981). The susceptibility of wood-cutting tools to corrosive wear. *Wear*, 74(1), 85–92. [https://doi.org/10.1016/0043-1648\(81\)90195-2](https://doi.org/10.1016/0043-1648(81)90195-2)

Muhammed, M., Javidani, M., Heidari, M., & Jahazi, M. (2023). Enhancing the tribological performance of tool steels for wood-processing applications: A comprehensive review. *Metals*, 13(8), 1460. <https://doi.org/10.3390/met13081460>

Nouveau, C., Djouadi, M. A., Decès-Petit, C., Beer, P., & Lambertin, M. (2001). Influence of CrxNy coatings deposited by magnetron sputtering on tool service life in wood processing. *Surface and Coatings Technology*, 142, 94–101. [https://doi.org/10.1016/S0257-8972\(01\)01092-1](https://doi.org/10.1016/S0257-8972(01)01092-1)

Nouveau, C., Labidi, C., Collet, R., Benlatreche, Y., & Djouadi, M. A. (2009). Effect of surface finishing such as sand-blasting and CrAlN hard coatings on the cutting edge's peeling tools' wear resistance. *Wear*, 267(5–8), 1062–1067. <https://doi.org/10.1016/j.wear.2009.01.045>

Okai, R., Tanaka, C., & Iwasaki, Y. (2006). Influence of mechanical properties and mineral salts in wood species on tool wear of high-speed steels and stellite-tipped tools: Consideration of tool wear of the newly developed tip-inserted band saw. *Holz als Roh- und Werkstoff*, 64(1), 45–52. <https://doi.org/10.1007/s00107-005-0015-6>

Porankiewicz, B., Sandak, J., & Tanaka, C. (2005). Factors influencing steel tool wear when milling wood. *Wood Science and Technology*, 39(3), 225–234. <https://doi.org/10.1007/s00226-004-0282-0>

Porankiewicz, B., Iskra, P., Sandak, J., Tanaka, C., & Józwiak, K. (2006). High-speed steel tool wear during wood cutting in the presence of high-temperature corrosion and mineral contamination. *Wood Science and Technology*, 40(8), 673–682. <https://doi.org/10.1007/s00226-006-0084-7>

Porankiewicz, B. K. (2008). High-speed steel tool wear after wood milling in the presence of high temperature tribochemical reactions. *BioResources*, 3(3), 838–858. <https://doi.org/10.15376/biores.3.3.838-858>

Porankiewicz, B., Wieczorek, D., Bocho-Janiszewska, A., & Klimaszewska, E. (2016). An attempt to analyze the influence of properties of five African wood species on cemented carbide tool wearing. *BioResources*, 11(1), 585–598. <https://doi.org/10.15376/biores.11.1.585-598>

Richter, H. G. (1980). Occurrence, morphology and taxonomic implications of crystalline and siliceous inclusions in the secondary xylem of the Lauraceae and related families. *Wood Science and Technology*, 14(1), 35–44. <https://doi.org/10.1007/BF00353461>

Santana, M. A. E., Rodrigues, L. C., Rauber Coradin, V. T., Arakaki Okino, E. Y., & de Souza, M. R. (2013). Silica content of 36 Brazilian tropical wood species. *Holzforschung*, 67(1), 19–24. <https://doi.org/10.1515/hf-2011-0240>

Thibaut, B., Denaud, L., Collet, R., Marchal, R., Beauchêne, J., et al. (2016). Wood machining with a focus on French research in the last 50 years. *Annals of Forest Science*, 73(1), 163–184. <https://doi.org/10.1007/s13595-015-0460-2>

Wheeler, E. A. (2011). Inside wood – A web resource for hardwood anatomy. *IAWA Journal*, 32(2), 199–211. <https://doi.org/10.1163/22941932-90000051>

Gérard et al. – Credit authorship contribution statement

Contributor role	Contributor names
Conceptualisation	B.Thibaut, J. Gérard
Data Curation	J. Gérard, B. Thibaut, R. Curti
Formal Analysis	B. Thibaut
Resources	J. Gérard, B. Thibaut
Visualisation	B. Thibaut, R. Curti
Writing – Original Draft Preparation	B.Thibaut
Writing – Review & Editing	B. Thibaut, R. Curti, J. Gérard

Bois et Forêts des Tropiques - Revue scientifique du Cirad



Cirad - Campus international de Baillarguet,
 34398 Montpellier Cedex 5, France
 Contact : bft@cirad.fr - ISSN : L-0006-579X