



HAL
open science

Polyimide Films for Digital Isolators

Baoxing Chen, Sombel Diaham

► **To cite this version:**

Baoxing Chen, Sombel Diaham. Polyimide Films for Digital Isolators. Intech Open. Polyimide for Electronic and Electrical Engineering Applications, IntechOpen, 2020, 10.5772/intechopen.93343 . hal-04778998

HAL Id: hal-04778998

<https://ut3-toulouseinp.hal.science/hal-04778998v1>

Submitted on 12 Nov 2024

HAL is a multi-disciplinary open access archive for the deposit and dissemination of scientific research documents, whether they are published or not. The documents may come from teaching and research institutions in France or abroad, or from public or private research centers.

L'archive ouverte pluridisciplinaire **HAL**, est destinée au dépôt et à la diffusion de documents scientifiques de niveau recherche, publiés ou non, émanant des établissements d'enseignement et de recherche français ou étrangers, des laboratoires publics ou privés.

Polyimide Films for Digital Isolators

Baoxing Chen¹ and Sombel Diahm^{2,3}

¹Analog Devices Inc., Wilmington, MA, USA

²University of Toulouse, LAPLACE Research Institute, CNRS, Toulouse, France

³Analog Devices International, Limerick, Ireland

Corresponding author: baoxing.chen@analog.com

Abstract

Digital isolators provide compelling benefits over legacy opto-couplers in terms of high speed, low power consumption, high reliability, small size, high integration and ease of use. Billions of digital isolators using micro-transformers have been widely adopted in many markets including automotive, industry automation, medical and energy. What are essential for the high voltage performance for these digital isolators are polyimide films deposited in between the top spiral winding and bottom spiral winding for the stacked winding transformers. In this chapter, digital isolator construction using polyimide films as isolation layers will be reviewed. To meet various safety standards such as UL and VDE, digital isolators need to satisfy various high voltage performances, such as short duration withstand voltage, surge voltage and working voltage. Polyimide aging behavior under various high voltage waveforms such as AC or DC was studied and isolator working voltage is extrapolated through a polyimide lifetime model. Structural improvements to improve polyimide high voltage lifetime will also be discussed.

Keywords: Polyimide films, Digital isolators, High Voltage, Lifetime Model, Charge Injection, Barrier effect.

1. Introduction

Isolation between circuit components is typically required for safety and/or data integrity considerations. For example, isolation protects sensitive circuit components and human interface on the system side from dangerous voltage levels present on the field side, where more robust components such as sensors and actuators reside. Isolation can also eliminate common-mode noises or ground loops that affect data acquisition accuracy. While opto-couplers are choices of isolation for many decades, they present significant limitations in terms of low speed, high power consumption, and limited reliability. Its low bandwidth and long propagation delay presented significant challenges in meeting the ever-increasing speed requirements for many isolated field bus communications such as RS485 in industry automation systems. Its high-power consumption due to the need to lighting up LED puts significant constraint on overall system power budget in power limited industry systems such as process control 4-20 mA systems. As current transfer ratio for the opto-couplers



degrades over time, especially at high temperatures, they fail to meet reliability for demanding application such as automotive.

Digital isolators remove penalties associated with isolation, provide compelling advantages over opto-couplers in terms of high speed, low power consumption, high reliability, small size, high integration and ease of use. Digital isolators using micro-transformers [1, 2] allows the integration of multiple transformers and with other necessary circuit functions. These stacked spirals used in digital isolators provide tight magnetic coupling between the top coil and bottom coil, and very little coupling between spirals side by side. This enables multiple channel integration with little interference between the channels. The magnetic coupling between the top spiral and bottom spiral depends only on the size and separation, unlike the current transfer ratio for the opto-couplers, does not degrade over time, which leads to the high reliability for these digital isolators based on transformers. These transformers have self-resonant frequency from a few hundred MHz to a few GHz, can be easily used to realize digital isolators from 150Mbps to 600Mbps. With high quality factor well over 10 for these transformers, the power consumption for these digital isolators is orders of magnitude lower than those of opto-couplers.

Opto-couplers as shown in Figure 1 rely on a few mm thick molding compound between the LED die and photo-diode die to achieve isolation. For transformer based digital isolators as shown in Figure 2, isolation performance is mainly limited by 20 to 40 μ m thick polyimide layers sandwiched between the top and bottom coils of the chip-scale micro-transformers. In this chapter, we will review detailed construction of these isolators, the deposition methods for these polyimide films, characterization of the polyimide films, the high voltage performance and the aging behavior for the digital isolators.

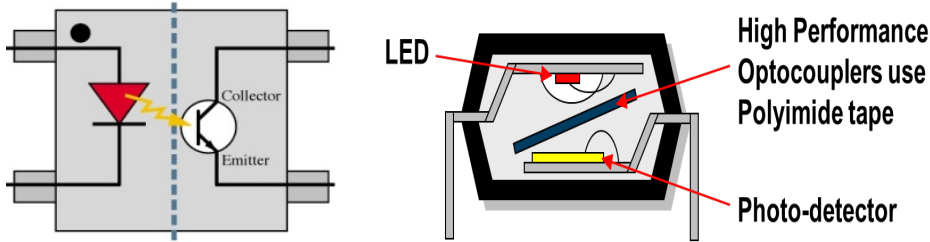

Figure 1. (a) Opto-coupler schematic (b) Opto-coupler package cross-section



Figure 2. (a) Digital isolator in a plastic package (b) Transformer cross-section

Polyimide was chosen as the insulating material for many reasons including excellent breakdown strength, thermal and mechanical stability, chemical resistance, ESD performance, and relatively low permittivity. Besides good high voltage performance, polyimide has excellent ESD performance, capable of handling EOS and ESD events exceeding 15 kV [3]. During energy limited ESD events, the polyimide polymer absorbs some of the charge to form stable radicals that interrupt the

avalanche process and bleeds away some of the charge. Other dielectric materials such as oxide typically do not have this ESD tolerant characteristic and may go into avalanche once the ESD level exceeds the dielectric strength, even if the ESD energy is low. The polyimide also has high thermal stability; with a weight loss temperature over 500°C and a glass transition temperature above 260°C. The polyimide also has high mechanical stability with a tensile strength over 120MPa and a high elastic elongation over 30%. In spite of its high elongation, polyimide does not deform easily, because the Young's Modulus is about 3.3Gpa.

The polyimide has excellent chemical resistance which is one reason it has been widely used for insulation coatings for high voltage cables. High chemical resistance also helps to facilitate IC processing on top of polyimide layers, such as the Au plating used to create *i*Coupler transformer coils. Lastly, the thick polyimide layers, with a dielectric constant of 3.3, work well with the small diameter Au transformer coils to minimize capacitance across the isolation barrier. Most Coupler products exhibit less than 2.5 pF capacitance between input and output. Because of these characteristics, polyimide is increasingly used in microelectronics applications, and it is an excellent choice as insulating material for the *i*Coupler high voltage digital isolators.

2. Digital Isolator Construction and Fabrication

There are three major components for a digital isolator, isolation barrier coupling element, insulation material, and signaling schemes through the isolation barrier. Insulation material is used for the isolation barrier to achieve certain isolation rating and the isolation rating mainly depends on the dielectric strength and its thickness. There are two main types of dielectric materials, organic such as polyimide and inorganic such as silicon dioxide or silicon nitride. Oxide or nitride has excellent dielectric strength of 700-1000V/ μ m, however it has inherent high stress to prevent film thicker than 15-20 μ m to be formed reliably on a large scale modern IC wafer. The other limitation to organic films is that they are susceptible to ESD, a tiny energy of voltage overstress will lead to catastrophic avalanche breakdown. Organic films such as polyimide consist of long C-H chains, small ESD event with limited energy may break some local C-H links without compromising material structural integrity, and they tend to be much more ESD tolerant. Polyimide does not compare favorably to oxide or nitride in terms of dielectric strength, around 400-700 V/ μ m, however with inherent low film stress, much thicker polyimide layers as much as 40-60 μ m can be formed economically. Thus, 30 μ m polyimide films provide withstand voltages 12kV-21kV, comparable to 20 μ m oxide with withstand 14kV-20kV. For applications with robust ESD performance and high voltage withstand capability against impulse voltages such as those present during lightning strikes, polyimide based isolators provide the most robust choice.

Commercial polyimide films are available in photo-resist form that are deposited on wafers with well controlled thicknesses and then easily patterned with standard photolithography processes. Here is the process flow as shown in Figure 3 for the isolation transformers used for the digital isolators. A CMOS wafer with its top metal layer forming the bottom coil is spin coated with the first photosensitive polyimide, the polyimide layer is patterned through photolithography. The polyimide is then thermally cured to achieve high structural quality. Top coil layer is plated after which a second polyimide layer is coated, patterned, and cured to form the encapsulation for the top coil. Because deposited polyimide films are free of voids as shown in Figure 4 and do not suffer from corona discharge, the transformer devices also exhibit good aging behavior and work well under continuous AC voltages and DC voltages.



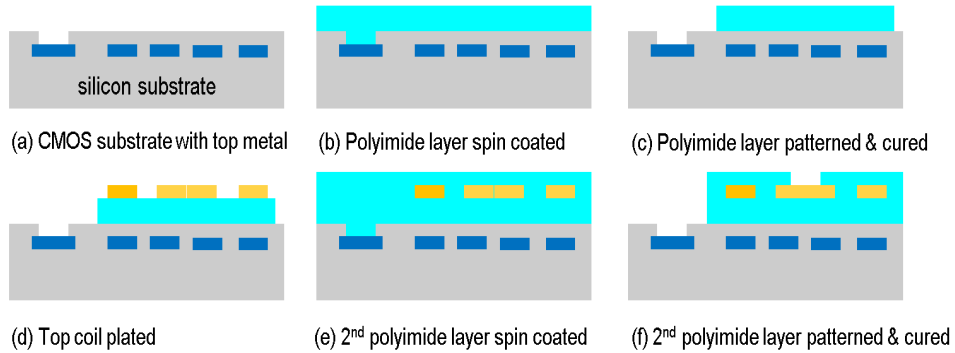

Figure 3. Isolation transformer process flow

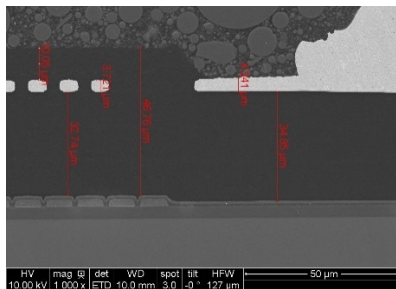

Figure 4. Cross-section for the fabricated isolation transformer

3. High Voltage Performances

Isolation rating is defined by the maximum withstand voltage with 1 minute duration per UL1577. For production test, the digital isolators were tested for 1 second at 120% of rated voltage. For example, for 2.5 kV_{rms} 1min rated digital isolators, the production test is 3 kV_{rms} for 1 second. For practical applications, there are two important high voltage performance parameters, one is the maximum working voltage where the insulation need to be intact over lifetime of continuous operation, AC or DC. For example, per VDE0884-11, the lifetime for isolators with reinforced isolation at 120% of the rated voltage needs to be greater than 37.5 years at 1ppm failure rate. As an example, if the rated working voltage for a reinforced digital isolator is 1 kV_{rms}, its lifetime at 1.2 kV_{rms} needs to be greater than 37.5 years at 1ppm failure rate. Similarly, the lifetime for isolators with basic insulation at 120% of the rated voltage needs to be better than 26 years with 1000 ppm failure. The other important application specification is the maximum transient isolation voltage where the part need to survive. Transient test waveforms may vary, and an example waveform per EN 60747-5-5 or IEC 61010-1 is shown in Figure 5. It rise time from 10 % to 90 % is about 1.2 μs while the falling time from peak to 50 % is 50 μs. This intends to simulate the lightning condition, so it is important for isolators to have robust surge performance to be robust in the field. ESD tolerance is an important attribute for semiconductor devices, and high surge performance also imply excellent ESD performance.



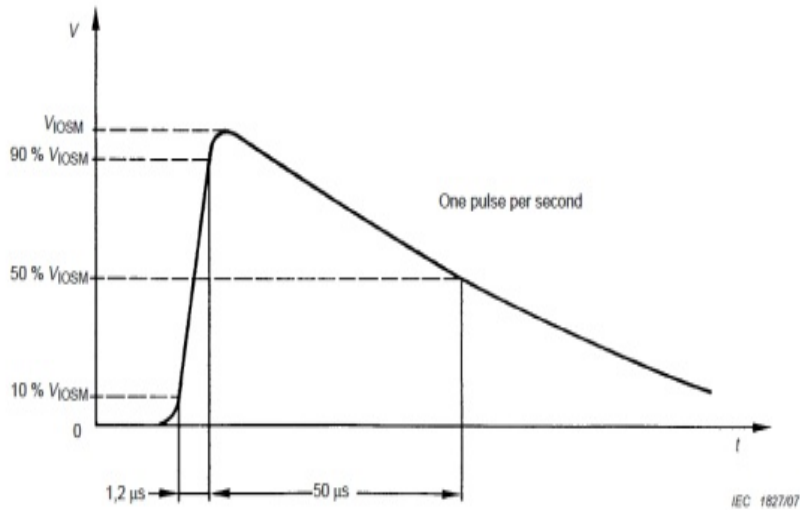

Figure 5. IEC61010-1 Surge test waveform

4. Polyimide Films Characterization

Figure 6 shows the main intrinsic electrical properties of spin-coated polyimide films measured at wafer level. On one hand, the DC bulk conductivity of polyimide shows very low values around 10^{-16} S/m over an applied electric field range up to 40 V/ μm (i.e. ohmic range), but remaining quite low at least up to 150 V/ μm . On the other hand, the AC breakdown field of the polyimide films exhibits a minimum value of 450 V_{rms}/ μm at 60 Hz. All these make spin-coated polyimide films very good insulating materials for reliable digital isolator application.

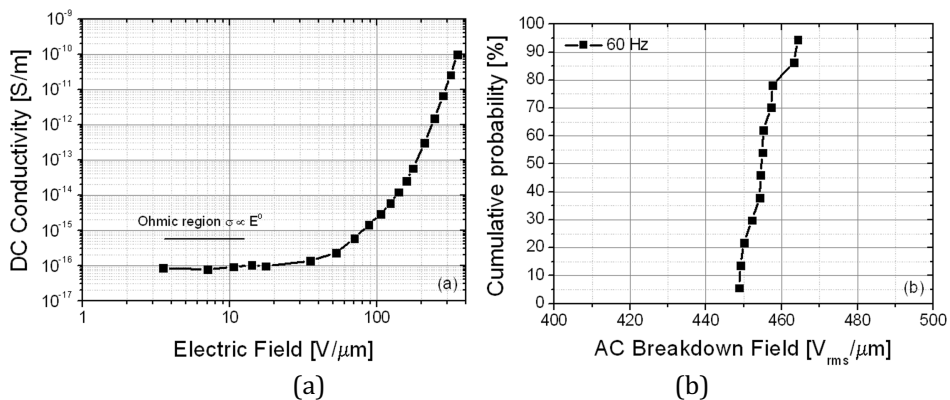

Figure 6. Main intrinsic electrical properties of spin-coated polyimide films measured at wafer level: (a) DC conductivity vs. electric field and (b) AC breakdown field distribution.

Figure 7 shows the surge performance for isolators with 30 μm thick polyimide films. As it can be seen, these isolators will pass surge tests up to 18 kV, and the 1st failure voltage is 19 kV for negative pulse and the 1st failure voltage is 20 kV for positive pulse.

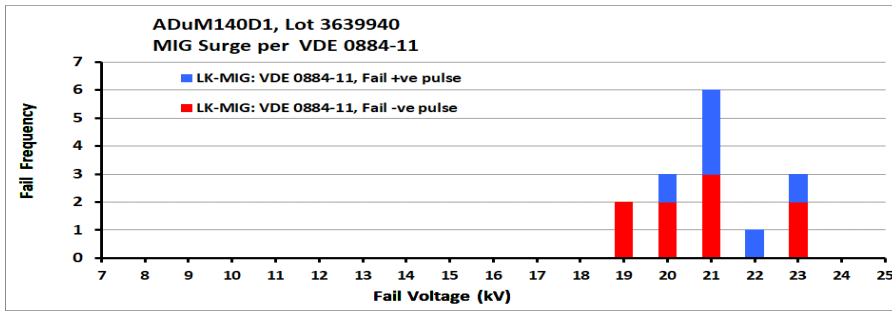

Figure 7. Surge performance for isolators with polyimide films 30 μm-thick

5. Polyimide Aging

Polyimide lifetime is studied through high voltage endurance test. Any insulator, given sufficient time and voltage, will break down. An example setup is shown in Figure 8. Multiple parts are connected electrically in parallel, and multiple groups of parts are stressed in different high voltages from high voltage power supplies, and a switch/measurement unit such as Agilent 34980 together with a PC can be used to monitor the time the number of units have broken down. This can be a time consuming process where it can take days to months for the units to break down.

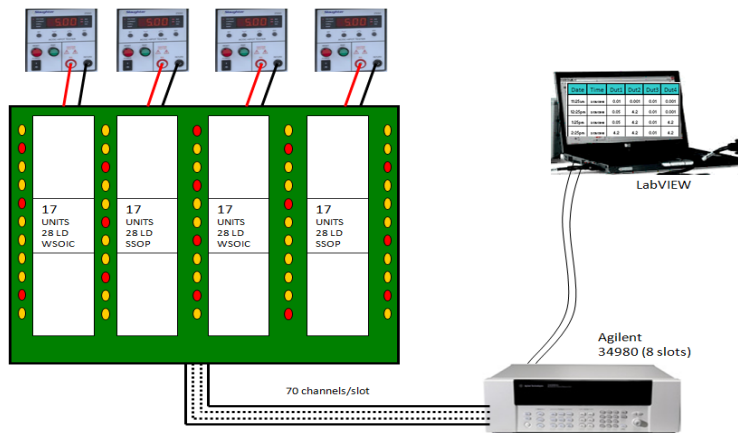

Figure 8. Experimental setup for high voltage endurance test

The distributions for the time to failure can be analyzed through Weibull plots as shown in Figure 9. Groups of 16 parts were stressed at 6 different voltages, where each group forms a fairly decent Weibull distribution. Through Weibull plots, mean time to failure (MTTF) or time to failure at certain failure rate such as 1ppm can be estimated. Obviously time to failure at high voltages takes much less time compared to that at low voltages. Per VDE0884-11, the smallest to the largest MTTF need to span at least two orders of magnitude and at the lowest test voltage, the 63% time to failure needs to be longer than 10^7 seconds or about 116 days. As it can be seen from Figure 9, the data sets generated at these 6 voltages meet these requirements.



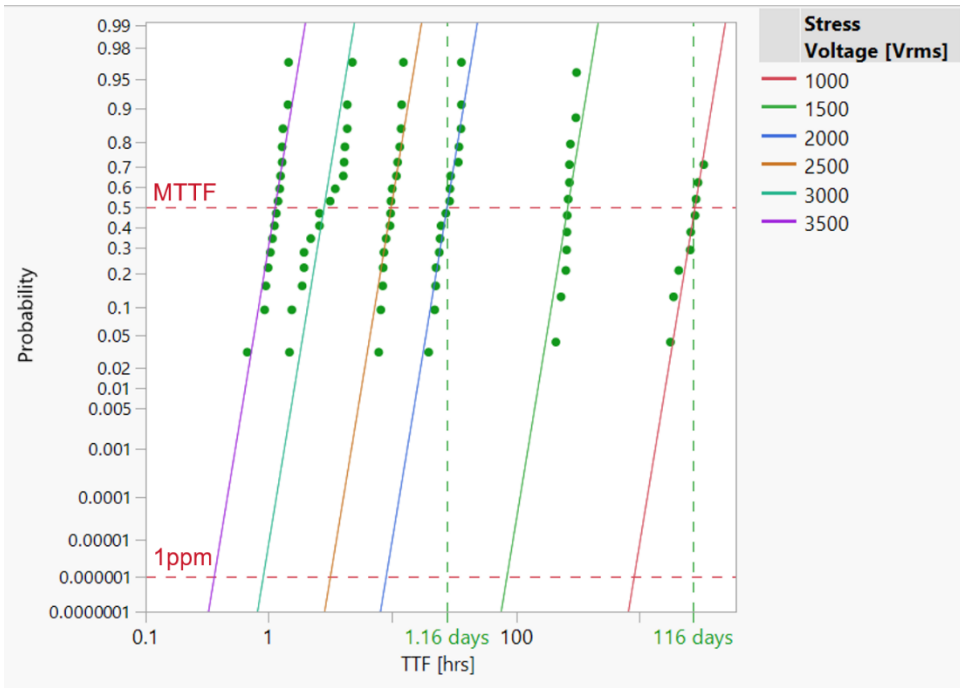

Figure 9. Weibull distribution for isolators with 20 μm thick polyimide

To extrapolate working voltage, time to failure is plotted against stress voltages. For basic insulation, working voltage is determined from the voltage with 20% de-rating where time to failure or lifetime at 1000ppm is greater than 24 years. Similarly for reinforced insulation, working voltage is determined from the voltage with 20% de-rating where lifetime at 1ppm is greater than 30 years.

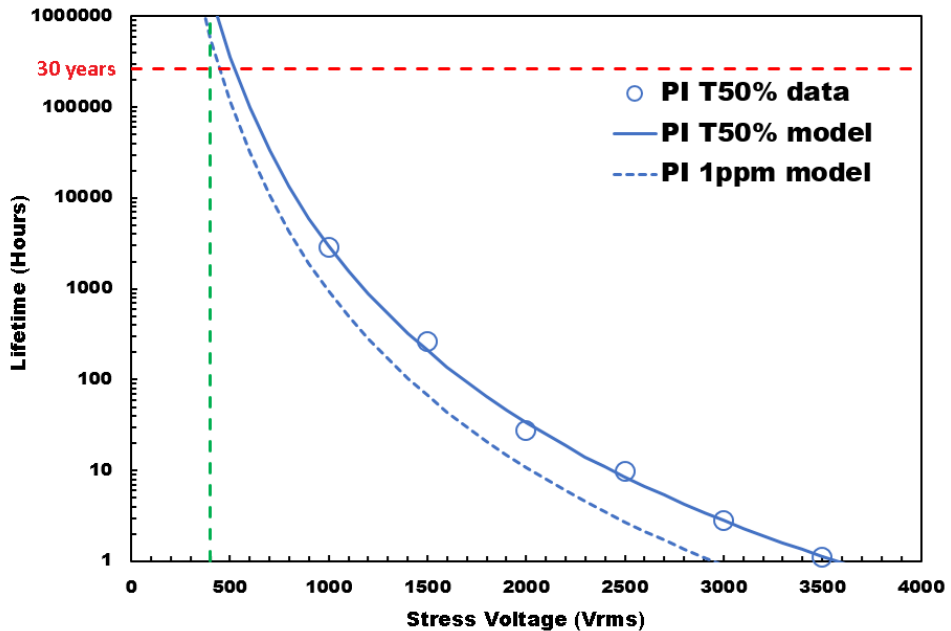

Figure 10. Time to failure plot for isolators with 20 μm thick polyimide



The dominant breakdown mechanism is through charge injections as a result of the direct electron impact from the electrodes to the polyimide surface regions. The breakdown process begins as charges are injected into polyimide surface under HV_{ac} conditions. The charges can become trapped in some local trapping sites at the surface. Once trapped, energy will be released, which will cause local mechanical tension because of stored electrostatic energy. Through quantum activation process, this tension will eventually cause local free volumes, voids or micro-cracks, which act as more local trapping sites. If the HV_{ac} remains long enough, this process will lead to the continued degradation of insulation and eventually electrical punch-through.

Through thermodynamic analysis, the lifetime, L [4], can be expressed as eq. (1),

$$L \sim \frac{e^{-(E-E_t)^n}}{(E - E_t)^m} \tag{1}$$

where E_t is the threshold field where no charge injection will happen, and m, n are scaling constants.

The HV_{ac} endurance data of *i*Coupler devices was analyzed according to the procedure specified by ANSI/IEEE std 930-1987, the “IEEE Guide for the Statistical Analysis of Electrical Insulation Voltage Endurance Data”, and it is observed to follow,

$$L \sim e^{V^{-n}} \tag{2}$$

This phenomenological fit as shown in eq. (2) was used to get worst-case lifetime because it assumes no threshold field as specified by the thermodynamic model. The duration of the HV test becomes prohibitively long if we try to measure the threshold field. Eq. (2) was used to model the time to failure for Figure 10. As you can see, the model fits the data rather well.

We also observed that the lifetime of *i*Coupler devices under DC or unipolar AC is much longer compared to that under bipolar AC; it is at least two orders of magnitude higher. For unipolar waveforms, the trapped charges tend to form an internal field barrier region (i.e. homocharge) around the electrodes that prevents further injection of charge into the polyimide as shown in Figure 11. With a bipolar AC waveform, the reverse of field will prevent formation of this steady field barrier, and the trapped charges will keep progressing into the polyimide and eventually lead to the electrical breakdown. SiO₂, on the other hand, tends to give worse lifetime for DC or unipolar AC, especially for thick films [5].

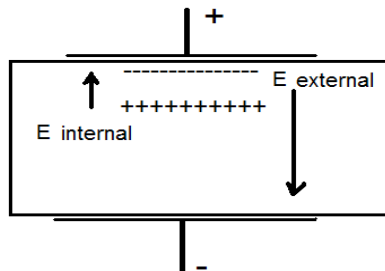

Figure 11. Field barrier region with zero net e-field formed by the trapped charges



The lifetime as shown in Figure 10 is based on worst-case bipolar AC waveforms. HV lifetime is even greater for unipolar AC or DC waveforms. It should be noted that the models described in this chapter relate to polyimide insulation and have no bearing on isolators that use SiO₂ insulators as the primary means for isolation. Likewise, models that predict the HV lifetime of SiO₂-based digital isolators have no bearing on polyimide-based isolation systems.

Figure 12 shows how lifetime for unipolar is compared to that of bipolar for polyimide films. As it can be seen the peak stress voltage for unipolar is about twice that of the peak stress voltage for AC bipolar for the same time to failure. In essence, the lifetime is dependent on peak to peak rather than the peak stress voltage for the polyimide films.

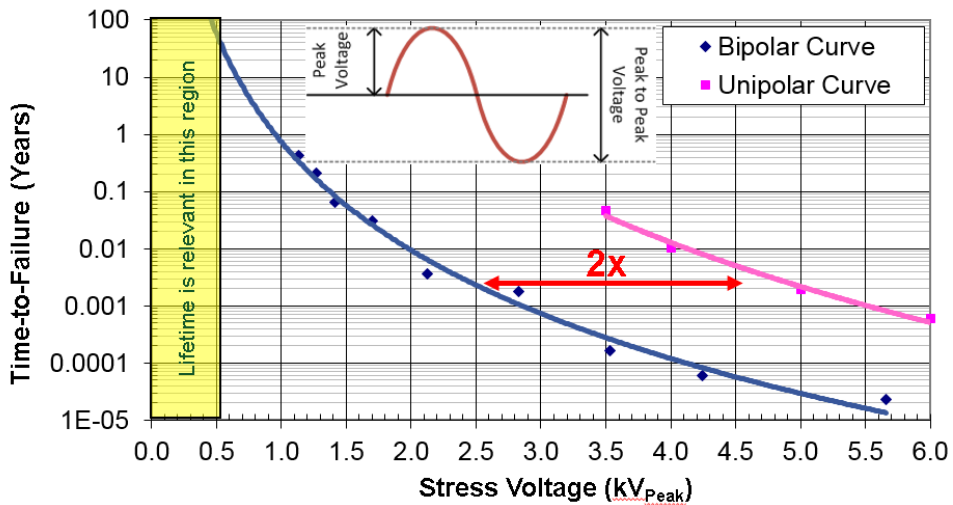

Figure 12. Time to failure comparisons for AC bipolar vs Uni-polar

6. Polyimide Structural Improvements

To improve high voltage endurance for the polyimide, a charge injection barrier can be used as shown in Figure 13 [6, 7]. The charge injection barrier is preferred to be oxide or nitride with large bandgap and high dielectric constant. High dielectric constant will help to reduce the electric field close to the electrode, while the large bandgap raise the energy barrier for charge injection.

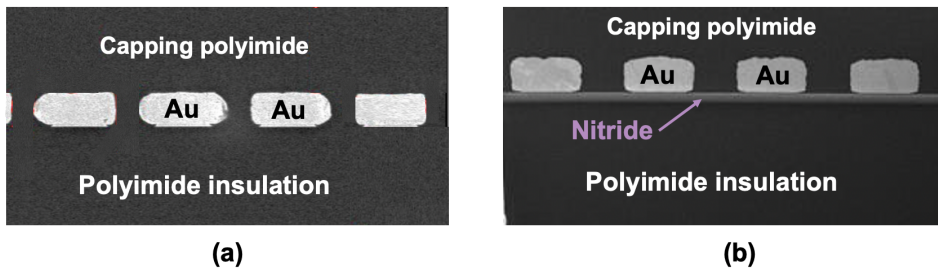

Figure 13. Isolation transformer without (a) and with SiN charge injection barrier (b).

To analyze the charge injection for a given isolation system, a band diagram can be drawn as shown in Figure 14. Four key materials in the isolation system shown in Figure 12 are Au, the top coil material, polyimide, the isolation material between the top coil and bottom coil, oxide, the charge injection barrier and TiW, the seed layer under the Au. Charge injection from Au or TiW into polyimide or oxide, for electrons or holes can be calculated from the band diagram.

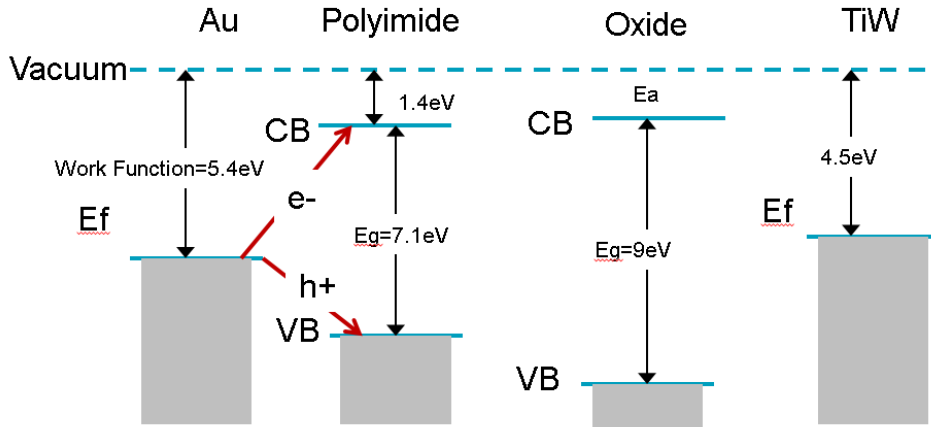

Figure 14. Band diagram for charge injection

Figure 15 presents the charging currents over time for polyimide and polyimide with SiN injection barriers measured under 1000 V. The steady state current when the SiN barrier is introduced is reduced by more than 5 times compared to that of polyimide only. This highlights a significant reduction of the charge injection processes that are well known to be responsible of the electrical aging at high electric field.

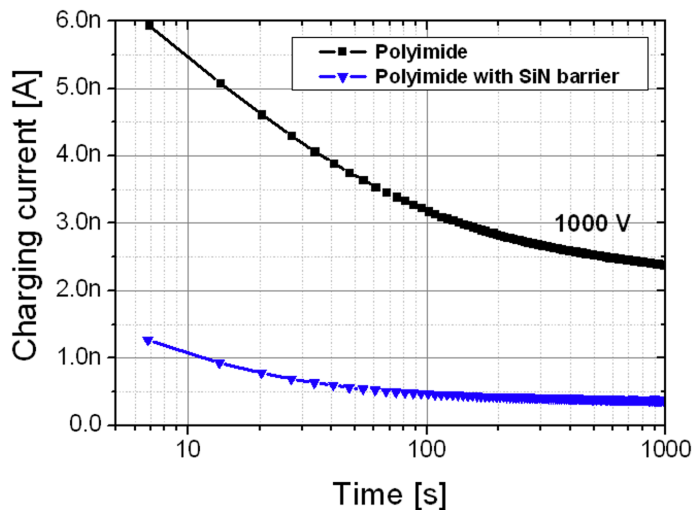

Figure 15. Charging currents comparison for polyimide and polyimide with SiN injection barrier under 1 kV.

Figure 16 presents the time-to-failure (HVE tests) versus AC applied voltage from 1 kV_{rms} up to 3.5 kV_{rms} at 60 Hz for isolators with polyimide and polyimide/SiN barriers single die configurations. The lifetime at 50% and the extrapolation at 1 ppm of the data set are presented. Moreover, for both cases, the extrapolated working voltages at 30-years lifetime are reported. Digital isolator devices with polyimide insulation exhibits a 400 V_{rms} working voltage while the improved design involving SiN injection barriers shows >900 V_{rms} working voltage at 1 ppm (750 V_{rms} after 20% voltage derating). Based on wafer-level analysis comparison, it is reasonable to attribute the lifetime and working voltage improvements to the SiN injection barriers between polyimide and metallic coils. These SiN thin layers, by mitigating bipolar charge injection at the onset of space charge formation, reduce the electrical current, the related thermal effects and, very likely, extend the lifetime for a given voltage.

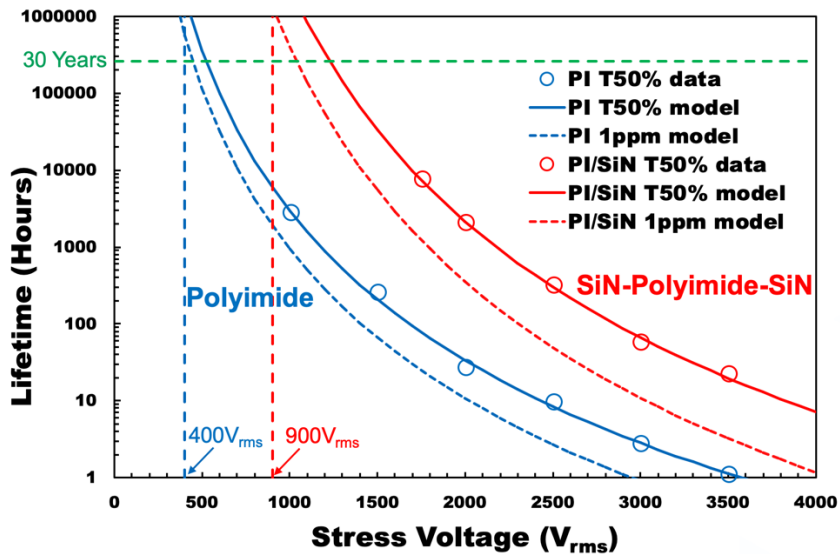

Figure 16. Time-to-failure comparison for polyimide isolators with and without SiN charge injection barrier.

7. Conclusion

Polyimide films have excellent high voltage performance from surge voltage to its high voltage endurance. These films have been characterized and the aging behavior can be further enhanced through a charge injection barrier with large dielectric constant and large bandgap. These polyimide materials are excellent candidates as isolation barrier for digital isolators.

Acknowledgements

The authors would like to thank members of the isolation team at Analog Devices for contribution and the European Union through the Marie Skłodowska-Curie Action (MSCA-IF, H2020 program) for financial funding participation in the frame of the PRISME project (grant N°846455, 2019-2021).



References

- [1] B. Chen, "iCoupler® Products with isoPower™ Technology: Signal and Power Transfer Across Isolation Barrier Using Microtransformers", Technical Paper, www.analog.com, 2006.
- [2] B. Chen, J. Wynne and R. Kliger, "High speed digital isolators using microscale on-chip transformers", *Elektronik Magazine*, 2003.
- [3] Analog Devices, "Surging Across the Barrier: Digital Isolators Set the Standard for Reinforced Insulation", Technical Article MS-2341, www.analog.com, 2012.
- [4] L.A. Dissado, G. Mazzanti, G. Montanari, "The Incorporation of Space Charge Degradation in the Life Model for Electrical Insulating Materials." IEEE Transactions on Dielectrics and Electrical Insulation, Vol. 2, No. 6, pp. 1147-1158, 1995.
- [5] P. Chaparala, J. Suehle. C. Messick, and M. Roush, "Electric Field Dependent Dielectric Breakdown of Intrinsic SiO₂ Films under Dynamic Stress", IEEE 1995 International Integrated Reliability Workshop Final Report, 1995.
- [6] C. McLoughlin, et al, "Isolator and Method of Forming an Isolator", US Patent, No. 9,941,565.
- [7] S. Diahm, L. O'Sullivan, E. Ceccarelli, P. Lambkin, J. O'Malley, J. Fitzgibbon, B. Stenson, P.J. Murphy, Y. Zhao, J. Cornett, A. Sow, B. Chen, S. Geary, "Improving Polyimide Isolation Performance by Tailoring Interfaces with Nitride Layers for Digital Isolator Application, to appear at IEEE ICD Conference Proceedings, 2020.

