



HAL
open science

How to Manage Supports in Incomplete Argumentation

Marie-Christine Lagasquie-Schiex, Jean-Guy Mailly, Antonio Yuste-Ginel

► **To cite this version:**

Marie-Christine Lagasquie-Schiex, Jean-Guy Mailly, Antonio Yuste-Ginel. How to Manage Supports in Incomplete Argumentation. IRIT/RR-2023-04-FR, IRIT : Institut de Recherche en Informatique de Toulouse. 2023. hal-04443886

HAL Id: hal-04443886

<https://ut3-toulouseinp.hal.science/hal-04443886v1>

Submitted on 7 Feb 2024

HAL is a multi-disciplinary open access archive for the deposit and dissemination of scientific research documents, whether they are published or not. The documents may come from teaching and research institutions in France or abroad, or from public or private research centers.

L'archive ouverte pluridisciplinaire **HAL**, est destinée au dépôt et à la diffusion de documents scientifiques de niveau recherche, publiés ou non, émanant des établissements d'enseignement et de recherche français ou étrangers, des laboratoires publics ou privés.

How to Manage Supports in Incomplete Argumentation

M-Christine Lagasquie-Schiex

IRIT, Université de Toulouse, CNRS, Toulouse INP, UT3

Jean-Guy Mailly

Université Paris Cité, LIPADE, F-75006 Paris, France

Antonio Yuste-Ginel

Complutense University of Madrid, Spain

Tech. Report
IRIT/RR- -2023- -04- -FR

November 2023

How to Manage Supports in Incomplete Argumentation

M-Christine Lagasquie-Schiex

Jean-Guy Mailly¹

Antonio Yuste-Ginel²

Abstract

The growing interest in generalizations of Dung's abstract argumentation frameworks has recently led to the simultaneous and independent discovery of a combination of two of these generalizations: Bipolar Argumentation Frameworks (BAFs), where a relation representing supports between arguments is added, and Incomplete Argumentation Frameworks (IAFs), where the existence of arguments and attacks may be uncertain, resulting in the so-called Incomplete Bipolar Abstract Argumentation Frameworks (IBAFs). This paper digs deeper into such a combination by: (i) providing a thoughtful analysis of the existing notions of completion (the hypothetical removal of uncertainty used in IBAFs to reason about argument acceptability); (ii) proposing, motivating and studying new notions of completion; (iii) throwing new complexity results on argument acceptability problems associated with IBAFs; (iv) encoding these reasoning problems into a lightweight version of dynamic logic.

¹The second author benefited from the support of the project AGGREEY ANR-22-CE23-0005 of the French National Research Agency (ANR).

²The third author gratefully acknowledges funding from the project PID2020-117871GB-I00 of the Spanish Ministry of Science and Innovation.

Contents

1	Introduction	1
2	Background	2
2.1	Abstract Argumentation Frameworks without Uncertainty	2
2.2	Bipolar Argumentation Framework without Uncertainty	3
2.3	Incomplete Non-Bipolar Argumentation Frameworks	5
3	Incomplete Bipolar AFs	6
4	Complexity of Reasoning with IBAFs	11
5	Logical Encoding of IBAFs	12
6	Conclusion	17
	References	19
A	Proofs	23
A.1	Proofs for Section 2	23
A.2	Proofs for Section 3	24
A.3	Proofs for Section 4	26
A.4	Proofs for Section 5	30

1 Introduction

Formal argumentation has become a very popular approach to reasoning in Artificial Intelligence in recent decades. This popularity can be rooted in at least two reasons. First, argumentation is an essential component of human reasoning (if not the main one [36]), and therefore it is of crucial importance for human-machine interaction. Second, different ideas from this recently born sub-field have found applications in other, well-established ones (e.g., in multi-agent systems [11]). Within this context, the studies of argument-based models of inference are almost ubiquitously influenced by the Abstract Frameworks (AFs) of Dung [22], where nodes of a graph are used to represent arguments while the edges represent an attack relation among them. This way of approaching argumentation is *abstract*, as one ignores the nature and internal structure of arguments and their interactions in order to focus on more general, dialectical aspects. In this vein, different semantics are used for selecting *extensions* from a given AF, i.e. sets of arguments considered jointly acceptable because they satisfy some intuitive requirements.

Despite their popularity, Dung AFs come equipped with very limited expressivity, which makes them unsuitable to capture more fine-grained argumentative phenomena that do have an impact on argument acceptability. That partially explains the proliferation of very different generalizations of Dung’s model. There are, at least, two important families of such generalisations. First, *the addition of new kinds of interactions among arguments*: among others, *support relations* ([39, 10, 41]), *higher-order frameworks* [6, 12] (where attacks might target other attacks, not only arguments), or *collective interactions* (where the source of attacks might be a set of nodes, instead of a single one [38]). Second, *the addition of uncertainty to the model*, which can be done either by the introduction of *weights and preferences over arguments and interactions* [1, 5, 43], or by taking into account *uncertainty about the presence of the different elements* (both in a qualitative [35] and a probabilistic fashion [30]).

Before going any further, let us illustrate the kind of situations that motivate the development and study of combinations of frameworks from both families:

Example 1 ([32]) *The pension reform wanted by the government is the main topic of a heated discussion between people with the following arguments:*

a_1 : *The pension reform is important and must be implemented.*

a_2 : *Indeed. Because the pension financing system is in deficit (a_2 supports a_1).*

a_3 : *This reform is the only way to avoid a reduction in the amount of pensions (a_3 supports a_1).*

a_4 : *It would be surprising if this reform were the only way to avoid this reduction (a_4 attacks a_3).*

a_5 : *Indeed, an increase in contributions would also prevent a reduction in the amount of pensions (a_5 supports a_4).*

a_6 : *This reform is too premature; there are other reforms in progress and we do not yet know their impact (a_6 attacks a_1).*

Clearly, uncertainty and incompleteness exist in this exchange. First, several politicians consider that the deficit of the pension system is not the real motivation of the government for reforming (so the support from a_2 to a_1 would be uncertain). Second, argument a_4 might not be even taken into consideration by part of the audience (hence its presence is uncertain). Finally, perhaps the impact of the previous reforms on the new one may have already been considered by the government so that the attack from a_6 to a_1 might be disregarded. \square

The intense interest that the mentioned generalizations of AFs illustrated by the previous example have awakened among formal argumentation practitioners is witnessed by the simultaneous, independent definition and computational study of a combination of two such generalizations. In the last few months, our technical report [32] and the ECAI paper [27] by Fazzinga and colleagues came up with the very same definition of *Incomplete Bipolar Argumentation Frameworks* (IBAFs).

This paper moves forward in the combination of argumentative bipolarity and argumentative uncertainty by providing several contributions to the study of IBAFs: (i) we compare in detail the existing notions of completions (the hypothetical removal of uncertainty used in IBAFs to reason about argument acceptability); (ii) we motivate and define a new notion of completion, which is somehow a compromise in between the proposals made by us [32] and Fazzinga et al. [27]; (iii) we throw new complexity results about argument acceptability problems in IBAFs; (iv) we encode these problems in the Dynamic Logic of Propositional Assignments (DL-PA) [3, 2], a well-behaved variant of propositional dynamic logic that has been proven useful to reason about argumentation in recent years [19, 21, 20, 29, 45]. Apart from that, a significant part of the results that will be shown here were already presented in [32], so the current document can be seen as an improved and extended presentation, paper-style, of the mentioned technical report.

The rest of this paper is organized as follows: Sec. 2 gives the background on argumentation; the definition of IBAFs and the different notions of completion are given and discussed in Sec. 3; the complexity results are presented in Sec. 4; and a logical encoding of IBAFs in Sec. 5; Sec. 6 concludes the paper by giving some perspectives. Note that the proofs of our results can be found in Appendix A.

2 Background

2.1 Abstract Argumentation Frameworks without Uncertainty

We suppose the existence of a finite set of arguments \mathbf{A} . An abstract **argumentation framework** (AF) is a pair $\mathcal{F} = \langle \mathcal{A}, \mathcal{R} \rangle$ with $\mathcal{A} \subseteq \mathbf{A}$ the set of **arguments** and $\mathcal{R} \subseteq \mathcal{A} \times \mathcal{A}$ the set of **attacks**. For $a, b \in \mathcal{A}$, we say that a **attacks** b if $(a, b) \in \mathcal{R}$ (and we sometimes use the infix notation $a\mathcal{R}b$). If b attacks some $c \in \mathcal{A}$, then a **defends** c against b . Simi-

larly, a set $S \subseteq \mathcal{A}$ attacks (resp. defends) an argument b if there is some $a \in S$ that attacks b (resp. if, for any $a \mathcal{R} b$, there is $c \in S$ that defends b against a). Let us consider Ex. 1 without taking into account the potential uncertainty, arguments a_4 and a_3 and their relationship can be represented by the graph (the simple plain arrow represents the attack from a_4 to a_3):

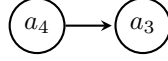

We classically use the concept of **extensions**, proposed by Dung [22], for evaluating the acceptability of arguments, i.e. sets of collectively acceptable arguments. The usual semantics are based on two main principles: conflict-freeness and admissibility. Given $\mathcal{F} = \langle \mathcal{A}, \mathcal{R} \rangle$ an AF, the set $E \subseteq \mathcal{A}$ is **conflict-free** iff $\forall a, b \in E, (a, b) \notin \mathcal{R}$; E is **admissible** iff it is conflict-free and $\forall a \in E, \forall b \in \mathcal{A}$ s.t. $b \mathcal{R} a, \exists c \in E$ s.t. $c \mathcal{R} b$. We use $\text{cf}(\mathcal{F})$ (respectively $\text{ad}(\mathcal{F})$) to denote the set of conflict-free (resp. admissible) sets of an AF \mathcal{F} . We focus on the four semantics proposed by Dung. Formally, the admissible set $E \subseteq \mathcal{A}$ is: a **complete** extension iff E contains all the arguments that it defends; a **preferred** extension iff E is a \subseteq -maximal admissible set; a **grounded** extension iff E is a \subseteq -minimal complete extension; and a **stable extension** iff $E \in \text{cf}(\mathcal{F})$ and $\forall a \in \mathcal{A} \setminus E, E$ attacks a . We use $\text{co}(\mathcal{F}), \text{pr}(\mathcal{F}), \text{gr}(\mathcal{F})$ and $\text{st}(\mathcal{F})$ for the sets of (resp.) complete, preferred, grounded and stable extensions of \mathcal{F} (see more details in [22, 4]).

2.2 Bipolar Argumentation Framework without Uncertainty

This notion has been initially defined as a general approach taking into account two kinds of interactions between arguments: a negative one (attacks) and a positive one (supports), see [13].

A **Bipolar Argumentation Framework** (BAF) is a tuple $\mathcal{B} = \langle \mathcal{A}, \mathcal{R}, \mathcal{S} \rangle$ where $\mathcal{A} \subseteq \mathbf{A}$ are arguments, $\mathcal{R} \subseteq \mathcal{A} \times \mathcal{A}$ is an attack relation, and $\mathcal{S} \subseteq \mathcal{A} \times \mathcal{A}$ is a **support relation** (when $a \mathcal{S} b$ we say that a supports b). Given a (support) relation \mathcal{S} , we use \mathcal{S}^+ to denote its transitive closure (i.e. the smallest (w.r.t. \subseteq) transitive relation containing \mathcal{S}). Let us consider Ex. 1, arguments a_4, a_3 and a_1 and their relationship (ignoring uncertainty) can be represented by the graph (the double plain arrow represents the support from a_3 to a_1):

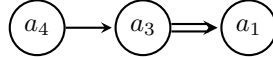

In the general approach to BAFs, semantics are defined using the addition of new attacks. Nevertheless, it turned out that such a general approach is not sufficient for encoding some real cases and sometimes the drawback is the lack of guidelines for choosing the appropriate definitions and semantics depending on the application. Consequently, various kinds of support relations have been defined in the literature as specializations of this general framework. Among others, one could mention the notion of necessary support [39], deductive support [10], evidential support [41], backing support [15], and monotonic support

[28]. Here, we just focus on the two former notions, which have the following intuitive meaning: if a necessarily (resp. deductively) supports b then the acceptance of a is necessary for (resp. implies) the acceptance of b . Moreover, a duality exists between these two approaches: a necessarily supports b iff b deductively supports a (see [14]); so a deductive BAF is a necessary BAF in which the direction of the support arrows has been reversed (and vice-versa).

When the type of support is chosen, the reasoning is made once again with the notion of extension via the addition of new attacks. We focus on the deductive interpretation, as the necessary one follows from the mentioned duality by simply reversing support arrows. Let $\mathcal{B} = \langle \mathcal{A}, \mathcal{R}, \mathcal{S} \rangle$ be a BAF, let $a, b \in \mathcal{A}$, a **attacks** b **according to the deductive interpretation** iff either $a\mathcal{R}b$ (*Case 0: an existing direct attack*), or there is $c \in \mathcal{A}$ s.t. $a\mathcal{R}c$ and $b\mathcal{S}^+c$ (*Case 1: a new attack*), or there is $c \in \mathcal{A}$ s.t. $c\mathcal{R}b$ and $a\mathcal{S}^+c$ (*Case 2: a new attack*). The following figure illustrates cases 1 and 2:³

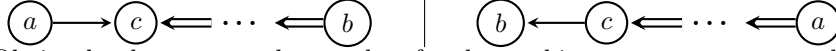

Obviously, the new attacks can therefore be used in turn to create new other attacks through a saturation process. Let **ded** and **nec** stand for ‘deductive’ and ‘necessary’, and let $t \in \{\text{ded}, \text{nec}\}$, we denote by \mathcal{R}^t the set of attacks according to the interpretation t . Then the notions of conflict-freeness and acceptability in a BAF $\mathcal{B} = \langle \mathcal{A}, \mathcal{R}, \mathcal{S} \rangle$ under the interpretation t are defined using the classical argumentation framework $\langle \mathcal{A}, \mathcal{R}^t \rangle$ in which the support relation does not exist. So, given $\mathcal{B} = \langle \mathcal{A}, \mathcal{R}, \mathcal{S} \rangle$ a BAF, $\sigma^t(\mathcal{B}) = \sigma(\langle \mathcal{A}, \mathcal{R}^t \rangle)$ **is the set of extensions of the BAF under the interpretation t and for the semantics σ** ($\sigma \in \{\text{co}, \text{gr}, \text{pr}, \text{st}\}$). We say that $a \in \mathcal{A}$ is **credulously accepted** w.r.t. σ and t if it belongs to some extension in $\sigma^t(\mathcal{B})$, and **sceptically accepted** if it belongs to each extension.

In conclusion, the computation of the semantics for BAFs is done in 3 steps: initially, the BAF is completed by the introduction of the new attacks due to the supports (depending on the meaning of these supports); secondly, the BAF produces an AF by removing the supports; third, the extensions of the original BAF are exactly the Dung extensions on this AF.

Example 2 *The following figure gives, on the left, a possible representation of the discussion described in Ex. 1 considering a deductive meaning for the support and ignoring uncertainty and, on the right, the corresponding classical AF in which the computation of extensions is made:*

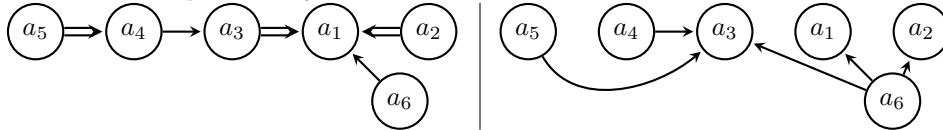

So in this example, if we ignore uncertainty, there is one preferred, grounded, complete and stable extension: $\{a_4, a_5, a_6\}$ (the reform is not the only way to avoid a reduction of the amount of pension; an increase in contributions is another way; the reform is too premature). Note that the existence of supports has

³Case 1 (resp. 2) is also called “super-mediated” (resp. “supported”) attack in the literature.

a real impact on the acceptability of arguments. Consider for instance argument a_2 that is not directly attacked in the BAF. Since it deductively supports an argument that cannot be accepted, then a_2 cannot be accepted either. \square

It is worth noticing that other semantics exist for deductive (resp. necessary) BAFs, using some additional conditions for defining admissibility. One of them is the closure of the support defined as follows (see [13, 27]):⁴ a set of arguments E is **closed for the deductive (resp. necessary) support relation** \mathcal{S} iff $\nexists a \in \mathcal{A} \setminus E$ s. t. E “supports” (resp. “is supported by”) a , with the following definitions: E supports (resp. is supported by) $a \Leftrightarrow \exists b \in E$ s. t. $(b, a) \in \mathcal{S}^+$ (resp. $(a, b) \in \mathcal{S}^+$). The σ -extensions (where $\sigma \in \{\text{gr}, \text{co}, \text{pr}, \text{st}\}$) that are also closed for \mathcal{S} are called the **c- σ -extensions** and the set of all these extensions is denoted by $\sigma_c^t(\mathcal{B})$, for $t \in \{\text{ded}, \text{nec}\}$. Nevertheless, it is easy to prove that c- σ -extensions correspond exactly to σ -extensions (the next result is a rewriting of some of the principles described in [44]):

Proposition 1 *Let $\mathcal{B} = \langle \mathcal{A}, \mathcal{R}, \mathcal{S} \rangle$ be a BAF, $t \in \{\text{ded}, \text{nec}\}$ be the interpretation of the support, and $\sigma \in \{\text{co}, \text{gr}, \text{pr}, \text{st}\}$ be a semantics. Then $\sigma_c^t(\mathcal{B}) = \sigma^t(\mathcal{B})$.*

Note that this result holds for the four studied semantics (complete, grounded, preferred and stable), but not for admissible sets. See for instance the very simple BAF: only 2 arguments a and b and the deductive support (a, b) ; in this case, the set $\{a\}$ is admissible (since the AF corresponding to the initial BAF contains only a and b without any attack) but not c-admissible (since b does not belong to $\{a\}$ whereas it is supported by a).

From a computational point of view, classical decision problems for BAFs under the necessary and deductive interpretations of support have the same complexity as their counterpart for standard AFs, since they can be solved by (polynomially) translating the BAF $\langle \mathcal{A}, \mathcal{R}, \mathcal{S} \rangle$ into the AF $\langle \mathcal{A}, \mathcal{R}^t \rangle$ (see [18, 31, 24]).

2.3 Incomplete Non-Bipolar Argumentation Frameworks

They are AFs with qualitative uncertainty about the presence of some arguments or attacks [17, 8, 7, 35]. Formally, an **Incomplete Argumentation Framework** (IAF) is a tuple $\mathcal{I} = \langle \mathcal{A}, \mathcal{A}^?, \mathcal{R}, \mathcal{R}^? \rangle$ where: $\mathcal{A} \subseteq \mathbf{A}$ is the set of **certain arguments**; $\mathcal{A}^? \subseteq \mathbf{A}$ is the set of **uncertain arguments**; $\mathcal{R} \subseteq (\mathcal{A} \cup \mathcal{A}^?) \times (\mathcal{A} \cup \mathcal{A}^?)$ the set of **certain attacks**; and $\mathcal{R}^? \subseteq (\mathcal{A} \cup \mathcal{A}^?) \times (\mathcal{A} \cup \mathcal{A}^?)$ the set of **uncertain attacks**. \mathcal{A} and $\mathcal{A}^?$ are disjoint sets of arguments, and \mathcal{R} , $\mathcal{R}^?$ are disjoint sets of attacks. Intuitively, \mathcal{A} and \mathcal{R} correspond, respectively, to arguments and attacks that certainly exist, while $\mathcal{A}^?$ and $\mathcal{R}^?$ are those that may (or may not) exist. In a multi-agent, adversarial perspective, \mathcal{A} and \mathcal{R} can be understood as the arguments and attacks that an agent knows her opponent

⁴These conditions have been first introduced in a very general approach by [13] then reused in the deductive case by [27]. Nevertheless, due to the duality between deductive and necessary supports, they can be trivially extended to the necessary case.

is aware of; while $\mathcal{A}^?$ and $\mathcal{R}^?$ are the arguments and attacks such that the agent does not know whether her opponent entertains. Note that a certain attack can exist between two uncertain arguments s (these are usually called *conditionally certain* attacks); that means that, if the agent is *aware of these arguments*, then the attack is certain. Reasoning about IAFs is usually made through the notion of completion, i.e. a classical AF that represents a “possible world” w.r.t. the uncertain information encoded in the IAF. Formally, given $\mathcal{I} = \langle \mathcal{A}, \mathcal{A}^?, \mathcal{R}, \mathcal{R}^? \rangle$ an IAF, a **completion** of \mathcal{I} is an AF $\langle \mathcal{A}_c, \mathcal{R}_c \rangle$ s.t. $\mathcal{A} \subseteq \mathcal{A}_c \subseteq \mathcal{A} \cup \mathcal{A}^?$ and $\mathcal{R} \cap (\mathcal{A}_c \times \mathcal{A}_c) \subseteq \mathcal{R}_c \subseteq (\mathcal{R} \cup \mathcal{R}^?) \cap (\mathcal{A}_c \times \mathcal{A}_c)$.

Reasoning tasks like credulous (or sceptical) acceptance or verification are defined over completions [8, 7, 35]. Hence, each classical task has two variants: the possible view (the property holds in some completion) and the necessary view⁵ (the property holds in each completion). These reasoning tasks are, in most cases, computationally harder than their counterpart for standard AFs (under the usual assumption that the polynomial hierarchy does not collapse) [8, 7]. This can be explained by the exponential number of completions. For instance, the acceptance problems for the grounded semantics are NP or coNP-complete in the case of IAFs whereas it is P-complete for AFs (see [7, 35] for more details).

3 Incomplete Bipolar AFs

Incomplete Bipolar Argumentation Frameworks, which generalize both BAFs and IAFs were defined and studied independently by [27] and [32]. We recall their definition:

Definition 1 (Incomplete Bipolar AF - IBAF) *An Incomplete Bipolar Argumentation Framework (IBAF) is a tuple $\mathcal{IB} = \langle \mathcal{A}, \mathcal{A}^?, \mathcal{R}, \mathcal{R}^?, \mathcal{S}, \mathcal{S}^? \rangle$, where $\mathcal{A}, \mathcal{A}^?$ are disjoint sets of arguments and $\mathcal{R}, \mathcal{R}^?, \mathcal{S}, \mathcal{S}^?$ are disjoint relations between arguments. Elements of \mathcal{S} (resp. $\mathcal{S}^?$) represent certain (resp. uncertain) supports.⁶*

Example 3 *The following figure gives a possible representation of the debate described in Ex. 1, where supports are interpreted deductively, and where there is uncertainty of some elements (represented through dashed lines):*

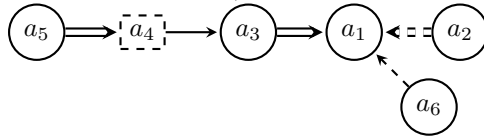

□

⁵We are aware that we use the word “necessary” with two different meanings. We choose not to deviate from the standard terminology in the literature. However it will be clear from the context if we mean “necessary support” or “necessary in all the completions”.

⁶Note that this constraint could be relaxed by permitting $\mathcal{R}^?$ and $\mathcal{S}^?$ to have a (possibly) non-empty intersection. It will be the subject of future work.

Before proposing different formal definitions for the notion of completions of an IBAF, let us informally present them together with their rationale. The key difference among these options is how they deal with certain supports that involve uncertain arguments, e.g., the deductive support from a_5 to a_4 in Ex. 3.

The simplest approach, concurrently proposed by [27] and [32], extends the notion of completion from IAFs by saying that each uncertain element can be present or not in each completion. We call this approach *plain* (or *pla*, for short) completions. In this case, the acceptance of a_5 implies the acceptance of a_4 *whenever a_4 is in the current completion*; this is what might be called a *conditionally certain support*. We believe that plain completions match well with a notion of completion that is independent of the interpretation of support.

A second possible approach, presented in [32] and that we call here *semantic completions*, is to consider that the meaning of support implies a semantic constraint that should be satisfied in any completion. In short, this constraint says that acceptance and support imply presence (in a completion). Following our running example, a completion in which a_5 would be accepted and not a_4 should be ruled out under this view. In more detail, and focusing on deductive supports, the principle we are after says: if a support is certain and its source is accepted then its target must also be accepted, so it must be present in the completion even if it is uncertain.⁷ Thus this second approach proposes to consider *unconditionally certain support (modulo argument acceptance)*, giving, therefore, some kind of “priority” to the notion of support over uncertainty whenever the source is accepted. We believe that this notion of completion captures the meaning of support together with its semantic impact.

A third approach, that has not been studied before, can be seen as a compromise between the previous two notions. The principle governing this approach simply states that if the source of a certain support belongs to a completion, then its target must also belong to this completion. The resulting notion is called *closed completions*. This approach also considers *unconditionally certain supports*, but it is simpler than the second one since the constraint is only syntactical. Moreover, it induces the same effect in terms of semantics: if the source of a certain support is accepted, then its target is also accepted whatever is the closed completion (since any extension is also closed for the support in a BAF). At the same time, it is also more specific and produces fewer completions (because the proposed principle is logically stronger). Thus this notion of completion is also dependent on the meaning of the support relation, but it follows a syntactical perspective. The following definition formally captures all the previous discussion:

Definition 2 (IBAF Completions and extensions) *Let $\mathcal{IB} = \langle \mathcal{A}, \mathcal{A}^?, \mathcal{R}, \mathcal{R}^?, \mathcal{S}, \mathcal{S}^? \rangle$ be an IBAF and σ be a semantics. A BAF $\mathcal{B} = \langle \mathcal{A}_c, \mathcal{R}_c, \mathcal{S}_c \rangle$ is:*

1. a *pla*-completion of \mathcal{IB} (plain completion) *iff* $\mathcal{A} \subseteq \mathcal{A}_c \subseteq \mathcal{A} \cup \mathcal{A}^?, \mathcal{R} \cap (\mathcal{A}_c \times \mathcal{A}_c) \subseteq \mathcal{R}_c \subseteq (\mathcal{R} \cup \mathcal{R}^?) \cap (\mathcal{A}_c \times \mathcal{A}_c), \mathcal{S} \cap (\mathcal{A}_c \times \mathcal{A}_c) \subseteq \mathcal{S}_c \subseteq (\mathcal{S} \cup \mathcal{S}^?) \cap (\mathcal{A}_c \times \mathcal{A}_c)$;

⁷This principle can be straightforwardly adapted to necessary support by the mentioned duality.

2. a \mathbf{t} -completion of \mathcal{IB} w.r.t. the semantics σ with $\mathbf{t} \in \{\mathbf{nec}, \mathbf{ded}\}$ (semantic completion) iff \mathcal{B} is a plain completion and $\forall(a, b) \in \mathcal{S}, \forall E \in \sigma^{\mathbf{t}}(\mathcal{B})$: (i) if $\mathbf{t} = \mathbf{nec}$ and $b \in E$, then $a \in E$ and (ii) if $\mathbf{t} = \mathbf{ded}$ and $a \in E$, then $b \in E$;
3. a \mathbf{t} -completion of \mathcal{IB} with $\mathbf{t} \in \{\mathbf{cded}, \mathbf{cnec}\}$ (closed completion) iff \mathcal{B} is a plain completion and $\forall(a, b) \in \mathcal{S}$: (i) if $\mathbf{t} = \mathbf{cnec}$ and $b \in \mathcal{A}_c$, then $a \in \mathcal{A}_c$ and (ii) if $\mathbf{t} = \mathbf{cded}$ and $a \in \mathcal{A}_c$, then $b \in \mathcal{A}_c$.

For $\mathbf{t} \in \{\mathbf{pla}, \mathbf{nec}, \mathbf{ded}, \mathbf{cded}, \mathbf{cnec}\}$, we denote as $\text{completions}_{\sigma}^{\mathbf{t}}(\mathcal{IB})$ the set of all \mathbf{t} -completions of \mathcal{IB} and the semantics σ ; if σ is not used in the definition of this type of completion, the notation can be simplified as $\text{completions}^{\mathbf{t}}(\mathcal{IB})$ (see items 1 and 3 in Def. 2). The notation $\text{completions}_{\sigma}^{\text{ct}}(\mathcal{IB})$ with $\mathbf{t} \in \{\mathbf{ded}, \mathbf{nec}\}$ can also be used in place of $\text{completions}_{\sigma}^{\mathbf{t}}(\mathcal{IB})$ whenever $\mathbf{t} \in \{\mathbf{cded}, \mathbf{cnec}\}$.

We denote as $\sigma^{\mathbf{t}_2}\text{-}\mathbf{t}_1(\mathcal{IB})$ the set of all extensions of \mathcal{IB} under the \mathbf{t}_2 interpretation of the support ($\mathbf{t}_2 \in \{\mathbf{nec}, \mathbf{ded}\}$), the semantics σ ($\sigma \in \{\mathbf{pr}, \mathbf{gr}, \mathbf{co}, \mathbf{st}\}$) and the \mathbf{t}_1 type of the completions ($\mathbf{t}_1 \in \{\mathbf{pla}, \mathbf{nec}, \mathbf{ded}, \mathbf{cnec}, \mathbf{cded}\}$). So $\sigma^{\mathbf{t}_2}\text{-}\mathbf{t}_1(\mathcal{IB}) = \{E \subseteq \mathcal{A} \cup \mathcal{A}^? \mid \exists \mathcal{B} \in \text{completions}_{\sigma}^{\mathbf{t}_1}(\mathcal{IB}) \text{ and } E \in \sigma^{\mathbf{t}_2}(\mathcal{B})\}$. Some simplified notations can be used: $\sigma^{\mathbf{t}}(\mathcal{IB})$ if $\mathbf{t} = \mathbf{t}_1 = \mathbf{t}_2 \in \{\mathbf{ded}, \mathbf{nec}\}$; $\sigma^{\text{ct}}(\mathcal{IB})$ if $\mathbf{t} = \mathbf{t}_2$ and $\mathbf{t}_1 = \text{ct}_2$. Each element of $\sigma^{\mathbf{t}_2}\text{-}\mathbf{t}_1(\mathcal{IB})$ is called a $\sigma^{\mathbf{t}_2}\text{-}\mathbf{t}_1$ -extension.

In Def. 2, Item 1 represents the basic syntactical impact of uncertainty (an uncertain element is present or not in each completion), whereas the other items specify the impact of certain supports. Note that the last two items emphasize the closure of the *certain part* of the support relation assuming that *these certain supports must be kept* in the completions either through the semantics (Item 2), or by a syntactical constraint (Item 3).

It is worth remarking that **pla**-completions correspond exactly to the completions defined in [27]. Moreover, there exists a strong relationship between \mathbf{t} -completions (and ct -completions) with $\mathbf{t} \in \{\mathbf{nec}, \mathbf{ded}\}$ and the recently proposed *constrained IAFs* [33, 29], and *IAFs with dependencies* [25, 26]. In these works, a (set of) propositional formula(s) is added to an IAF in order to express constraints about the completions. These constraints could be used to filter among the completions of an IBAF for obtaining the set $\text{completions}^{\text{ct}}(\mathcal{IB})$. However, the constraints or dependencies in these related works only take into account syntactical information. So they are closer to ct -completions than to \mathbf{t} -completions defined using semantics. Notice moreover that these related works only consider attack relations, so we would need to enrich their propositional language to take into account (uncertain) supports.

Example 4 Using Def. 2, the IBAF from Ex. 1 has 8 **pla**-completions (see Fig. 1). Moreover, with the **pr** semantics, only 4 **ded**-completions can be built: \mathcal{B}_3 , \mathcal{B}_4 , \mathcal{B}_7 and \mathcal{B}_8 that are also the only **cded**-completions whatever is the chosen semantics.

- for \mathcal{B}_3 (resp. \mathcal{B}_7), there is one preferred extension $\{a_1, a_2, a_4, a_5, a_6\}$; note that an additional attack from a_5 to a_3 is introduced for taking into account the deductive meaning of the support;

- for \mathcal{B}_4 , there is one preferred extension $\{a_2, a_4, a_5, a_6\}$; note that two additional attacks are introduced: (a_5, a_3) and (a_6, a_3) ;
- for \mathcal{B}_8 , there is one preferred extension $\{a_4, a_5, a_6\}$; note that 3 additional attacks exist: (a_5, a_3) , (a_6, a_3) and (a_6, a_2) .

For the other \mathcal{B}_i , a_5 belongs to the preferred extension whereas a_4 does not since a_4 is not in the completion, so they are not ded-completions.

So $\text{pr}^{\text{ded}}(\mathcal{IB}) = \text{pr}^{\text{cded}}(\mathcal{IB}) = \{\{a_1, a_2, a_4, a_5, a_6\}, \{a_2, a_4, a_5, a_6\}, \{a_4, a_5, a_6\}\}$, and $\text{pr}^{\text{ded-pla}}(\mathcal{IB}) = \{\{a_1, a_2, a_4, a_5, a_6\}, \{a_2, a_4, a_5, a_6\}, \{a_4, a_5, a_6\}, \{a_1, a_2, a_3, a_5, a_6\}, \{a_2, a_5, a_6\}, \{a_5, a_6\}\}$. \square

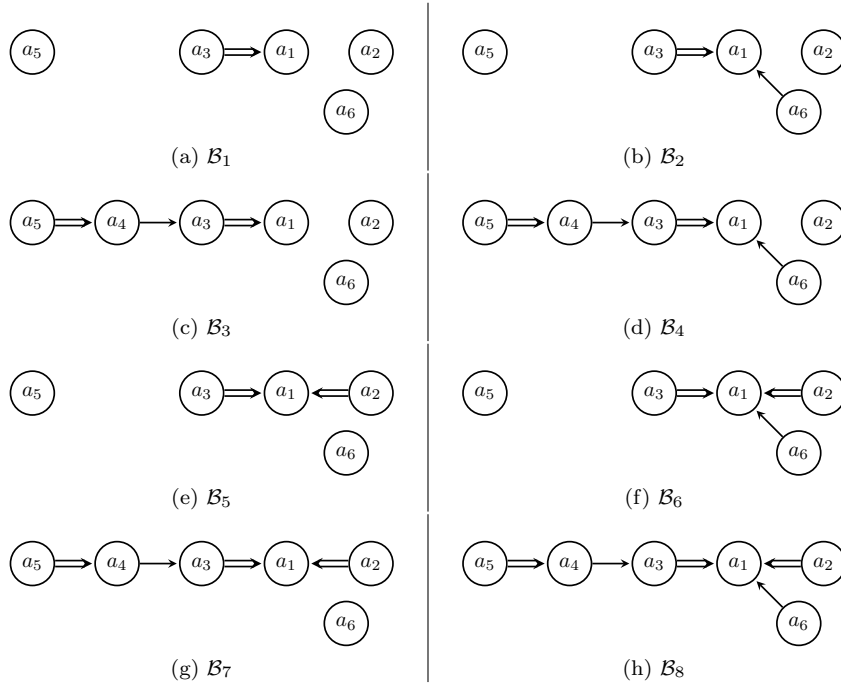

Figure 1: The completions of \mathcal{IB} from Ex. 1

Interestingly, the notion of “unconditional certainty” is useless when considering attacks. Indeed if an attack from a to b is certain whereas a or b are not, then only two kinds of completion exist: some completions contain a , b and the attack and so a and b cannot be accepted together; some others in which a or b are missing, so the attack too, and a and b cannot be accepted together; thus in each case, the meaning of the attack is captured by purely syntactical means.

Comparison of the Three Approaches. Let us first consider the trivial case: there is no uncertainty. In this case, there is only one completion and the following proposition holds showing that the three approaches collapse:

Proposition 2 *Let \mathcal{IB} be an IBAF, let \mathfrak{t} be an interpretation for supports ($\mathfrak{t} \in \{\text{ded}, \text{nec}\}$), and let $\sigma \in \{\text{pr}, \text{gr}, \text{co}, \text{st}\}$ be a semantics. We have that if $\mathcal{A}^\sigma = \mathcal{R}^\sigma = \mathcal{S}^\sigma = \emptyset$, then $\sigma^{\mathfrak{t}\text{-pla}}(\mathcal{IB}) = \sigma^{\mathfrak{t}}(\mathcal{IB}) = \sigma^{\text{ct}}(\mathcal{IB}) = \sigma(\langle \mathcal{A}, \mathcal{R}^{\mathfrak{t}} \rangle)$.*

In the general case, a relationship exists between the three approaches:

Proposition 3 *Let \mathcal{IB} be an IBAF, let \mathfrak{t} be an interpretation for supports ($\mathfrak{t} \in \{\text{ded}, \text{nec}\}$), and let $\sigma \in \{\text{pr}, \text{gr}, \text{co}, \text{st}\}$ be a semantics. We have that:*

- $\text{completions}^{\text{ct}}(\mathcal{IB}) \subseteq \text{completions}_\sigma^{\mathfrak{t}}(\mathcal{IB}) \subseteq \text{completions}^{\text{pla}}(\mathcal{IB})$. *The reverse does not hold in general.*
- $\sigma^{\text{ct}}(\mathcal{IB}) \subseteq \sigma^{\mathfrak{t}}(\mathcal{IB}) \subseteq \sigma^{\mathfrak{t}\text{-pla}}(\mathcal{IB})$. *The reverse does not hold in general.*

\mathcal{B}_1 in Ex. 4 is an example of a pla -completion that is not a ded -completion (whatever is the chosen semantics). An example of a ded -completion for a given semantics that is not a cded -completion can be obtained as follows: let consider a certain support (a, b) and a completion \mathcal{B} such that (i) $a \in \mathcal{B}$, $b \notin \mathcal{B}$ and (ii) a is never accepted in \mathcal{B} for this semantics.

Comparison with the Approach of [27]. First of all, let us recall that the interpretation of supports considered in [27] is only the deductive one. Moreover, Fazzinga et al. propose to transform the initial BAF into two types of AF: either a so-called **d-IBAF** obtained by the addition of three kinds of attacks (corresponding exactly to our cases 0 to 2, see Sec. 2), or a so-called **s-IBAF** obtained by the addition of only two kinds of attacks (corresponding to our cases 0 and 2). Then, they used three types of semantics, each kind being related to a specific notion of coherence: conflict-freeness (d-semantics), safety (s-semantics), and support-closedness (c-semantics). Thus they define 6 different sets of extensions, called i -extensions (one at each crossing point between the type of AF and the chosen semantics). So a comparison between our work and the work done in [27] makes sense only if we consider the same interpretation of the support relation: the deductive one with the same three additional attacks (our cases 0 to 2). It is interesting to note that, in this interpretation, conflict-freeness and safety are equivalent and thus d-semantics and s-semantics collapse. The following proposition gives the main points of this comparison, showing that both approaches collapse in the basic case (plain completions) but that our approach can also be more selective (semantic or closed completions):

Proposition 4 *Let \mathcal{IB} be an IBAF with a deductive interpretation for the support. Let $\sigma \in \{\text{pr}, \text{gr}, \text{co}, \text{st}\}$ be a semantics. Let $I_\sigma^c(\mathcal{IB})$ (resp. $I_\sigma^d(\mathcal{IB})$) be the set of i -extensions under the c - σ (resp. d - σ) semantics for \mathcal{IB} as defined in [27].*

- $\sigma^{\mathfrak{t}\text{-pla}}(\mathcal{IB}) = I_\sigma^d(\mathcal{IB}) = I_\sigma^c(\mathcal{IB})$.
- $\sigma^{\text{cded}}(\mathcal{IB}) \subseteq \sigma^{\text{ded}}(\mathcal{IB}) \subseteq I_\sigma^c(\mathcal{IB})$. *The reverse does not hold in general.*

Prop. 4 shows a link with the approach defined in [27] when the deductive interpretation is used for the support relation. Nevertheless, our approach is,

at the same time, more general since it also proposes a direct definition for taking into account the “necessary” interpretation and more specific since it emphasizes the role of certain supports.

4 Complexity of Reasoning with IBAFs

Let us investigate the complexity of reasoning with IBAFs. We focus on acceptability problems, i.e. possible credulous acceptability (PCA), necessary credulous acceptability (NCA) and their counterparts for sceptical acceptability (PSA and NSA). Formally, given an IBAF $\mathcal{IB} = \langle \mathcal{A}, \mathcal{A}^?, \mathcal{R}, \mathcal{R}^?, \mathcal{S}, \mathcal{S}^? \rangle$ and $a \in \mathcal{A}$, and given $\mathbf{t}_1 \in \{\text{pla}, \text{nec}, \text{ded}, \text{cnec}, \text{cded}\}$ and $\mathbf{t}_2 \in \{\text{nec}, \text{ded}\}$ s.t. if $\mathbf{t}_1 \in \{\text{nec}, \text{ded}\}$, then $\mathbf{t}_1 = \mathbf{t}_2$ and if $\mathbf{t}_1 \in \{\text{cnec}, \text{cded}\}$, then $\mathbf{t}_1 = \mathbf{ct}_2$,

- $\sigma^{\mathbf{t}_2-\mathbf{t}_1}$ -PCA: $\exists \mathcal{B} \in \text{completions}_{\sigma}^{\mathbf{t}_1}(\mathcal{IB}), \exists E \in \sigma^{\mathbf{t}_2}(\mathcal{B})$ s.t. $a \in E$?
- $\sigma^{\mathbf{t}_2-\mathbf{t}_1}$ -NCA: $\forall \mathcal{B} \in \text{completions}_{\sigma}^{\mathbf{t}_1}(\mathcal{IB}), \exists E \in \sigma^{\mathbf{t}_2}(\mathcal{B})$ s.t. $a \in E$?
- $\sigma^{\mathbf{t}_2-\mathbf{t}_1}$ -PSA: $\exists \mathcal{B} \in \text{completions}_{\sigma}^{\mathbf{t}_1}(\mathcal{IB}), \forall E \in \sigma^{\mathbf{t}_2}(\mathcal{B})$ s.t. $a \in E$?
- $\sigma^{\mathbf{t}_2-\mathbf{t}_1}$ -NSA: $\forall \mathcal{B} \in \text{completions}_{\sigma}^{\mathbf{t}_1}(\mathcal{IB}), \forall E \in \sigma^{\mathbf{t}_2}(\mathcal{B})$ s.t. $a \in E$?

Reasoning with Plain Completions. For the case of $\mathbf{t}_1 = \text{pla}$, the results were recently given for $\sigma \in \{\text{ad}, \text{st}, \text{gr}, \text{co}, \text{pr}\}$ by [27, 32], which both independently show that (for any $\mathbf{t}_2 \in \{\text{ded}, \text{nec}\}$) PCA is NP-complete for all these semantics; NCA is coNP-complete for gr and Π_2^{P} -complete for the other semantics; PSA is NP-complete for $\sigma \in \{\text{co}, \text{gr}\}$, Σ_2^{P} -complete for the stable semantics and Σ_3^{P} -complete for the preferred semantics; and finally NSA is coNP-complete for $\sigma \in \{\text{st}, \text{gr}, \text{co}\}$ and Π_2^{P} -complete for pr .⁸ Thus this case is not harder than the case of (non-bipolar) IAFs.

Reasoning with Semantic Completions. Now we focus on semantic completions (conditions 1 and 2 in Def. 2), based on $\mathbf{t}_1 \in \{\text{nec}, \text{ded}\}$. We start with showing that the problem “is a given BAF a \mathbf{t}_1 -completion of a given IBAF w.r.t. a given semantics?” is a hard problem (while it is polynomial for the pla case), except for the grounded semantics.

Proposition 5 *Let $\mathcal{IB} = \langle \mathcal{A}, \mathcal{A}^?, \mathcal{R}, \mathcal{R}^?, \mathcal{S}, \mathcal{S}^? \rangle$ be an IBAF, and $\mathcal{B}^* = \langle \mathcal{A}^*, \mathcal{R}^*, \mathcal{S}^* \rangle$. Checking whether $\mathcal{B}^* \in \text{completions}_{\sigma}^{\mathbf{t}}(\mathcal{IB})$ (for $\mathbf{t} \in \{\text{nec}, \text{ded}\}$) is in P for $\sigma = \text{gr}$, coNP-complete for $\sigma \in \{\text{ad}, \text{co}, \text{st}\}$ and Π_2^{P} -complete for $\sigma = \text{pr}$.*

Now, we study the complexity of acceptability problems, providing lower bounds and upper bounds for all the problems and semantics considered.

Proposition 6 *For $\mathbf{t} \in \{\text{nec}, \text{ded}\}$ the following complexity results hold:*

⁸As usual, sceptical reasoning is trivial with $\sigma = \text{ad}$ since the empty set is always an admissible set.

- For $\sigma \in \{\text{ad}, \text{st}, \text{co}, \text{pr}\}$, σ^t -t-PCA is NP-hard and in Σ_2^P , and NP-complete for $\sigma = \text{gr}$.
- For $\sigma \in \{\text{st}, \text{co}\}$, σ^t -t-NSA is coNP-hard and in Π_2^P , it is trivial for $\sigma = \text{ad}$, it is coNP-complete for $\sigma = \text{gr}$, and it is Π_2^P -hard and in Π_3^P for $\sigma = \text{pr}$.
- For $\sigma \in \{\text{ad}, \text{st}, \text{co}\}$, σ^t -t-NCA is Π_2^P -complete, it is coNP-complete for $\sigma = \text{gr}$, and it is Π_2^P -hard and in Π_3^P for $\sigma = \text{pr}$.
- For $\sigma = \text{gr}$, σ^t -t-PSA is NP-complete, it is trivial for $\sigma = \text{ad}$, NP-hard and in Σ_2^P for $\sigma = \text{co}$, it is Σ_2^P -complete for $\sigma = \text{st}$, and Σ_3^P -complete for $\sigma = \text{pr}$.

Reasoning with Closed Completions. Now we consider closed completions (i.e. $\mathbf{t}_1 \in \{\text{cded}, \text{cnec}\}$, see conditions 1 and 3 in Def. 2), with the adequate support relation (i.e. $\mathbf{t}_2 \in \{\text{nec}, \text{ded}\}$, and moreover $\mathbf{t}_2 = \text{nec}$ if $\mathbf{t}_1 = \text{cnec}$, and $\mathbf{t}_2 = \text{ded}$ if $\mathbf{t}_1 = \text{cded}$). As for pla-completions, we show that checking the (various kinds of) acceptability of arguments is in this case not harder than in the case of (non-bipolar) IAFs. This comes from the following observation:

Observation 1 *Let $\mathcal{IB} = \langle \mathcal{A}, \mathcal{A}^?, \mathcal{R}, \mathcal{R}^?, \mathcal{S}, \mathcal{S}^? \rangle$ be an IBAF, and $\mathcal{B}^* = \langle \mathcal{A}^*, \mathcal{R}^*, \mathcal{S}^* \rangle$. Checking whether $\mathcal{B}^* \in \text{completions}^{\text{ct}}(\mathcal{IB})$ (for $\mathbf{t} \in \{\text{ded}, \text{nec}\}$) can be done in polynomial time (w.r.t. the number of arguments $|\mathcal{A} \cup \mathcal{A}^?|$).*

Proposition 7 *For $\mathbf{t} \in \{\text{nec}, \text{ded}\}$ the following complexity results hold:*

- For $\sigma \in \{\text{ad}, \text{gr}, \text{st}, \text{co}, \text{pr}\}$, σ^t -ct-PCA is NP-complete.
- For $\sigma \in \{\text{gr}, \text{st}, \text{co}\}$, σ^t -ct-NSA is coNP-complete, it is trivial for $\sigma = \text{ad}$, and it is Π_2^P -complete for $\sigma = \text{pr}$.
- For $\sigma \in \{\text{ad}, \text{st}, \text{co}, \text{pr}\}$, σ^t -ct-NCA is Π_2^P -complete, and it is coNP-complete for $\sigma = \text{gr}$.
- For $\sigma \in \{\text{co}, \text{gr}\}$, σ^t -ct-PSA is NP-complete, it is trivial for $\sigma = \text{ad}$, it is Σ_2^P -complete for $\sigma = \text{st}$, and Σ_3^P -complete for $\sigma = \text{pr}$.

5 Logical Encoding of IBAFs

We will now encode acceptability problems for IBAFs in DL-PA. For space reasons, we only list here the main definitions and results. For more details, the reader is referred to previous papers on abstract models of argumentation and DL-PA [19, 21, 20, 29, 45, 32].

Syntax of DL-PA. We assume the existence of a denumerable set of propositional variables $\text{Prp} = \{p_1, p_2, \dots\}$. We suppose that Prp contains several kinds of distinguished variables capturing the statuses of arguments and relations between them. First, given a set of arguments $\mathcal{A} \subseteq \mathbf{A}$ we define its set of **awareness variables**, $\text{AW}_{\mathcal{A}} = \{\text{aw}_x \mid x \in \mathcal{A}\}$ (these will be used to talk about the presence of arguments in completions), and its set of **acceptance variables** $\text{IN}_{\mathcal{A}} = \{\text{in}_x \mid x \in \mathcal{A}\}$. Second, given a relation $X \subseteq \mathbf{A} \times \mathbf{A}$ we define its set of **attack variables** $\text{ATT}_X = \{\text{r}_{x,y} \mid (x,y) \in X\}$ and its set of **support variables** $\text{SUP}_X = \{\text{s}_{x,y} \mid (x,y) \in X\}$. Summing up, we assume that $\text{Prp}_{\mathbf{A}} \subseteq \text{Prp}$ where $\text{Prp}_{\mathbf{A}} = \text{AW}_{\mathbf{A}} \cup \text{IN}_{\mathbf{A}} \cup \text{ATT}_{\mathbf{A} \times \mathbf{A}} \cup \text{SUP}_{\mathbf{A} \times \mathbf{A}}$. Note that the inclusion $\text{Prp} \subseteq \text{Prp}_{\mathbf{A}}$ is not assumed. The reason for this is that we will use fresh copies of variables in $\text{Prp}_{\mathbf{A}}$ at some points of the encoding process and hence we need Prp to be larger than $\text{Prp}_{\mathbf{A}}$. Formulas and programs of DL-PA are defined by mutual recursion:

$$\begin{array}{l} \text{For formulas: } \varphi ::= p \mid \neg\varphi \mid (\varphi \wedge \varphi) \mid [\pi]\varphi \quad (p \in \text{Prp}) \\ \text{For programs: } \pi ::= +p \mid -p \mid \varphi? \mid (\pi; \pi') \mid (\pi \cup \pi') \mid \pi^* \quad (p \in \text{Prp}) \end{array}$$

The intended meaning of formulas is as usual for atoms and the Boolean connectors. As for modal formulas, $[\pi]\varphi$ reads “ φ is true after every possible execution of π ”, so that the dual $\langle \pi \rangle \varphi$, defined as $\neg[\pi]\neg\varphi$, reads “there is a possible execution of π that makes φ true”. As for programs, their intended meaning is as follows: $+p$ (resp. $-p$) is the atomic program that makes p true (resp. false). $\varphi?$ is the program that tests whether φ is true. $(\pi; \pi')$ is the sequential composition of π and π' (“first execute π and then π' ”). $(\pi \cup \pi')$ is the non-deterministic choice (“choose non-deterministically between π or π' and execute one of them”). Finally, π^* is the unbounded iteration of π (“execute π a finite number of times”).

Semantics of DL-PA. Given a propositional valuation $v \subseteq \text{Prp}$ (so v is the set of the variables that are true), **truth for formulas** φ and the **meaning of programs** $\|\pi\|$ is given by mutual recursion:

$$\begin{array}{l} v \models p \quad \text{if } p \in v \\ v \models [\pi]\varphi \quad \text{if } (v, v') \in \|\pi\| \text{ implies } v' \models \varphi \end{array}$$

and as usual for the Boolean connectives; moreover, considering that, given a binary relation R , R^* denotes the reflexive and transitive closure of R , the interpretation of programs is:

$$\begin{array}{l} \|\!+p\|\ = \{(v, v') \mid v' = v \cup \{p\}\} \\ \|\varphi?\|\ = \{(v, v) \mid v \models \varphi\} \\ \|\pi \cup \pi'\|\ = \|\pi\| \cup \|\pi'\| \end{array} \quad \begin{array}{l} \|\!-p\|\ = \{(v, v') \mid v' = v \setminus \{p\}\} \\ \|\pi; \pi'\|\ = \|\pi\| \circ \|\pi'\| \\ \|\pi^*\|\ = \|\pi\|^* \end{array}$$

Here are some useful abbreviations in our object language (where $\mathbf{P} = \{p_1, \dots, p_n\}$ is a finite subset of Prp):

$$\begin{array}{l} \text{mkTrueSome}(\mathbf{P}) = \dot{\bigvee}_{p \in \mathbf{P}} (+p \cup \text{skip}) = (+p_1 \cup \text{skip}); \dots; (+p_n \cup \text{skip}) \\ \text{mkFalseAll}(\mathbf{P}) = \dot{\bigvee}_{p \in \mathbf{P}} (-p) = -p_1; \dots; -p_n \\ \text{vary}(\mathbf{P}) = \dot{\bigvee}_{p \in \mathbf{P}} (+p \cup -p) = (+p_1 \cup -p_1); \dots; (+p_n \cup -p_n) \\ \text{if } \varphi \text{ then } \pi \text{ else } \pi' = (\varphi?; \pi) \cup (\neg\varphi?; \pi') \\ \text{while } \varphi \text{ do } \pi = (\varphi?; \pi)^*; \neg\varphi? \end{array}$$

From Valuations to (B)AFs and Backward. From our hypothesis that Prp contains $\text{Prp}_{\mathbf{A}}$, we can define for each valuation v the BAF $\mathcal{B}_v = \langle \mathcal{A}_v, \mathcal{R}_v, \mathcal{S}_v \rangle$ (called the **BAF represented by v**) where: $\mathcal{A}_v = \{x \in \mathbf{A} \mid \text{aw}_x \in v\}$, $\mathcal{R}_v = \{(x, y) \in \mathcal{A}_v \times \mathcal{A}_v \mid \text{r}_{x,y} \in v\}$, and $\mathcal{S}_v = \{(x, y) \in \mathcal{A}_v \times \mathcal{A}_v \mid \text{s}_{x,y} \in v\}$. Note that the definition of \mathcal{R}_v and \mathcal{S}_v guarantees that \mathcal{B}_v is always a well-defined BAF (even if $\text{r}_{x,y} \in v$ but $\text{aw}_x \notin v$ or $\text{aw}_y \notin v$, or the analogous case for supports). The other way round, each BAF $\langle \mathcal{A}, \mathcal{R}, \mathcal{S} \rangle$ is represented by **its associated valuation** $v_{\langle \mathcal{A}, \mathcal{R}, \mathcal{S} \rangle} = \{\text{aw}_x \mid x \in \mathcal{A}\} \cup \{\text{r}_{x,y} \mid (x, y) \in \mathcal{R}\} \cup \{\text{s}_{x,y} \mid (x, y) \in \mathcal{S}\}$. Note that both functions (from valuations to BAFs and backward) can be also defined for AFs, by just ignoring the supports. Finally, for each valuation v we define the **extension associated to v** as the set $\mathbf{E}_v = \{x \in \mathbf{A} \mid \text{in}_x \in v\}$.

Argumentation Semantics in DL-PA. We rely on previous encoding of argumentation semantics in DL-PA (see [45, Theorem 1] for a comprehensive result). The main idea underlying these encodings is to write a generic DL-PA program mkExt^σ parametrised by each semantics σ , s.t. for every AF $\langle \mathcal{A}, \mathcal{R} \rangle$ we have that: $\sigma(\langle \mathcal{A}, \mathcal{R} \rangle) = \{\mathbf{E}_{v'} \mid (v_{\langle \mathcal{A}, \mathcal{R} \rangle}, v') \in \|\text{mkExt}^\sigma\|\}$. Due to space reasons, we only include here the instance of mkExt for capturing stable semantics as an illustration:

$$\begin{array}{l} \text{Well} = \bigwedge_{x \in \mathbf{A}} (\text{in}_x \rightarrow \text{aw}_x) \\ \text{Stable} = \text{Well} \wedge \bigwedge_{x \in \mathbf{A}} \left(\text{aw}_x \rightarrow (\text{in}_x \leftrightarrow \neg \bigvee_{y \in \mathbf{A}} (\text{in}_y \wedge \text{r}_{y,x})) \right) \\ \text{mkExt}^{\text{st}} = \text{vary}(\text{IN}_{\mathbf{A}}); \text{Stable} \end{array}$$

Deductive and Necessary Supports in DL-PA. [32] was the first work capturing ded/nec supports in DL-PA. We sketch here the main ideas, taking deductive supports as the primitive notion and defining necessary ones by duality (the opposite strategy to the one followed in [32]). The first thing is to capture the transitive closure of the support relation associated with a valuation. This program computes one step of such closure:

$$\text{step} = \text{;}_{x,y,z \in \mathbf{A}} \left((\text{aw}_x \wedge \text{aw}_y \wedge \text{aw}_z \wedge \text{s}_{x,y} \wedge \text{s}_{y,z})?; +\text{s}_{x,z} \right)$$

Moreover, the following formula is true in those valuations where \mathcal{S}_v is transitive:

$$\text{Transitive} = \bigwedge_{x,y,z \in \mathbf{A}} \left((\text{aw}_x \wedge \text{aw}_y \wedge \text{aw}_z \wedge \text{s}_{x,y} \wedge \text{s}_{y,z}) \rightarrow \text{s}_{x,z} \right)$$

Hence, the following program computes the transitive closure of \mathcal{S}_v :

$$\text{transClosure} = \text{while } \neg \text{Transitive} \text{ do step}$$

Now, we can capture complex attacks (see their description in Sec. 2):

$$\begin{array}{l} \text{r}_{x,y}^{\text{aw}} = \text{aw}_x \wedge \text{aw}_y \wedge \text{r}_{x,y} \quad (\text{direct attack}) \\ \text{r}_{x,y}^{\text{case1}} = \text{aw}_x \wedge \text{aw}_y \wedge \bigvee_{z \in \mathbf{A}} (\text{aw}_z \wedge \text{r}_{x,z} \wedge [\text{transClosure}] \text{s}_{y,z}) \\ \text{r}_{x,y}^{\text{case2}} = \text{aw}_x \wedge \text{aw}_y \wedge \bigvee_{z \in \mathbf{A}} \left(\text{aw}_z \wedge \text{r}_{z,y} \wedge [\text{transClosure}] \text{s}_{x,z} \right) \end{array}$$

And define a DL-PA program that adds these attacks to \mathcal{B}_v :

$$\begin{array}{l} \text{addAttacks}^{\text{ded}} = \text{;}_{x,y \in \mathbf{A}} \left(\text{if } (\text{r}_{x,y}^{\text{aw}} \vee \text{r}_{x,y}^{\text{case1}} \vee \text{r}_{x,y}^{\text{case2}}) \text{ then } +\text{r}'_{x,y}; \text{else skip} \right); \\ \text{mkFalseAll}(\text{ATT}_{\mathbf{A} \times \mathbf{A}}); \\ \text{;}_{x,y \in \mathbf{A}} \left(\text{if } \text{r}'_{x,y} \text{ then } +\text{r}_{x,y} \text{ else skip} \right) \end{array}$$

Note that this program makes use of a set of fresh copies of attack variables $\text{ATT}'_{\mathbf{A} \times \mathbf{A}} = \{\mathbf{r}'_{x,y} \mid (x,y) \in \mathbf{A} \times \mathbf{A}\}$. By duality (Sec. 2), we can easily go from one interpretation to the other using the following DL-PA program:

$$\begin{array}{l} \text{necessary2deductive} = \begin{array}{l} \dot{;}_{x,y \in \mathbf{A}} (\text{if } \mathbf{s}_{y,x} \text{ then } +\mathbf{s}'_{x,y}; \text{ else skip}); \\ \text{mkFalseAll}(\text{SUP}_{\mathbf{A} \times \mathbf{A}}); \\ \dot{;}_{x,y \in \mathbf{A}} (\text{if } \mathbf{s}'_{x,y} \text{ then } +\mathbf{s}_{x,y}; \text{ else skip}) \end{array} \end{array}$$

Hence, we can abbreviate $\text{addAttacks}^{\text{nec}} = \text{necessary2deductive}; \text{addAttacks}^{\text{ded}}$.

Proposition 8 *Let $\mathcal{B} = \langle \mathcal{A}, \mathcal{R}, \mathcal{S} \rangle$ be a BAF, let $\mathbf{t} \in \{\text{nec}, \text{ded}\}$, and let σ be an argumentation semantics, we have that*

$$\sigma^{\mathbf{t}}(\mathcal{B}) = \{\mathbf{E}_{v'} \mid (v_{\mathcal{B}}, v') \in \|\text{addAttacks}^{\mathbf{t}}; \text{mkExt}^{\sigma}\|\}.$$

Computing Completions of IBAFs in DL-PA. All the notions of completion discussed in Sec. 3 can be computed by DL-PA programs. First, let us define the **valuation associated to** $\mathcal{IB} = \langle \mathcal{A}, \mathcal{A}^?, \mathcal{R}, \mathcal{R}^?, \mathcal{S}, \mathcal{S}^? \rangle$ as $v_{\mathcal{IB}} = v_{\langle \mathcal{A}, \mathcal{R}, \mathcal{S} \rangle}$. Plain completions of \mathcal{IB} are computed by:

$$\begin{array}{l} \text{mkComp}^{\text{pla}}(\mathcal{IB}) = \begin{array}{l} \text{mkTrueSome}(\text{AW}_{\mathcal{A}^?}); \\ \text{mkTrueSome}(\text{ATT}_{\mathcal{R}^?}); \text{mkTrueSome}(\text{ATT}_{\mathcal{S}^?}) \end{array} \end{array}$$

For semantic and closed completions, it is necessary to check whether the corresponding additional constraint is satisfied after each execution of $\text{mkComp}^{\text{pla}}(\mathcal{IB})$. We use yet another set of fresh copies $\text{SUP}''_{\mathbf{A} \times \mathbf{A}} = \{\mathbf{s}''_{x,y} \mid (x,y) \in \mathbf{A} \times \mathbf{A}\}$, and define the program:

$$\text{copy}''(\text{SUP}_{\mathbf{A} \times \mathbf{A}}) = \dot{;}_{x,y \in \mathbf{A}} (\text{if } \mathbf{s}_{x,y} \text{ then } +\mathbf{s}''_{x,y}; \text{ else skip})$$

Now, the constraints corresponding to each kind of completion are:

$$\begin{array}{l} \text{Constraint}^{\text{nec}} = \bigwedge_{x,y \in \mathbf{A}} ((\mathbf{in}_x \wedge \mathbf{s}''_{y,x}) \rightarrow \mathbf{in}_y) \\ \text{Constraint}^{\text{ded}} = \bigwedge_{x,y \in \mathbf{A}} ((\mathbf{in}_x \wedge \mathbf{s}''_{x,y}) \rightarrow \mathbf{in}_y) \\ \text{Constraint}^{\text{cnec}} = \bigwedge_{x,y \in \mathbf{A}} ((\mathbf{aw}_x \wedge \mathbf{s}''_{y,x}) \rightarrow \mathbf{aw}_y) \\ \text{Constraint}^{\text{cded}} = \bigwedge_{x,y \in \mathbf{A}} ((\mathbf{aw}_x \wedge \mathbf{s}''_{x,y}) \rightarrow \mathbf{aw}_y) \end{array}$$

For $\mathbf{t} \in \{\text{ded}, \text{nec}\}$, we define:

$$\begin{array}{l} \text{mkComp}_{\sigma}^{\mathbf{t}}(\mathcal{IB}) = \begin{array}{l} \text{copy}''(\text{SUP}_{\mathbf{A} \times \mathbf{A}}); \text{mkComp}^{\text{pla}}(\mathcal{IB}); \\ ([\text{addAttacks}^{\mathbf{t}}; \text{mkExt}^{\sigma}] \text{Constraint}^{\mathbf{t}})? \end{array} \end{array}$$

and for $\mathbf{t} \in \{\text{cnec}, \text{cded}\}$, we define:

$$\begin{array}{l} \text{mkComp}_{\sigma}^{\mathbf{t}}(\mathcal{IB}) = \begin{array}{l} \text{copy}''(\text{SUP}_{\mathbf{A} \times \mathbf{A}}); \text{mkComp}^{\text{pla}}(\mathcal{IB}); \text{Constraint}^{\mathbf{t}}? \end{array} \end{array}$$

Proposition 9 *Let $\mathcal{IB} = \langle \mathcal{A}, \mathcal{A}^?, \mathcal{R}, \mathcal{R}^?, \mathcal{S}, \mathcal{S}^? \rangle$, $\mathbf{t} \in \{\text{pla}, \text{nec}, \text{ded}, \text{cnec}, \text{cded}\}$, and let σ be a semantics. Then:*

- *If $\langle v_{\mathcal{IB}}, v \rangle \in \|\text{mkComp}_{\sigma}^{\mathbf{t}}(\mathcal{IB})\|$, then $\langle \mathcal{A}_v, \mathcal{R}_v, \mathcal{S}_v \rangle \in \text{completions}_{\sigma}^{\mathbf{t}}(\mathcal{IB})$.*
- *If $\langle \mathcal{A}_c, \mathcal{R}_c, \mathcal{S}_c \rangle \in \text{completions}_{\sigma}^{\mathbf{t}}(\mathcal{IB})$, then there is a $v \subseteq \text{Prp}$ s.t. $v \cap \text{Prp}_{\mathbf{A}} = v_{\langle \mathcal{A}_c, \mathcal{R}_c, \mathcal{S}_c \rangle}$ and $\langle v_{\mathcal{IB}}, v \rangle \in \|\text{mkComp}_{\sigma}^{\mathbf{t}}(\mathcal{IB})\|$.*

Argument Acceptance for IBAFs in DL-PA. Our final proposition is:

Proposition 10 *Let $\mathcal{IB} = \langle \mathcal{A}, \mathcal{A}^?, \mathcal{R}, \mathcal{R}^?, \mathcal{S}, \mathcal{S}^? \rangle$, let $a \in \mathcal{A}$, let $\sigma \in \{\text{co}, \text{pr}, \text{gr}, \text{st}\}$, let $\mathbf{t}_1 \in \{\text{pla}, \text{nec}, \text{ded}, \text{cnec}, \text{cded}\}$ and $\mathbf{t}_2 \in \{\text{nec}, \text{ded}\}$ s.t. if $\mathbf{t}_1 \in \{\text{nec}, \text{ded}\}$, then $\mathbf{t}_1 = \mathbf{t}_2$; and if $\mathbf{t}_1 \in \{\text{cnec}, \text{cded}\}$, then $\mathbf{t}_1 = \mathbf{ct}_2$. Then:*

- *The answer to σ^{t_2} - t_1 -PCA with input \mathcal{IB} and a is YES iff $v_{\mathcal{IB}} \models \langle \text{mkComp}_{\sigma}^{t_1}(\mathcal{IB}); \text{addAttacks}^{t_2}; \text{mkExt}^{\sigma} \rangle \text{in}_a$.*
- *The answer to σ^{t_2} - t_1 -NCA with input \mathcal{IB} and a is YES iff $v_{\mathcal{IB}} \models [\text{mkComp}_{\sigma}^{t_1}(\mathcal{IB})] \langle \text{addAttacks}^{t_2}; \text{mkExt}^{\sigma} \rangle \text{in}_a$.*
- *The answer to σ^{t_2} - t_1 -PSA with input \mathcal{IB} and a is YES iff $v_{\mathcal{IB}} \models \langle \text{mkComp}_{\sigma}^{t_1}(\mathcal{IB}) \rangle [\text{addAttacks}^{t_2}; \text{mkExt}^{\sigma}] \text{in}_a$.*
- *The answer to σ^{t_2} - t_1 -NSA with input \mathcal{IB} and a is YES iff $v_{\mathcal{IB}} \models [\text{mkComp}_{\sigma}^{t_1}(\mathcal{IB}); \text{addAttacks}^{t_2}; \text{mkExt}^{\sigma}] \text{in}_a$.*

Usefulness of the Encoding. Our translation of IBAFs to DL-PA follows a tradition of capturing abstract argumentation in this lightweight version of dynamic logic [19, 21, 20, 29, 45]. As such, the reasons given throughout this branch of the literature to justify the usefulness of this technique are naturally inherited by our approach. We here recall some of them and add a few more.

When compared to propositional encodings of argumentation formalisms (e.g., [9]), DL-PA permits representing notions that require maximality and minimality checkings (e.g., preferred and grounded semantics) more succinctly. While propositional formulas capturing these semantics are exponentially long (w.r.t. the size of the background set of arguments \mathbf{A}), their DL-PA analogues are polynomially long (c.f. [20, 45]).

When compared to encodings in equally succinct languages (e.g., Quantified Boolean Formulas QBFs), we are aware that not everything is advantageous. The main shortcoming of our encoding against those based on QBFs is the absence (up to date) of an efficient DL-PA solver, which prevents our approach from being empirically tested. However, this is by no means an essential limitation. Rather, it can be taken as an additional motivational reason to develop the missing tools because using DL-PA as a language for abstract argumentation formalisms has several strong advantages. First of all, it makes things simpler: it is enough to compare the rather complex encodings of IAFs in QBFs [7], to our simple DL-PA programs and formulas for IAFs. We think that this is in part due to the presence of imperative programming constructs in the DL-PA object language, which allows for assigning an intuitively clear meaning to programs that are later employed in the construction of more complex ones. That leads to the second advantage of our encoding approach: its modularity. Since we already had DL-PA programs for computing AFs extensions and IAFs completions, it was enough to plug them into programs capturing bipolarity (where “plugging-in” amounted most of the time to the use of the sequential composition operator ‘;’). As a third advantage, the dynamic nature of DL-PA makes it a more suitable logical tool for the study of dynamic extensions of IBAFs (e.g., IBAFs where new arguments, supports or attacks are added). Last but not least, although polynomial encodings of IBAFs in QBFs must exist (because QBFs and DL-PA are equally expressive and succinct [2]), they are still not known.

6 Conclusion

This paper was devoted to moving forward in the study of IBAFs: enriched frameworks for abstract argumentation taking into account two kinds of interaction between arguments (attacks and necessary or deductive supports) and considering at the same time that the elements (arguments or interactions) of this framework can be uncertain. Reasoning about IBAFs is done through the notion of completion: any uncertain element can be considered present or absent and so several “variants” of the IBAF may be built, each variant is called *completion* and corresponds to a classical BAF without uncertainty. Then, the semantics of IBAFs are defined by the application of the corresponding semantics on these completions. The focus of the paper has been the discussion and comparison of three different notions of completions. The first one, already studied in [27, 32] and called *plain completions*, corresponds to the notion of *conditionally certain support* whereas the other ones introduce the notion of *unconditionally certain support* using either semantic constraint (an idea already presented in [32], that we call here *semantic completions*) or syntactical ones (*closed completions*, firstly studied here). Tight complexity results are given for plain and closed completions, while lower and upper bounds are provided for semantic ones. Finally, arguments acceptability problems with respect to IBAFs using any of the three variants of completions are shown to be reducible to DL-PA model checking.

In terms of future work, several directions can be explored. First, we could complete this study for IBAFs taking into account some other enriched abstract frameworks (for instance those with evidential support relations, or with higher-order interactions, or with collective ones). A second line of future work could be the study of instantiations of IBAFs into *structured* frameworks (see for instance [40, 46] for recent instantiation of IAFs). Along these lines, we think that the notion of closed completion introduced in this paper can serve as a bridge between two different lines of work on instantiating abstract argumentation frameworks into structured ones [16, 46]. In [16], deductive supports (without uncertainty) are shown to be in strong correspondence with the inverse subargument relation among structured arguments in ASPIC⁺ theories[37].⁹ In [46], it is shown that if one understands argument-incomplete AFs (IAFs with an empty $\mathcal{R}^?$) as ASPIC⁺ theories with incomplete sets of inference rules (a hypothesis previously made by [7]), then the resulting completions are closed under subarguments (or, more precisely, are closed under the inverse subargument relation: if an argument appears in an completion, then its subarguments appear in it too). Putting both ideas together we have that completions should be closed under deductive supports, which is precisely what we captured with closed completions. A third interesting point could be to implement the computation of semantics of all these incomplete frameworks via the development of a DL-PA solver and to make some experiments for evaluating our encoding

⁹[16] actually shows the correspondence between the subargument relation and necessary supports, hence the one between deductive supports and the inverse subargument relation follows from duality.

and comparing with other approaches (perhaps with a more direct computation of semantics without using logics). Finally, a fourth line of future research consists in focusing on the uncertainty aspect of IBAFs by, e.g., considering a recursive form of uncertainty [42], or proposing a direct approach (i.e. without using completions) to define extension-based semantics in the style of [34].

Acknowledgments

We want to acknowledge our colleague Sylvie Doutre for the very rich exchanges about the topic of this paper.

References

- [1] Leila Amgoud and Claudette Cayrol. A reasoning model based on the production of acceptable arguments. *Ann. Math. Artif. Intell.*, 34(1-3):197–215, 2002.
- [2] Philippe Balbiani, Andreas Herzig, François Schwarzentruber, and Nicolas Troquard. Dl-pa and dcl-pc: model checking and satisfiability problem are indeed in pspace. *arXiv preprint arXiv:1411.7825*, 2014.
- [3] Philippe Balbiani, Andreas Herzig, and Nicolas Troquard. Dynamic logic of propositional assignments: a well-behaved variant of pdl. In *Proc. of LICS'13*, pages 143–152, 2013.
- [4] Pietro Baroni, Martin Caminada, and Massimiliano Giacomin. Abstract argumentation frameworks and their semantics. In *Handbook of Formal Argumentation*, pages 159–236. College Publications, 2018.
- [5] Pietro Baroni, Massimiliano Giacomin, and Giovanni Guida. Extending abstract argumentation systems theory. *Artif. Intell.*, 120(2):251–270, 2000.
- [6] Howard Barringer, Dov Gabbay, and John Woods. Temporal dynamics of support and attack networks : From argumentation to zoology. In Dieter Hutter and Werner Stephan, editors, *Mechanizing Mathematical Reasoning, Essays in Honor of Jörg H. Siekmann. LNAI 2605*, pages 59–98. Springer, 2005.
- [7] Dorothea Baumeister, Matti Järvisalo, Daniel Neugebauer, Andreas Niskanen, and Jörg Rothe. Acceptance in incomplete argumentation frameworks. *Artif. Intell.*, 295:103470, 2021.
- [8] Dorothea Baumeister, Daniel Neugebauer, Jörg Rothe, and Hilmar Schadrack. Verification in incomplete argumentation frameworks. *Artif. Intell.*, 264:1–26, 2018.
- [9] Philippe Besnard and Sylvie Doutre. Checking the acceptability of a set of arguments. In *10th International Workshop on Non-Monotonic Reasoning (NMR 2004)*, pages 59–64, 2004.
- [10] Guido Boella, Dov M. Gabbay, Leendert W. N. van der Torre, and Serena Villata. Support in abstract argumentation. In *Proc. of COMMA'10*, pages 111–122, 2010.
- [11] Álvaro Carrera and Carlos A Iglesias. A systematic review of argumentation techniques for multi-agent systems research. *Artif. Intell. Rev.*, 44(4):509–535, 2015.
- [12] Claudette Cayrol, Andrea Cohen, and Marie-Christine Lagasquie-Schiex. Higher-order interactions (bipolar or not) in abstract argumentation: A state of the art. In *Handbook of Formal Argumentation, Volume 2*, pages 3–118. College Publications, 2021.

- [13] Claudette Cayrol and Marie-Christine Lagasquie-Schiex. On the acceptability of arguments in bipolar argumentation frameworks. In *Proc. of ECSQARU'05*, pages 378–389, 2005.
- [14] Claudette Cayrol and Marie-Christine Lagasquie-Schiex. Bipolarity in argumentation graphs: Towards a better understanding. *Int. J. Approx. Reason.*, 54(7):876–899, 2013.
- [15] Andrea Cohen, Alejandro Javier García, and Guillermo Ricardo Simari. Backing and undercutting in abstract argumentation frameworks. In *Proc. of FoIKS'12*, pages 107–123, 2012.
- [16] Andrea Cohen, Simon Parsons, Elizabeth I Sklar, and Peter McBurney. A characterization of types of support between structured arguments and their relationship with support in abstract argumentation. *International Journal of Approximate Reasoning*, 94:76–104, 2018.
- [17] Sylvie Coste-Marquis, Caroline Devred, Sébastien Konieczny, Marie-Christine Lagasquie-Schiex, and Pierre Marquis. On the merging of Dung’s argumentation systems. *Artif. Intell.*, 171(10-15):730–753, 2007.
- [18] Kristijonas Cyras, Claudia Schulz, and Francesca Toni. Capturing bipolar argumentation in non-flat assumption-based argumentation. In *Proc. of PRIMA'17*, pages 386–402, 2017.
- [19] Sylvie Doutre, Andreas Herzig, and Laurent Perrussel. A dynamic logic framework for abstract argumentation. In *Proc. of KR'14*, 2014.
- [20] Sylvie Doutre, Andreas Herzig, and Laurent Perrussel. Abstract argumentation in dynamic logic: Representation, reasoning and change. In *Proc. of CLAR'18*, pages 153–185, 2018.
- [21] Sylvie Doutre, Faustine Maffre, and Peter McBurney. A dynamic logic framework for abstract argumentation: adding and removing arguments. In *Proc. of IEA/AIE'17*, pages 295–305, 2017.
- [22] Phan Minh Dung. On the acceptability of arguments and its fundamental role in nonmonotonic reasoning, logic programming and n-person games. *Artif. Intell.*, 77(2):321–358, 1995.
- [23] Wolfgang Dvorák and Paul E. Dunne. Computational problems in formal argumentation and their complexity. In Pietro Baroni, Dov Gabbay, Massimiliano Giacomin, and Leendert van der Torre, editors, *Handbook of Formal Argumentation*, pages 631–688. College Publications, 2018.
- [24] Bettina Fazzinga, Sergio Flesca, and Filippo Furfaro. Probabilistic bipolar abstract argumentation frameworks: complexity results. In *Proc. of IJCAI'18*, pages 1803–1809, 2018.

- [25] Bettina Fazzinga, Sergio Flesca, and Filippo Furfaro. Reasoning over argument-incomplete AAFs in the presence of correlations. In Zhi-Hua Zhou, editor, *Proc. of IJCAI' 20'21*, pages 189–195. ijcai.org, 2021.
- [26] Bettina Fazzinga, Sergio Flesca, and Filippo Furfaro. Reasoning over attack-incomplete AAFs in the presence of correlations. In Meghyn Bienvenu, Gerhard Lakemeyer, and Esra Erdem, editors, *Proc. of KR21*, pages 301–311, 2021.
- [27] Bettina Fazzinga, Sergio Flesca, and Filippo Furfaro. Incomplete bipolar argumentation frameworks. In K. Gal et al., editor, *Proc. of ECAI'23*, pages 684–691. IOS Press, 2023.
- [28] Anis Gargouri, Sébastien Konieczny, Pierre Marquis, and Srdjan Vesic. On a notion of monotonic support for bipolar argumentation frameworks. In *Proc. of AAMAS'21*, pages 546–554, 2021.
- [29] Andreas Herzig and Antonio Yuste-Ginel. Abstract argumentation with qualitative uncertainty: An analysis in dynamic logic. In *Proc. of CLAR'21*, pages 190–208. Springer, 2021.
- [30] Anthony Hunter, Sylwia Polberg, Nico Potyka, Tjitze Rienstra, and Matthias Thimm. Probabilistic argumentation: A survey. In *Handbook of Formal Argumentation, Volume 2*, pages 397–441. College Publications, 2021.
- [31] Amin Karamlou, Kristijonas Cyras, and Francesca Toni. Complexity results and algorithms for bipolar argumentation. In *Proc. of AAMAS'19*, pages 1713–1721, 2019.
- [32] Marie-Christine Lagasquie-Schieux, Jean-Guy Mailly, and Antonio Yuste-Ginel. Incomplete Bipolar Argumentation Frameworks. Technical Report IRIT/RR–2023–01–FR, IRIT - Institut de Recherche en Informatique de Toulouse, May 2023.
- [33] Jean-Guy Mailly. Constrained incomplete argumentation frameworks. In Jirina Vejnárová and Nic Wilson, editors, *Proc. of ECSQARU'21*, volume 12897 of *Lecture Notes in Computer Science*, pages 103–116. Springer, 2021.
- [34] Jean-Guy Mailly. Extension-based semantics for incomplete argumentation frameworks. In *Proc. of CLAR'21*, pages 322–341, 2021.
- [35] Jean-Guy Mailly. Yes, no, maybe, I don't know: Complexity and application of abstract argumentation with incomplete knowledge. *Argument Comput.*, 13(3):291–324, 2022.
- [36] Hugo Mercier and Dan Sperber. Why do humans reason? arguments for an argumentative theory. *Behavioral and brain sciences*, 34(2):57–74, 2011.

- [37] Sanjay Modgil and Henry Prakken. The aspic+ framework for structured argumentation: a tutorial. *Argument & Computation*, 5(1):31–62, 2014.
- [38] Søren Holbech Nielsen and Simon Parsons. A generalization of Dung’s abstract framework for argumentation: Arguing with sets of attacking arguments. In Nicolas Maudet, Simon Parsons, and Iyad Rahwan, editors, *Argumentation in Multi-Agent Systems - Third International Workshop (ArgMAS 2006)*, volume 4766 of *Lecture Notes in Artificial Intelligence*, pages 54–73, Hakodate, Japan, May 2006. Springer.
- [39] Farid Nouioua and Vincent Risch. Argumentation frameworks with necessities. In *Proc. of SUM’11*, volume 6929, pages 163–176, 2011.
- [40] Daphne Odekerken, Tuomo Lehtonen, AnneMarie Borg, Johannes P. Wallner, and Matti Järvisalo. Argumentative Reasoning in ASPIC+ under Incomplete Information. In *Proc. of KR’23*, pages 531–541, 2023.
- [41] Nir Oren and Timothy J. Norman. Semantics for evidence-based argumentation. In *Proc. of COMMA’08*, volume 172, pages 276–284. IOS Press, 2008.
- [42] Tjitze Rienstra, Matthias Thimm, and Nir Oren. Opponent models with uncertainty for strategic argumentation. In *Proc. of IJCAI’13*, 2013.
- [43] Julien Rossit, Jean-Guy Mailly, Yannis Dimopoulos, and Pavlos Moraitis. United we stand: Accruals in strength-based argumentation. *Argument Comput.*, 12(1):87–113, 2021.
- [44] Liuwen Yu, Caren Al Anaissy, Srdjan Vesic, Xu Li, and Leendert van der Torre. A principle-based analysis of bipolar argumentation semantics. In *Proc. of JELIA’23*, 2023.
- [45] Antonio Yuste-Ginel and Andreas Herzig. Qualitative uncertainty and dynamics of argumentation through dynamic logic. *J. Log. Comput.*, 2023. exac098.
- [46] Antonio Yuste-Ginel and Carlo Proietti. On the instantiation of argument-incomplete argumentation frameworks. In G. Alfano and S. Ferilli, editors, *7th Workshop on Advances in Argumentation in Artificial Intelligence*. CEUR, 2022.

A Proofs

A.1 Proofs for Section 2

Proposition 1 Let $\mathcal{B} = \langle \mathcal{A}, \mathcal{R}, \mathcal{S} \rangle$ be a BAF. Let the interpretation $\mathbf{t} \in \{\text{ded}, \text{nec}\}$. Let $\sigma \in \{\text{co}, \text{gr}, \text{pr}, \text{st}\}$ be a semantics. $\sigma_c^{\mathbf{t}}(\mathcal{B}) = \sigma^{\mathbf{t}}(\mathcal{B})$.

Proof: By definition, proving that a c - σ -extension is a σ -extension is obvious, E being a σ -extension closed for \mathcal{S} .

Let consider now a σ -extension E and prove that E is a c - σ -extension for $\sigma \in \{\text{co}, \text{gr}, \text{pr}, \text{st}\}$. This proof uses some intermediate results:

1. Let $(a, b) \in \mathcal{S}$. In $(\mathcal{A}, \mathcal{R}^{\text{ded}})$ (resp. $(\mathcal{A}, \mathcal{R}^{\text{nec}})$), if b (resp. a) is attacked by an argument c then c also attacks a (resp. b). Similarly, if b (resp. a) attacks an argument c then c is also attacked by a (resp. b).

Proof of Intermediate Result 1 We only give here the proof for the **ded** case (the proof concerning the **nec** case can be obtained similarly exchanging the role of a and b). If c attacks b then (c, a) belongs to \mathcal{R}^{ded} (a Case 1 attack). If c is attacked by b then (a, c) belongs to \mathcal{R}^{ded} (a Case 2 attack).

2. Let $(a, b) \in \mathcal{S}$. In $(\mathcal{A}, \mathcal{R}^{\text{ded}})$ (resp. $(\mathcal{A}, \mathcal{R}^{\text{nec}})$), if a (resp. b) is defended against all its attackers by a given set of arguments E then b (resp. a) is also defended against all its attackers by the same set E .

Proof of Intermediate Result 2 We only give here the proof for the **ded** case (the proof concerning the **nec** case can be obtained similarly exchanging the role of a and b). Two cases appear here: either b is unattacked in \mathcal{R}^{ded} , or it is attacked by an argument c . In the first case, b is trivially defended whatever is E . In the second case, an attack (c, a) belongs to \mathcal{R}^{ded} (a Case 1 attack). So c is an attacker of a and since a is defended against c by E then b is also defended against c by E .

3. Let $(a, b) \in \mathcal{S}$. In $(\mathcal{A}, \mathcal{R}^{\text{ded}})$ (resp. $(\mathcal{A}, \mathcal{R}^{\text{nec}})$), if (a, b) or (b, a) belong to \mathcal{R}^{ded} (resp. \mathcal{R}^{nec}), then a (resp. b) is a self-attacking argument.¹⁰

Proof of Intermediate Result 3 We only give here the proof for the **ded** case (the proof concerning the **nec** case can be obtained similarly exchanging the role of a and b). Four cases appear here:

- $(a, b) \in \mathcal{R}$: so a Case 1 attack (a, a) belongs to \mathcal{R}^{ded} .
- $(b, a) \in \mathcal{R}$: so a Case 2 attack (a, a) belongs to \mathcal{R}^{ded} .
- $(a, b) \notin \mathcal{R}$, $(b, a) \notin \mathcal{R}$ but $(a, b) \in \mathcal{R}^{\text{ded}}$. If (a, b) is a Case 1 attack, then there exist the attack (a, c) and the support (b, c) in \mathcal{R}^{ded} . So a Case 1 attack (a, a) belongs to \mathcal{R}^{ded} . If (a, b) is a Case 2 attack, then there exist the support (a, c) and the attack (c, b) in \mathcal{R}^{ded} . So a Case 1 attack (a, a) belongs to \mathcal{R}^{ded} .

¹⁰This result is not useful for the proof of Prop. 1. Nevertheless, it is interesting.

- $(a, b) \notin \mathcal{R}$, $(b, a) \notin \mathcal{R}$ but $(b, a) \in \mathcal{R}^{\text{ded}}$. If (b, a) is a Case 1 attack, then there exist the attack (b, c) and the support (a, c) in \mathcal{R}^{ded} . So a Case 2 attack (a, a) belongs to \mathcal{R}^{ded} . If (b, a) is a Case 2 attack, then there exist the support (b, c) and the attack (c, a) in \mathcal{R}^{ded} . So a Case 2 attack (a, a) belongs to \mathcal{R}^{ded} .

Now let show that a complete extension E of $(\mathcal{A}, \mathcal{R}^{\text{ded}})$ is also closed for \mathcal{S} . Let $(a, b) \in \mathcal{S}$ and assume that $a \in E$. Let prove that:

- $E \cup \{b\}$ is conflict-free: if it is not the case then there exists $c \in E$ that either attacks b or is attacked by b ; so following the intermediate result 1, either c attacks a or it is attacked by a ; so, in each case, E is not conflict-free, thus a contradiction.
- E defends b : this obviously follows to the intermediate result 2.
- E contains b : E being complete and defending b then, by definition, b belongs to E .

Thus following the last item, E is closed for \mathcal{S} .

Let us consider now $\sigma = \text{gr}$ or $\sigma = \text{pr}$. By definition, the grounded extension and each preferred extension are complete extensions. So following the result concerning $\sigma = \text{co}$, they are also closed for \mathcal{S} .

Finally let us consider $\sigma = \text{st}$ and E be a stable extension. Assume that E is not closed for \mathcal{S} for a given support (a, b) . So $a \in E$ and $b \in \mathcal{A} \setminus E$. Thus there exists an attacker of b , $c \in E$. Following the intermediate result 1, c is also an attacker of a and so E is not conflict-free and so not stable. Contradiction.

Then, in any case, for $\sigma \in \{\text{co}, \text{gr}, \text{pr}, \text{st}\}$, any σ -extension is also a c - σ -extension.

The same proof can be done for $\text{t} = \text{nec}$, considering the appropriate definition for the closure of the support. \square

A.2 Proofs for Section 3

Proposition 2 Let \mathcal{IB} be an IBAF with a t interpretation for the support ($\text{t} \in \{\text{ded}, \text{nec}\}$) and $\mathcal{A}^? = \mathcal{R}^? = \mathcal{S}^? = \emptyset$. Let $\sigma \in \{\text{pr}, \text{gr}, \text{co}, \text{st}\}$ be a semantics. $\sigma^{\text{t-pla}}(\mathcal{IB}) = \sigma^{\text{t}}(\mathcal{IB}) = \sigma^{\text{ct}}(\mathcal{IB})$.

Proof: Without uncertainty, there is only one pla -completion that contains all the arguments, attacks and supports described in \mathcal{IB} . So \mathcal{IB} is a BAF and, following Def. 2, it is also a ct -completion whatever is $\text{t} \in \{\text{ded}, \text{nec}\}$. Moreover its $\sigma^{\text{t-pla}}$ -extensions are also its σ -extensions under the interpretation t . Moreover, due to the fact that any σ -extension is also a c - σ -extension (see Prop. 1), the second condition in Def. 2 is trivially satisfied by any σ -extension and we can conclude that the unique pla -completion is also a t -completion, whatever is the chosen semantics σ . Thus $\sigma^{\text{t-pla}}(\mathcal{IB}) = \sigma^{\text{t}}(\mathcal{IB}) = \sigma^{\text{ct}}(\mathcal{IB})$ for a given $\text{t} \in \{\text{ded}, \text{nec}\}$. \square

Proposition 3 Let \mathcal{IB} be an IBAF with a \mathbf{t} interpretation for the support ($\mathbf{t} \in \{\mathbf{ded}, \mathbf{nec}\}$). Let $\sigma \in \{\mathbf{pr}, \mathbf{gr}, \mathbf{co}, \mathbf{st}\}$ be a semantics. We have:

- $\text{completions}^{\mathbf{ct}}(\mathcal{IB}) \subseteq \text{completions}_{\sigma}^{\mathbf{t}}(\mathcal{IB}) \subseteq \text{completions}^{\mathbf{pla}}(\mathcal{IB})$. The reverse does not hold.
- $\sigma^{\mathbf{ct}}(\mathcal{IB}) \subseteq \sigma^{\mathbf{t}}(\mathcal{IB}) \subseteq \sigma^{\mathbf{t-pla}}(\mathcal{IB})$. The reverse does not hold.

Proof:

- By Def. 2, $\text{completions}^{\mathbf{ct}}(\mathcal{IB}) \subseteq \text{completions}^{\mathbf{pla}}(\mathcal{IB})$ and $\text{completions}_{\sigma}^{\mathbf{t}}(\mathcal{IB}) \subseteq \text{completions}^{\mathbf{pla}}(\mathcal{IB})$ whatever is $\sigma \in \{\mathbf{pr}, \mathbf{gr}, \mathbf{co}, \mathbf{st}\}$. So it remains to prove that $\text{completions}^{\mathbf{ct}}(\mathcal{IB}) \subseteq \text{completions}_{\sigma}^{\mathbf{t}}(\mathcal{IB})$, for $\sigma \in \{\mathbf{pr}, \mathbf{gr}, \mathbf{co}, \mathbf{st}\}$.

For a given σ , let assume that the meaning of the support in \mathcal{IB} is the deductive one. Let \mathcal{B} be a \mathbf{cded} -completion and E be an extension of \mathcal{B} . Following Proposition 1, E is also a $\mathbf{c}\text{-}\sigma$ -extension. So, for any support $(a, b) \in \mathcal{B}$, if a is accepted then b must be accepted. Moreover since \mathcal{B} is a \mathbf{cded} -completion, only two cases are possible for any *certain* support (a, b) :

- either $a \in \mathcal{B}$ and so $b \in \mathcal{B}$; in this case since E is a $\mathbf{c}\text{-}\sigma$ -extension, then if a is accepted then b also is accepted; this holds whatever E and thus \mathcal{B} is a \mathbf{ded} -completion;
 - or $a \notin \mathcal{B}$ and so there is no constraint about b (b can or cannot belong to \mathcal{B}); in this case, obviously \mathcal{B} is a \mathbf{ded} -completion since a is never accepted in \mathcal{B} .
- For the reverse property about inclusion of completions, it is enough to consider the following counter-examples:
 - There exist \mathbf{pla} -completions that are not \mathbf{t} -completions (see for instance \mathcal{B}_1 in Ex. 4).
 - Some \mathbf{t} -completions are not \mathbf{ct} -completions; for instance let consider the certain support (a, b) and a completion \mathcal{B} such that $a \in \mathcal{B}$, $b \notin \mathcal{B}$ and a is never accepted in \mathcal{B} ; \mathcal{B} is a \mathbf{ded} -completion but not a \mathbf{cded} -completion.
 - The inclusion of the sets of extensions is obviously deduced from the inclusion of the completions.
 - For the reverse property about inclusion of sets of extensions, it is enough to consider the following counter-examples:
 - Let consider Ex. 4): the set $\{a_0, a_1, a_3, a_5, a_6\}$ belongs to $\sigma^{\mathbf{ded-pla}}(\mathcal{IB})$ but not to $\sigma^{\mathbf{ded}}(\mathcal{IB})$, whatever is $\sigma \in \{\mathbf{pr}, \mathbf{gr}, \mathbf{co}, \mathbf{st}\}$.
 - Let consider the following \mathcal{IB} :

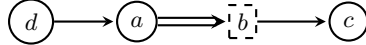

There are 2 \mathbf{pla} -completions, one with b denoted by \mathcal{B}_1 and another one without b denoted by \mathcal{B}_2 . Whatever is $\sigma \in \{\mathbf{pr}, \mathbf{gr}, \mathbf{co}, \mathbf{st}\}$, there is one σ -extension in \mathcal{B}_1 : $\{d, b\}$ and there is one σ -extension in \mathcal{B}_2 : $\{d, c\}$. Each extension respects the constraint given by Condition 2 in Def. 2. So \mathcal{B}_1 and \mathcal{B}_2 are \mathbf{ded} -completions wrt σ for \mathcal{IB} and thus $\sigma^{\mathbf{ded}}(\mathcal{IB}) = \{\{d, b\}, \{d, c\}\}$.

Moreover only \mathcal{B}_1 is a *cded*-completion and thus $\sigma^{\text{cded}}(\mathcal{I}\mathcal{B}) = \{\{d, b\}\}$. So $\sigma^{\text{ded}}(\mathcal{I}\mathcal{B})$ is not included in $\sigma^{\text{cded}}(\mathcal{I}\mathcal{B})$.

The same proof can be done for the necessary case. □

Proposition 4 Let $\mathcal{I}\mathcal{B}$ be an IBAF with a deductive interpretation for the support. Let $\sigma \in \{\text{pr}, \text{gr}, \text{co}, \text{st}\}$ be a semantics. Let $I_\sigma^c(\mathcal{I}\mathcal{B})$ (resp. $I_\sigma^d(\mathcal{I}\mathcal{B})$) be the set of the i-extensions under the c - σ (resp. d - σ) semantics for $\mathcal{I}\mathcal{B}$ as defined in [27].

- $\sigma^{\text{t-pla}}(\mathcal{I}\mathcal{B}) = I_\sigma^d(\mathcal{I}\mathcal{B}) = I_\sigma^c(\mathcal{I}\mathcal{B})$
- $\sigma^{\text{cded}}(\mathcal{I}\mathcal{B}) \subseteq \sigma^{\text{ded}}(\mathcal{I}\mathcal{B}) \subseteq I_\sigma^c(\mathcal{I}\mathcal{B})$. The reverse does not hold.

Proof:

- By definition, the completions defined in [27] are exactly the *pla*-completions. Moreover, the d - σ semantics correspond exactly to the classical σ semantics when we consider the three kinds of additional attacks whatever is $\sigma \in \{\text{pr}, \text{gr}, \text{co}, \text{st}\}$ and these semantics also correspond to the c -semantics (see Prop 1). The result follows obviously.
- First, let prove that $\sigma^{\text{ded}}(\mathcal{I}\mathcal{B}) \subseteq I_\sigma^c(\mathcal{I}\mathcal{B})$ for $\sigma \in \{\text{pr}, \text{gr}, \text{co}, \text{st}\}$. So let consider $E \in \sigma^{\text{ded}}(\mathcal{I}\mathcal{B})$. By definition E is a σ -extension for at least a *ded*-completion \mathcal{B} of $\mathcal{I}\mathcal{B}$, \mathcal{B} being also a completion in the sense of [27]. Moreover, considering any support $(a, b) \in \mathcal{I}\mathcal{B}$, if a is accepted in E then b is also accepted since \mathcal{B} is a *ded*-completion. So E is closed for the support and a σ -extension. Thus E is an i-extension of $\mathcal{I}\mathcal{B}$ for the c - σ semantics, σ belonging to $\{\text{pr}, \text{gr}, \text{co}, \text{st}\}$. Moreover, following Prop. 3, we have $\sigma^{\text{cded}}(\mathcal{I}\mathcal{B}) \subseteq \sigma^{\text{ded}}(\mathcal{I}\mathcal{B}) \subseteq I_\sigma^c(\mathcal{I}\mathcal{B})$.

Secondly, let's prove that the reverse does not hold. For the relationship between $\sigma^{\text{ded}}(\mathcal{I}\mathcal{B})$ and $I_\sigma^c(\mathcal{I}\mathcal{B})$, it is enough to consider Ex. 4. In this example and using the definitions given in [27], the set $\{a_0, a_1, a_3, a_5, a_6\}$ is an i-extension under the c - σ semantics, σ belonging to $\{\text{pr}, \text{gr}, \text{co}, \text{st}\}$ whereas it is not a σ -extension belonging to $\sigma^{\text{ded}}(\mathcal{I}\mathcal{B})$. Moreover, following Prop 3, and the previous result, it is obvious that $I_\sigma^c(\mathcal{I}\mathcal{B})$ is not included in $\sigma^{\text{cded}}(\mathcal{I}\mathcal{B})$. □

A.3 Proofs for Section 4

Proposition 5 Let $\mathcal{I}\mathcal{B} = \langle \mathcal{A}, \mathcal{A}^?, \mathcal{R}, \mathcal{R}^?, \mathcal{S}, \mathcal{S}^? \rangle$ be an IBAF, and $\mathcal{B}^* = \langle \mathcal{A}^*, \mathcal{R}^*, \mathcal{S}^* \rangle$. Checking whether $\mathcal{B}^* \in \text{completions}_\sigma^{\text{t}}(\mathcal{I}\mathcal{B})$ (for $\text{t} \in \{\text{nec}, \text{ded}\}$) is in P for $\sigma = \text{gr}$, coNP-complete for $\sigma \in \{\text{ad}, \text{co}, \text{st}\}$ and Π_2^{P} -complete for $\sigma = \text{pr}$.

Proof: We start with the membership results. We focus on the complementary problem, *i.e.* checking if \mathcal{B}^* is *not* a t -completion. To do that, we need to guess a set of arguments $S \subseteq \mathcal{A}^*$ and a support $(a, b) \in \mathcal{S}^*$, and then check whether S is an extension such that $a \in S$ and $b \notin S$ (for $\text{t} = \text{ded}$), or $b \in S$ and $a \notin S$ (for $\text{t} = \text{nec}$). This check is polynomial for

$\sigma \in \{\text{ad}, \text{co}, \text{st}\}$ and in coNP for $\sigma = \text{pr}$, so the problem is in NP for the first ones, and in Σ_2^{P} for the last one, hence the result.

Now, let us show that these complexity upper bounds are tight. We focus on the case of $\text{t} = \text{ded}$. First, let us rephrase the conditions under which a completion is a “valid” ded -completion: \mathcal{B}^* is a ded -completion of \mathcal{IB} iff, $\forall (a, b) \in \mathcal{S}$ one of these conditions is true:

1. $a, b \in \mathcal{A}^*$ (and thus $(a, b) \in \mathcal{S}^*$),
2. $a \notin \mathcal{A}^*$ (and in this case, there is no constraint at all on b),
3. $a \in \mathcal{A}^*$, $b \notin \mathcal{A}^*$, and a is not credulously accepted in \mathcal{B}^* w.r.t. σ .

Now, we provide a polynomial time reduction from the complement problem of credulous acceptability in Dung’s AFs (which is coNP -complete for all semantics $\sigma \in \{\text{ad}, \text{co}, \text{st}, \text{pr}\}$, since credulous acceptability is NP -complete [23]) to our problem. Given an AF $\mathcal{F} = \langle \mathcal{A}, \mathcal{R} \rangle$ with $\mathcal{A} = \{a_1, \dots, a_n\}$, we define $\mathcal{IB} = \langle \mathcal{A}, \mathcal{A}^?, \mathcal{R}, \emptyset, \mathcal{S}, \emptyset \rangle$ where $\mathcal{A}^? = \{b\}$ and $\mathcal{S} = \{(a_1, b)\}$. This IBAF has two completions: one is identical to \mathcal{F} (which is a BAF $\mathcal{B}^* = \langle \mathcal{A}, \mathcal{R}, \emptyset \rangle$ with empty support), and the other one is the BAF where b and the support from a_1 to b are added to \mathcal{F} . Let us consider the first completion. Assume that a_1 is not credulously accepted in \mathcal{F} . Then, for the single certain support (a, b) in \mathcal{IB} , the condition of ded -completions is satisfied: a is not credulously accepted in \mathcal{B}^* (and so, trivially, b belongs to every extension containing a). Now, assume that a_1 is credulously accepted in \mathcal{F} . Then \mathcal{B}^* is not a valid ded -completion of \mathcal{IB} .

So, checking whether a completion is a ded -completion is at least as hard as checking if an argument is not credulously accepted in an AF, *i.e.* it is coNP -hard. The reasoning is analogous for the case of nec -completions.

Finally, we conclude with the case of the preferred semantics. We consider sceptical acceptability w.r.t. the preferred semantics for Dung’s AFs, which is Π_2^{P} -complete [23], and we propose a reduction to our problem. Let us consider an AF $\mathcal{F} = \langle \mathcal{A}, \mathcal{R} \rangle$ with $\mathcal{A} = \{a_1, \dots, a_n\}$. We build the IBAF $\mathcal{IB} = \langle \mathcal{A} \cup \{b_1\}, \{b_2\}, \mathcal{R} \cup \{(a_1, b_1)\}, \{(b_1, b_2)\}, \emptyset \rangle$, *i.e.* we add two fresh arguments (b_1 is certain and b_2 is uncertain), one certain attack (from a_1 to b_1) and one certain support (from b_1 to b_2). There are two completions (depending on the presence of b_2). We consider the completion where b_2 is absent, *i.e.* $\mathcal{B}^* = \langle \mathcal{A} \cup \{b_1\}, \mathcal{R} \cup \{(a_1, b_1)\}, \emptyset \rangle$. Assume that a_1 is sceptically accepted in \mathcal{F} under the preferred semantics. Then, since a_1 attacks b_1 , b_1 cannot belong to any preferred extension, and so the condition of ded -completions is satisfied (b_2 trivially belongs to any completion containing b_1). Now, if a_1 is not sceptically accepted, since it is the only attacker of b_1 then b_1 must belong to some preferred extensions (the ones not containing a_1), and these extensions do not contain b_2 , so the completion is not a ded -completion. So we conclude that checking whether a BAF is a ded -completion is Π_2^{P} -hard. The reasoning is analogous for nec -completions. \square

Proposition 6 For $\text{t} \in \{\text{nec}, \text{ded}\}$ the following complexity results hold:

- For $\sigma \in \{\text{ad}, \text{st}, \text{co}, \text{pr}\}$, $\sigma^t\text{-t-PCA}$ is NP-hard and in Σ_2^P , and NP-complete for $\sigma = \text{gr}$.
- For $\sigma \in \{\text{st}, \text{co}\}$, $\sigma^t\text{-t-NSA}$ is coNP-hard and in Π_2^P , it is trivial for $\sigma = \text{ad}$, it is coNP-complete for $\sigma = \text{gr}$, and it is Π_2^P -hard and in Π_3^P for $\sigma = \text{pr}$.
- For $\sigma \in \{\text{ad}, \text{st}, \text{co}\}$, $\sigma^t\text{-t-NCA}$ is Π_2^P -complete, it is coNP-complete for $\sigma = \text{gr}$, and it is Π_2^P -hard and in Π_3^P for $\sigma = \text{pr}$.
- For $\sigma = \text{gr}$, $\sigma^t\text{-t-PSA}$ is NP-complete, it is trivial for $\sigma = \text{ad}$, NP-hard and in Σ_2^P for $\sigma = \text{co}$, it is Σ_2^P -complete for $\sigma = \text{st}$, and Σ_3^P -complete for $\sigma = \text{pr}$.

Proof: We start with $\sigma^t\text{-t-PCA}$. For the upper bound, for $\sigma \in \{\text{gr}, \text{ad}, \text{st}, \text{co}\}$, given \mathcal{IB} and a ,

1. Guess a completion \mathcal{B}^* and a set of arguments S s.t. $a \in S$
2. Check whether \mathcal{B}^* is a t-completion
3. Check whether S is a σ -extension of \mathcal{B}^*

For $\sigma \in \{\text{ad}, \text{co}, \text{st}\}$, step 2 is a call to a coNP oracle, and step 3 is doable in polynomial time, so $\sigma^t\text{-t-PCA}$ is in Σ_2^P . For $\sigma = \text{gr}$, steps 2 and 3 are doable in polynomial time, so $\text{gr}^t\text{-t-PCA}$ is in NP. Finally, for $\sigma = \text{pr}$, notice that the argument a belongs to some preferred extension of some completion of \mathcal{IB} iff a belongs to some admissible set of some completion, hence the result.

For the lower bound, $\sigma\text{-PCA}$ is NP-hard for all considered semantics in the case of IAFs [35], so it is NP-hard for IBAFs as well.

Then, we consider $\sigma^t\text{-t-NSA}$. As usual, lower bound can be obtained from the complexity of the corresponding problem for IAFs [35].

For the upper bound, for $\sigma \in \{\text{co}, \text{gr}\}$, we can solve the complementary problem by:

1. guessing a completion \mathcal{B}^*
2. checking whether it is a “valid” semantic completion, in polynomial time for $\sigma = \text{gr}$, in coNP for $\sigma = \text{co}$ (see Prop. 5),
3. checking if a is *not* skeptically accepted in \mathcal{B}^*

So the complementary problem is in NP for gr , and in Σ_2^P for co . For $\sigma \in \{\text{st}, \text{pr}\}$, the algorithm for the complementary problem is:

1. guess a completion \mathcal{B}^* and a set of arguments S *not* containing the query argument,
2. check whether it is a “valid” semantic completion, in coNP for st and in Π_2^P for pr ,
3. check if S is an extension, in polynomial time for st and in coNP for pr .

This means that the complementary problem is in Σ_2^P for st , and in Σ_3^P for pr .

Now, let us show the results for $\sigma^t\text{-t-NCA}$. Hardness results follow known complexity for IAFs [35]. For the upper bound, we solve the complementary problem as follows for the grounded semantics:

1. Guess a completion \mathcal{B}^*
2. Check in polynomial time that it is a “valid” semantic completion
3. Check in polynomial time that the query argument is not accepted.

So the complementary problem is in NP for *gr*.

For the other semantics, the non-deterministic algorithm is the same, but checking if the completion is valid is **coNP**-complete (for $\sigma \in \{\text{ad}, \text{co}, \text{st}\}$) or Π_2^P -complete (for $\sigma = \text{pr}$), and credulous acceptability is NP-complete in all these cases. So we obtain Σ_2^P membership for the first three semantics, and Σ_3^P membership for the preferred semantics.

Finally, we prove the results for σ^t -t-PSA. Lower bounds are provided by known results for IAFs [35]. Upper bounds can be obtained by a classical non-deterministic algorithms:

1. Guess a completion \mathcal{B}^* of \mathcal{IB} ,
2. Check (in polynomial time for *gr*, in **coNP** for $\{\text{co}, \text{st}\}$, and Π_2^P for *pr*) if \mathcal{B}^* is a valid semantic completion,
3. Check (in polynomial time for $\{\text{gr}, \text{co}\}$, in **coNP** for *st*, in Π_2^P for *pr*) if the query argument is skeptically accepted in \mathcal{B}^* .

This means that we have a NP algorithm for $\sigma = \text{gr}$, Σ_2^P for $\sigma \in \{\text{co}, \text{st}\}$, and Σ_3^P for $\sigma = \text{pr}$. \square

Observation 1. Let $\mathcal{IB} = \langle \mathcal{A}, \mathcal{A}^?, \mathcal{R}, \mathcal{R}^?, \mathcal{S}, \mathcal{S}^? \rangle$ be an IBAF, and $\mathcal{B}^* = \langle \mathcal{A}^*, \mathcal{R}^*, \mathcal{S}^* \rangle$. Checking whether $\mathcal{B}^* \in \text{completions}^{\text{ct}}(\mathcal{IB})$ (for $\text{t} \in \{\text{ded}, \text{nec}\}$) can be done in polynomial time (w.r.t. the number of arguments $|\mathcal{A} \cup \mathcal{A}^?|$).

Proof: Given \mathcal{IB} and \mathcal{B}^* , simply iterate over the set of pairs of arguments $(a, b) \in (\mathcal{A} \cup \mathcal{A}^?) \times (\mathcal{A} \cup \mathcal{A}^?)$. We consider deductive (respectively necessary) support. If $(a, b) \in \mathcal{S}$, $a \in \mathcal{A}^*$ (respectively $b \in \mathcal{A}^*$), and $b \notin \mathcal{A}^*$ (respectively $a \notin \mathcal{A}^*$), then \mathcal{B}^* is not closed under deductive (respectively necessary) support. If no such pair (a, b) is found, then \mathcal{B}^* is a closed completion. \square

Proposition 7 For $\text{t} \in \{\text{nec}, \text{ded}\}$ the following complexity results hold:

- For $\sigma \in \{\text{ad}, \text{gr}, \text{st}, \text{co}, \text{pr}\}$, σ^t -ct-PCA is NP-complete.
- For $\sigma \in \{\text{gr}, \text{st}, \text{co}\}$, σ^t -ct-NSA is **coNP**-complete, it is trivial for $\sigma = \text{ad}$, and it is Π_2^P -complete for $\sigma = \text{pr}$.
- For $\sigma \in \{\text{ad}, \text{st}, \text{co}, \text{pr}\}$, σ^t -ct-NCA is Π_2^P -complete, and it is **coNP**-complete for $\sigma = \text{gr}$.
- For $\sigma \in \{\text{co}, \text{gr}\}$, σ^t -ct-PSA is NP-complete, it is trivial for $\sigma = \text{ad}$, it is Σ_2^P -complete for $\sigma = \text{st}$, and Σ_3^P -complete for $\sigma = \text{pr}$.

Proof: We start with σ^t -ct-PCA. NP-hardness comes from the NP-hardness of σ -PCA for (non-bipolar) IAFs [35] for all these semantics. Then, for $\sigma \in \{\text{ad}, \text{gr}, \text{st}, \text{co}\}$, the problem can be solved by a classical non-deterministic algorithm: guess a completion $\mathcal{B}^* = \langle \mathcal{A}^*, \mathcal{R}^*, \mathcal{S}^* \rangle$ of

\mathcal{IB} and a set of arguments $S \subseteq \mathcal{A}^*$ such that the queried argument a is in S . Check in polynomial time whether \mathcal{B}^* is closed under the type of support, then check in polynomial time whether S is a σ -extension of \mathcal{B}^* . Hence the NP-membership for these semantics. Finally, as usual, credulous acceptability under the preferred semantics coincides with the credulous acceptability under admissible and complete semantics, so we obtain the result for the last semantics.

Then, for σ^t -ct-NSA, similarly to the previous case, lower bounds are provided by the complexity of σ -NSA for IAFs [35]. So we focus on the upper bounds and show that they coincide. We consider the complementary problem $\overline{\text{NSA}}$, which can be solved by a non-deterministic algorithm similar to the one used in the previous case: non-deterministically guess a completion \mathcal{B}^* of \mathcal{IB} and a set of arguments *not* containing the queried argument. Check in polynomial time if \mathcal{B}^* is closed under the fixed type of support, then check in polynomial time (for $\sigma \in \{\text{gr}, \text{st}, \text{co}\}$) or in coNP (for $\sigma = \text{pr}$) whether the set of arguments is an extension. So, the complementary problem is in NP for the first three semantics, and in Σ_2^P for the preferred semantics, hence the result.

Now, focusing on σ^t -ct-NCA, the lower bounds are again provided by the complexity of σ -NCA for IAFs [35]. For the upper bound, we consider the complementary problem $\overline{\text{NCA}}$, which is solved by non-deterministically guessing a completion \mathcal{B}^* , then checking (in polynomial time) if \mathcal{B}^* is a support-closed completion for \mathbf{t} , and finally checking if the queried argument is *not* credulously accepted. Credulous acceptability in BAFs is in P for the grounded semantics, and in NP for the other semantics under consideration, so $\overline{\text{NCA}}$ is in NP in the former case, and in Σ_2^P in the latter case, hence the result.

Finally, for σ^t -ct-PSA, we obtain again hardness results from the hardness of the corresponding problems for IAFs [35]. Then, we can solve the problem by guessing a completion \mathcal{B}^* , checking (in polynomial time) that it is closed under \mathbf{t} , and finally checking if the queried argument is sceptically acceptable in \mathcal{B}^* . This last check is polynomial for $\sigma \in \{\text{gr}, \text{co}\}$, in coNP for $\sigma = \text{st}$, and in Π_2^P for $\sigma = \text{pr}$, so we can deduce the result. \square

A.4 Proofs for Section 5

Proposition 8 Let $\mathcal{B} = \langle \mathcal{A}, \mathcal{R}, \mathcal{S} \rangle$ be a BAF, let $\mathbf{t} \in \{\text{nec}, \text{ded}\}$, and let σ be an argumentation semantics, we have that

$$\sigma^t(\mathcal{B}) = \{E_{v'} \mid (v_{\mathcal{B}}, v') \in \|\text{addAttacks}^{\mathbf{t}}; \text{mkExt}^{\sigma}\|\}.$$

Proof: As preliminary steps, one has to show the correctness of the involved programs and formulas. In particular, let $v \subseteq \text{Prp}$ be a valuation and let $\langle \mathcal{A}_v, \mathcal{R}_v, \mathcal{S}_v \rangle$ be the BAF represented by v , it holds that:

- If $(v, v') \in \|\text{transClosure}\|$, then $\mathcal{S}_v^+ = \mathcal{S}_{v'}$.
- $v \models (\mathbf{r}_{x,y}^{\text{aw}} \vee \mathbf{r}_{x,y}^{\text{case1}} \vee \mathbf{r}_{x,y}^{\text{case2}})$ iff $(x, y) \in \mathcal{R}_v^{\text{ded}}$.
- If $(v, v') \in \|\text{addAttacks}^{\text{ded}}\|$, then $\mathcal{R}_v^{\text{ded}} = \mathcal{R}_{v'}$.

- If $(v, v') \in \|\text{necessary2deductive}\|$, then $\mathcal{R}_v^{-1} = \mathcal{R}_{v'}$.
- If $(v, v') \in \|\text{addAttacks}^{\text{nec}}\|$, then $\mathcal{R}_v^{\text{nec}} = \mathcal{R}_{v'}$.

The proofs of these lemmas are left to the reader. Then, the claim of the proposition follows from the last three bullet points, and the correctness of mkExt for our target semantics $\{\text{co}, \text{st}, \text{gr}, \text{pr}\}$ (see, e.g., [45, Theorem 1]). \square

Proposition 9 Let $\mathcal{IB} = \langle \mathcal{A}, \mathcal{A}^?, \mathcal{R}, \mathcal{R}^?, \mathcal{S}, \mathcal{S}^? \rangle$, $\text{t} \in \{\text{pla}, \text{nec}, \text{ded}, \text{cnec}, \text{cded}\}$, and let σ be a semantics. Then:

- If $\langle v_{\mathcal{IB}}, v \rangle \in \|\text{mkComp}_\sigma^{\text{t}}(\mathcal{IB})\|$, then $\langle \mathcal{A}_v, \mathcal{R}_v, \mathcal{S}_v \rangle \in \text{completions}_\sigma^{\text{t}}(\mathcal{IB})$.
- If $\langle \mathcal{A}_c, \mathcal{R}_c, \mathcal{S}_c \rangle \in \text{completions}_\sigma^{\text{t}}(\mathcal{IB})$, then there is a $v \subseteq \text{Prp}$ s.t. $v \cap \text{Prp}_{\mathbf{A}} = v_{\langle \mathcal{A}_c, \mathcal{R}_c, \mathcal{S}_c \rangle}$ and $\langle v_{\mathcal{IB}}, v \rangle \in \|\text{mkComp}_\sigma^{\text{t}}(\mathcal{IB})\|$.

Proof: We prove both items for each possible value of t .

[$\text{t} = \text{pla}$] **For the first item**, suppose $\langle v_{\mathcal{IB}}, v \rangle \in \|\text{mkComp}_\sigma^{\text{pla}}(\mathcal{IB})\|$. By the definition of $\text{mkComp}_\sigma^{\text{pla}}(\mathcal{IB})$ and the meaning of mkTrueSome , we have that $v = v_{\mathcal{IB}} \cup \text{AW}_{\mathcal{A}'} \cup \text{ATT}_{\mathcal{R}'} \cup \text{SUP}_{\mathcal{S}'}$ with $\mathcal{A}' \subseteq \mathcal{A}^?$, $\mathcal{R}' \subseteq \mathcal{R}^?$ and $\mathcal{S}' \subseteq \mathcal{S}^?$. The latter implies, by definition of $(\cdot)_v$ that $\mathcal{A}_v = \mathcal{A} \cup \mathcal{A}'$, $\mathcal{R}_v = \mathcal{R} \cup \mathcal{R}'$ and $\mathcal{S}_v = \mathcal{S} \cup \mathcal{S}'$. The last two claims imply, by Definition 2, that $\langle \mathcal{A}_v, \mathcal{R}_v, \mathcal{S}_v \rangle \in \text{completions}_\sigma^{\text{pla}}(\mathcal{IB})$.

For the second item, the valuation that satisfies the existential claim is simply $v_{\langle \mathcal{A}_c, \mathcal{R}_c, \mathcal{S}_c \rangle}$. Let us show it. Suppose that $\langle \mathcal{A}_c, \mathcal{R}_c, \mathcal{S}_c \rangle \in \text{completions}_\sigma^{\text{pla}}(\mathcal{IB})$, which amounts, by Definition 2, to $\mathcal{A} \subseteq \mathcal{A}_c \subseteq \mathcal{A} \cup \mathcal{A}^?$; $\mathcal{R} \cap (\mathcal{A}_c \times \mathcal{A}_c) \subseteq \mathcal{R}_c \subseteq (\mathcal{R} \cup \mathcal{R}^?) \cap (\mathcal{A}_c \times \mathcal{A}_c)$ and $\mathcal{S} \cap (\mathcal{A}_c \times \mathcal{A}_c) \subseteq \mathcal{S}_c \subseteq (\mathcal{S} \cup \mathcal{S}^?) \cap (\mathcal{A}_c \times \mathcal{A}_c)$. Now, recall that $v_{\mathcal{IB}} = v_{\langle \mathcal{A}, \mathcal{R}, \mathcal{S} \rangle}$. From the two previous statements we can deduce that the set of variables whose value differs from $v_{\mathcal{IB}}$ to $v_{\langle \mathcal{A}_c, \mathcal{R}_c, \mathcal{S}_c \rangle}$ must be a subset of $\text{AW}_{\mathcal{A}'} \cup \text{ATT}_{\mathcal{R}'} \cup \text{SUP}_{\mathcal{S}'}$. The latter implies, by the definition of $\text{mkComp}_\sigma^{\text{pla}}$ and the meaning of mkTrueSome that $\langle v_{\mathcal{IB}}, v_{\langle \mathcal{A}_c, \mathcal{R}_c, \mathcal{S}_c \rangle} \rangle \in \|\text{mkComp}_\sigma^{\text{pla}}(\mathcal{IB})\|$.

[$\text{t} = \text{ded}$] **For the first item**, suppose $\langle v_{\mathcal{IB}}, v \rangle \in \|\text{mkComp}_\sigma^{\text{ded}}(\mathcal{IB})\|$, which amounts by definition of $\text{mkComp}_\sigma^{\text{ded}}$ and the semantics of the sequential composition operator to $\langle v_{\mathcal{IB}}, v \rangle \in$

$$\|\text{copy}''(\text{SUP}_{\mathbf{A} \times \mathbf{A}})\| \circ \|\text{mkComp}_\sigma^{\text{pla}}(\mathcal{IB})\| \circ \|\text{([addAttacks}^{\text{ded}}; \text{mkExt}^\sigma] \text{Constraint}^{\text{ded}})?\|.$$

That means that there are $v_1, v_2 \subseteq \text{Prp}$ s.t.

- (1) $\langle v_{\mathcal{IB}}, v_1 \rangle \in \|\text{copy}''(\text{SUP}_{\mathbf{A} \times \mathbf{A}})\|$,
- (2) $\langle v_1, v_2 \rangle \in \|\text{mkComp}_\sigma^{\text{pla}}(\mathcal{IB})\|$, and
- (3) $\langle v_2, v \rangle \in \|\text{([addAttacks}^{\text{ded}}; \text{mkExt}^\sigma] \text{Constraint}^{\text{ded}})?\|$.

On the one hand, and since the execution of $\text{copy}''(\text{SUP}_{\mathbf{A} \times \mathbf{A}})$ does not alter the value of any variable from $\text{Prp}_{\mathbf{A}}$, we can deduce from (1), (2) and the previous case of this proposition that $\langle \mathcal{A}_{v_2}, \mathcal{R}_{v_2}, \mathcal{S}_{v_2} \rangle \in$

completions^{pla}(\mathcal{IB}). Moreover, note that by the semantics of ‘?’, we can deduce from (3) that $v_2 = v$. Substituting identical terms we have that $\langle \mathcal{A}_v, \mathcal{R}_v, \mathcal{S}_v \rangle \in \text{completions}^{\text{pla}}(\mathcal{IB})$. So we’ve shown that the first part of the definition of deductive completion is satisfied by $\langle \mathcal{A}_v, \mathcal{R}_v, \mathcal{S}_v \rangle$.

On the other hand, suppose that $E \in \sigma^{\text{ded}}(\langle \mathcal{A}_v, \mathcal{R}_v, \mathcal{S}_v \rangle)$. The latter implies, by Proposition 8, that $E = E_{v_4}$ for some $\langle v, v_4 \rangle \in \|\text{addAttacks}^{\text{ded}}; \text{mkExt}^\sigma\|$. Note that from (3), the truth clause of $[\pi]$, and the previous assertion we can deduce that $v_4 \models \text{Constraint}^{\text{ded}}$. Suppose that $(x, y) \in \mathcal{S}$ (recall that \mathcal{S} is the set of certain supports), which implies $\mathbf{s}_{x,y} \in v_{\mathcal{IB}}$, which in turn implies, by the definition of copy'' and the rest of involved programs, that $\mathbf{s}'_{x,y} \in v_4$. Further, suppose that $x \in E = E_{v_4}$. Both facts, together with $v_4 \models \text{Constraint}^{\text{ded}}$ imply that $y \in E_{v_4} = E$. So we’ve shown that the second part of the definition of deductive completion is satisfied by $\langle \mathcal{A}_v, \mathcal{R}_v, \mathcal{S}_v \rangle$. We can then assert that $\langle \mathcal{A}_v, \mathcal{R}_v, \mathcal{S}_v \rangle \in \text{completions}^{\text{ded}}(\mathcal{IB})$.

For the second item, the valuation witnessing the existential claim is $v = v_{\langle \mathcal{A}_c, \mathcal{R}_c, \mathcal{S}_c \rangle} \cup \{\mathbf{s}''_{x,y} \mid (x, y) \in \mathcal{S}\}$. Let us show it. Suppose that $\langle \mathcal{A}_c, \mathcal{R}_c, \mathcal{S}_c \rangle \in \text{completions}_\sigma^{\text{ded}}(\mathcal{IB})$, which by Def. 2 amounts to:

- (1) $\langle \mathcal{A}_c, \mathcal{R}_c, \mathcal{S}_c \rangle \in \text{completions}_\sigma^{\text{pla}}(\mathcal{IB})$; and
- (2) $\forall E \in \sigma^{\text{ded}}(\langle \mathcal{A}_c, \mathcal{R}_c, \mathcal{S}_c \rangle), \forall (x, y) \in \mathcal{S}$ if $x \in E$, then $y \in E$.

Now, let $v_1 = v_{\mathcal{IB}} \cup \{\mathbf{s}''_{x,y} \mid (x, y) \in \mathcal{S}\}$, we have that $\langle v_{\mathcal{IB}}, v_1 \rangle \in \|\text{copy}''(\text{IN}_{\mathbf{A}})\|$ by definition of copy . Moreover, let $v_2 = v_{\langle \mathcal{A}_c, \mathcal{R}_c, \mathcal{S}_c \rangle} \cup \{\mathbf{s}''_{x,y} \mid (x, y) \in \mathcal{S}\}$, we can deduce that $\langle v_1, v_2 \rangle \in \|\text{mkComp}^{\text{pla}}(\mathcal{IB})\|$ from (1), the previous case of this proof (i.e., $\mathbf{t} = \text{pla}$), and the fact that $\text{mkComp}^{\text{pla}}$ does not alter the value of $\mathbf{s}''_{x,y}$ -variables.

Finally, note that v_2 “survives” to the test $([\text{addAttacks}^{\text{nec}}; \text{mkExt}^\sigma] \text{Constraint}^{\text{ded}})$? because of (2) and Proposition 8.

[$\mathbf{t} = \text{nec}$] This case is very similar to the previous one. The only important detail is the use of fresh variables $\{\mathbf{s}''_{x,y} \mid (x, y) \in \mathbf{A} \times \mathbf{A}\}$ instead of $\{\mathbf{s}'_{x,y} \mid (x, y) \in \mathbf{A} \times \mathbf{A}\}$ by the program copy'' , so that the execution of $\text{necessary2deductive}$ does not affect the evaluation of $\text{Constraint}^{\text{nec}}$.

[$\mathbf{t} = \text{cded}, \mathbf{t} = \text{cnec}$] Since the constraints for closed completions are merely syntactic, the proofs of these two cases are just simplified versions of the previous two cases. □

Proposition 10 Let $\mathcal{IB} = \langle \mathcal{A}, \mathcal{A}^?, \mathcal{R}, \mathcal{R}^?, \mathcal{S}, \mathcal{S}^? \rangle$, let $a \in \mathcal{A}$, let $\sigma \in \{\text{co}, \text{pr}, \text{gr}, \text{st}\}$, let $\mathbf{t}_1 \in \{\text{pla}, \text{nec}, \text{ded}, \text{cnec}, \text{cded}\}$ and $\mathbf{t}_2 \in \{\text{nec}, \text{ded}\}$ s.t. if $\mathbf{t}_1 \in \{\text{nec}, \text{ded}\}$, then $\mathbf{t}_1 = \mathbf{t}_2$; and if $\mathbf{t}_1 \in \{\text{cnec}, \text{cded}\}$, then $\mathbf{t}_1 = \mathbf{ct}_2$. Then:

- The answer to $\sigma^{\mathbf{t}_2}$ - \mathbf{t}_1 -PCA with input \mathcal{IB} and a is YES iff $v_{\mathcal{IB}} \models \langle \text{mkComp}_{\sigma}^{\mathbf{t}_1}(\mathcal{IB}); \text{addAttacks}^{\mathbf{t}_2}; \text{mkExt}^\sigma \rangle \text{in}_a$.

- The answer to $\sigma^{t_2}\text{-t}_1\text{-NCA}$ with input \mathcal{IB} and a is YES iff $v_{\mathcal{IB}} \models [\text{mkComp}_\sigma^{t_1}(\mathcal{IB})] \langle \text{addAttacks}^{t_2}; \text{mkExt}^\sigma \rangle \text{in}_a$.
- The answer to $\sigma^{t_2}\text{-t}_1\text{-PSA}$ with input \mathcal{IB} and a is YES iff $v_{\mathcal{IB}} \models \langle \text{mkComp}_\sigma^{t_1}(\mathcal{IB}) \rangle [\text{addAttacks}^{t_2}; \text{mkExt}^\sigma] \text{in}_a$.
- The answer to $\sigma^{t_2}\text{-t}_1\text{-NSA}$ with input \mathcal{IB} and a is YES iff $v_{\mathcal{IB}} \models [\text{mkComp}_\sigma^{t_1}(\mathcal{IB}); \text{addAttacks}^{t_2}; \text{mkExt}^\sigma] \text{in}_a$.

Proof: All cases follow similar lines of reasoning, using propositions 8 and 9 in the crucial steps. More precisely, some of the cases need a stronger version of Proposition 8 that is easily derivable from the meaning of the involved DL-PA programs. Namely, that the claim works not only for $v_{\mathcal{B}}$ but for any other valuation that agrees with it in the value given to variables in $\text{Prp} \cup \text{ATT}'_{\mathbf{A} \times \mathbf{A}} \cup \text{SUP}'_{\mathbf{A} \times \mathbf{A}}$ where $\text{ATT}'_{\mathbf{A} \times \mathbf{A}} = \{\mathbf{r}'_{x,y} \mid (x,y) \in \mathbf{A} \times \mathbf{A}\}$, and the same for supports. More formally, we have that:

$$\begin{aligned} \sigma^t(\mathcal{B}) = & \{E_{v'} \mid (v, v') \in \|\text{addAttacks}^t; \text{mkExt}^\sigma\|, \\ & v \cap (\text{Prp}_{\mathbf{A}} \cup \text{ATT}'_{\mathbf{A} \times \mathbf{A}} \cup \text{SUP}'_{\mathbf{A} \times \mathbf{A}}) = v_{\mathcal{B}}\}. \end{aligned} \quad (1)$$

Let us just see the proof for the first reasoning problem as an illustration: $[\sigma^{t_2}\text{-t}_1\text{-PCA}]$ **From-left-to-right.** Suppose that the answer to the reasoning problem is YES. The latter is equivalent, by definition of $\sigma^{t_2}\text{-t}_1\text{-PCA}$, to:

$\exists \mathcal{B} \in \text{completions}_\sigma^{t_1}(\mathcal{IB}), \exists E \in \sigma^{t_2}(\mathcal{B})$ s.t. $a \in E$. This implies, by the proof of the second bullet of Proposition 9 that:

$\exists \mathcal{B}$ a BAF s.t. the valuation $v = v_{\mathcal{B}} \cup \{\mathbf{s}''_{x,y} \mid (x,y) \in \mathcal{S}\}$ satisfies $\langle v_{\mathcal{IB}}, v \rangle \in \|\text{mkComp}_\sigma^{t_1}(\mathcal{IB})\|, \exists E \in \sigma^{t_2}(\mathcal{B}), a \in E$. From this statement and (1) we can deduce that:

$$\begin{aligned} \exists v \subseteq \text{Prp} \text{ s.t. } \langle v_{\mathcal{IB}}, v \rangle & \in \|\text{mkComp}_\sigma^{t_1}(\mathcal{IB})\|, \\ \exists v' \subseteq \text{Prp}, \langle v, v' \rangle & \in \|\text{addAttacks}^{t_2}; \text{mkExt}^\sigma\| \text{ with } v' \models \text{in}_a. \end{aligned}$$

This implies, by the semantics of $\langle \pi \rangle$ and the semantics of $;$ that:

$$v_{\mathcal{IB}} \models \langle \text{mkComp}_\sigma^{t_1}(\mathcal{IB}); \text{addAttacks}^{t_2}; \text{mkExt}^\sigma \rangle \text{in}_a.$$

From-right-to-left. Suppose that

$v_{\mathcal{IB}} \models \langle \text{mkComp}_\sigma^{t_1}(\mathcal{IB}); \text{addAttacks}^{t_2}; \text{mkExt}^\sigma \rangle \text{in}_a$. This implies, by the meaning of $\langle \pi \rangle$ and $;$ that:

$$\begin{aligned} \exists v \subseteq \text{Prp} \text{ s.t. } \langle v_{\mathcal{IB}}, v \rangle & \in \|\text{mkComp}_\sigma^{t_1}(\mathcal{IB})\|, \\ \exists v' \subseteq \text{Prp}, \langle v, v' \rangle & \in \|\text{addAttacks}^{t_2}; \text{mkExt}^\sigma\| \text{ with } a \in E_{v'}. \end{aligned}$$

This implies by the first bullet of Proposition 9 that:

$$\begin{aligned} \exists v \subseteq \text{Prp} \text{ s.t. } \langle \mathcal{A}_v, \mathcal{R}_v, \mathcal{S}_v \rangle & \in \text{completions}_\sigma^{t_1}(\mathcal{IB}), \\ \exists v' \subseteq \text{Prp}, \langle v, v' \rangle & \in \|\text{addAttacks}^{t_2}; \text{mkExt}^\sigma\| \text{ with } a \in E_{v'}. \end{aligned}$$

This implies by Proposition 8 that:

$$\begin{aligned} \exists v \subseteq \text{Prp} \text{ s.t. } \langle \mathcal{A}_v, \mathcal{R}_v, \mathcal{S}_v \rangle & \in \text{completions}_\sigma^{t_1}(\mathcal{IB}), \\ \exists v' \subseteq \text{Prp}, E_{v'} \in \sigma^{t_2}(\langle \mathcal{A}_v, \mathcal{R}_v, \mathcal{S}_v \rangle) & \text{ and } a \in E_{v'}. \end{aligned}$$

This implies by definition of $\sigma^{t_2}\text{-t}_1\text{-PCA}$ that:

The answer to $\sigma^{t_2}\text{-t}_1\text{-PCA}$ is YES. □