



HAL
open science

Genome-Wide Analysis of the AP2/ERF Family in *Eucalyptus grandis*: An Intriguing Over-Representation of Stress-Responsive DREB1/CBF Genes

Phi Bang Cao, Sahar Azar, H el ene San Clemente, Fabien Mounet, Christophe Dunand, Guillaume Marque, Christiane Marque, Chantal Teuli eres

► **To cite this version:**

Phi Bang Cao, Sahar Azar, H el ene San Clemente, Fabien Mounet, Christophe Dunand, et al.. Genome-Wide Analysis of the AP2/ERF Family in *Eucalyptus grandis*: An Intriguing Over-Representation of Stress-Responsive DREB1/CBF Genes. PLoS ONE, 2015, 10 (4), pp.e0121041. 10.1371/journal.pone.0121041 . hal-03615136

HAL Id: hal-03615136

<https://ut3-toulouseinp.hal.science/hal-03615136>

Submitted on 21 Mar 2022

HAL is a multi-disciplinary open access archive for the deposit and dissemination of scientific research documents, whether they are published or not. The documents may come from teaching and research institutions in France or abroad, or from public or private research centers.

L'archive ouverte pluridisciplinaire **HAL**, est destin ee au d ep ot et  a la diffusion de documents scientifiques de niveau recherche, publi es ou non,  emanant des  tablissements d'enseignement et de recherche fran ais ou  trangers, des laboratoires publics ou priv es.



Distributed under a Creative Commons Attribution 4.0 International License

RESEARCH ARTICLE

Genome-Wide Analysis of the AP2/ERF Family in *Eucalyptus grandis*: An Intriguing Over-Representation of Stress-Responsive *DREB1/CBF* Genes

P. B. Cao^{1,2}[✉][¶], S. Azar^{1,2}[¶][¶], H. SanClemente^{1,2}, F. Mounet^{1,2}, C. Dunand^{1,2}, G. Marque^{1,2}, C. Marque^{1,2}, C. Teulieres^{1,2}^{*}

1 Université de Toulouse, UPS, UMR 5546, LRSV, 24 Chemin de Borde Rouge, Auzeville, BP 42617 31326, Castanet-Tolosan, France, **2** CNRS, UMR 5546, LRSV, 24 Chemin de Borde Rouge, Auzeville, BP 42617 31326, Castanet-Tolosan, France

✉ These authors contributed equally to this work.

¶ Current address: Hung Vuong University, Trường đại học Hùng Vương, Phường Hùng Vương, Thị xã Phú Thọ, Tỉnh Phú Thọ, Vietnam

¶ Current address: Lebanese University, Faculty of Sciences II, Department of Biology. Fanar—Matn, Lebanon

* teulieres@lrsv.ups-tlse.fr



OPEN ACCESS

Citation: Cao PB, Azar S, SanClemente H, Mounet F, Dunand C, Marque G, et al. (2015) Genome-Wide Analysis of the AP2/ERF Family in *Eucalyptus grandis*: An Intriguing Over-Representation of Stress-Responsive *DREB1/CBF* Genes. PLoS ONE 10(4): e0121041. doi:10.1371/journal.pone.0121041

Academic Editor: Zhulong Chan, Chinese Academy of Sciences, CHINA

Received: December 10, 2014

Accepted: February 11, 2015

Published: April 7, 2015

Copyright: © 2015 Cao et al. This is an open access article distributed under the terms of the [Creative Commons Attribution License](https://creativecommons.org/licenses/by/4.0/), which permits unrestricted use, distribution, and reproduction in any medium, provided the original author and source are credited.

Data Availability Statement: All relevant data are within the paper and its supporting information files, accession numbers and genome location on genomic sequence (Phytozome database).

Funding: This work was funded by Fibre Excellence (31, St Gaudens, France) associated with the Midi Pyrénées Regional Council (France) and also supported by the French Ministry for Scientific Research (University Toulouse III (UPS), CNRS and Labex Tulip (ANR-10-LABX-41); the Vietnamese Government provided the PBC grant. The funders had no role in study design, data collection and

Abstract

Background

The AP2/ERF family includes a large number of developmentally and physiologically important transcription factors sharing an AP2 DNA-binding domain. Among them *DREB1/CBF* and *DREB2* factors are known as master regulators respectively of cold and heat/osmotic stress responses.

Experimental Approaches

The manual annotation of AP2/ERF family from *Eucalyptus grandis*, *Malus*, *Populus* and *Vitis* genomes allowed a complete phylogenetic study for comparing the structure of this family in woody species and the model *Arabidopsis thaliana*. Expression profiles of the whole groups of *EgrDREB1* and *EgrDREB2* were investigated through RNAseq database survey and RT-qPCR analyses.

Results

The structure and the size of the AP2/ERF family show a global conservation for the plant species under comparison. In addition to an expansion of the ERF subfamily, the tree genomes mainly differ with respect to the group representation within the subfamilies. With regard to the *E. grandis* *DREB* subfamily, an obvious feature is the presence of 17 *DREB1/CBF* genes, the maximum reported to date for dicotyledons. In contrast, only six *DREB2* have been identified, which is similar to the other plants species under study, except for *Malus*. All the *DREB1/CBF* and *DREB2* genes from *E. grandis* are expressed in at least one

analysis, decision to publish, or preparation of the manuscript.

Competing Interests: The authors received funding from Fibre Excellence, a commercial company, for this study. This does not alter the authors' adherence to all the PLOS ONE policies on sharing data and materials.

condition and all are heat-responsive. Regulation by cold and drought depends on the genes but is not specific of one group; DREB1/CBF group is more cold-inducible than DREB2 which is mainly drought responsive.

Conclusion

These features suggest that the dramatic expansion of the *DREB1/CBF* group might be related to the adaptation of this evergreen tree to climate changes when it expanded in Australia.

Introduction

Native to Australia, *Eucalyptus* tree species are among the fastest growing woody plants in the world and represent about 8% of all planted forest with over 18 million hectares grown in 90 countries [1]. Over the last few decades, *Eucalyptus* trees became one of the main wood fiber crops and a cost-effective source of lignocellulosic biomass for energy production. Market favorites for pulpwood are *E. grandis*, *E. urophylla* and their hybrids, grown in tropical and subtropical regions, and *E. globulus*, planted in temperate regions. Frost tolerance is limiting their expansion in temperate climates, such as in Southern Europe or Southeastern USA [2]. Being evergreen and evergrowing, the *Eucalyptus* trees are exposed to cold while growing and all the organs may have to cope with frost.

The 605 Mb *E. grandis* genome sequence released in January 2011 including about 96% of the expressed gene loci [3] now allows genome-wide investigations. In the present study, this resource was surveyed to manually annotate the AP2/ERF (APETALA2/Ethylene-Responsive element binding Factor) family which is characterized by a highly conserved AP2-DNA binding domain [4, 5]. This transcription factor family is known to play a key role in various developmental and adaptive processes in plants, in particular through biotic and abiotic stress response [6, 7]. Ranging between 132 and 292 genes, this family is one of the largest groups of transcription factors [8, 9] and has been classified into subfamilies [10]. The AP2 subfamily contains proteins exhibiting two AP2/ERF domains and known to be involved in the regulation of developmental processes [11–13]. The RAV (Related to ABI3/VP1) proteins which contain two different DNA-binding domains (AP2/ERF and B3) are regulated by ethylene [14] or brassinosteroids [15] and also contribute to biotic and abiotic stress responses [16]. Exhibiting only one AP2/ERF domain, the ERF and DREB (Dehydration Responsive Element Binding) proteins are key regulators of plant responses to biotic and abiotic stresses [17, 18]. The ERF subfamily includes a large number of proteins binding to the GCC box [19], an ethylene responsive element located in the promoter of pathogenesis-related genes [20]. The DREB factors which recognize the cis-acting sequences CRT (C-Repeat) or DRE (Dehydration Responsive Element) located in the promoters of abiotic stress responsive genes [10]. The DREB subfamily has been divided into six groups (A1–A6) which includes the A1 and A2 groups, commonly known as *DREB1/CBF* and *DREB2* [10]. The *DREB1/CBF* genes are mainly known as cold-responsive whereas most of the *DREB2* genes have generally been reported as responsive to water stress or heat-shock. However, there is a growing evidence that the stress regulation of *DREB1/CBF* and *DREB2* genes differs according to the plant species [6, 7], [21], [22, 23]. The demonstration of a functional role of *Eucalyptus* CBF genes in abiotic stress tolerance was achieved in our hands through overexpression in the hybrid *E. urophylla* x *E. grandis* [24]

For the first time, the paper presents a comparison of phylogenetic structure of AP2/ERF families based on manually annotated sequences from four woody plants (*Eucalyptus*, *Populus*, *Malus* and *Vitis*) and *Arabidopsis*. Since the number of CBF gene copies was found to be genetically related to stress tolerance [25], the present study may provide new information on the distinct evolution of these species to cope with different environments. The second part of this paper focuses on the DREB1/CBF and DREB2 which are the most described groups with regard to stress response. Interestingly, the comparison of DREB groups from woody species reveals an over-representation of DREB1/CBF members in *E. grandis* genome, together with a moderate number of DREB2 genes. In addition, gene expression of all the members of DREB1/CBF and DREB2 groups in response to various stresses or in different tissues is presented. The data, which raise the question about specificity of these groups in stress response (cold/heat/drought), are discussed in the context of the adaptive evolution of *Eucalyptus*.

Materials and Methods

Source of genome databases

The annotated *E. grandis* genome sequence (V1.1) is available at Phytozome website (<http://www.phytozome.net/eucalyptus.php>). The genomic sequences of *A. thaliana* AP2/ERF family were down-loaded from the DATF (Database of *Arabidopsis* Transcription Factors) database website (<http://datf.cbi.pku.edu.cn>) [26]. The genomic sequences of the AP2/ERF family genes from *Vitis*, *Populus* and *Malus* were obtained from the Phytozome website and from published data [27], [28], [29], [23]. For each of these woody species, the manual annotation of DREB1/CBF and DREB2 groups was based both on the search of conserved binding domains and the analysis of the complete protein sequence.

Finally, the RNAseq database (<http://anjie.bi.up.ac.za/eucGenIE/EucGenIE.html>) was used for investigating DREB1 and DREB2 gene expression in different tissues. Raw expression data were obtained from the *Eucalyptus* genome integrative explorer (<http://eucgenie.bi.up.ac.za>) [30]. Heat map and hierarchical clustering of genes expression profiles were performed by using expander software (ACGT, <http://www.cs.tau.ac.il>).

Identification and annotation of *E. grandis* AP2/ERF proteins

Different approaches were used for the identification and annotation of all *E. grandis* AP2/ERF family members. First, the PS51032 domain of Prosite and alternatively the *Arabidopsis* AP2/ERF domains were used as query sequences against the whole translated genome of *E. grandis*. Because some predicted *E. grandis* AP2/ERF proteins were not detected in the proteome of *Arabidopsis*, *Vitis*, *Malus* or *Populus*, a manual annotation of the *E. grandis* genomic sequences was performed by combining a search of homology (<http://blast.ncbi.nlm.nih.gov/>), and gene prediction (<http://augustus.gobics.de/>). In addition, a search for new putative paralogs was performed using SCIPIO, an alignment-based tool [31]. Previously predicted and newly discovered sequences were scanned for the presence of characteristic domains (AP2 and B3) using PROSITE patterns and profiles (<http://www.expasy.org/prosite/>) or Pfam (<http://pfam.sanger.ac.uk/>). If a domain (or part of) was missing, a manual annotation was performed to complete or correct the predicted sequence. Finally, the structure and genome localization of each gene was determined by using the SCIPIO program on the resulting exhaustive set of EgrAP2/ERF family members.

Manual annotation and mapping of *EgrDREB1/CBF* genes

In addition to the automatically predicted sequences, the presence of the CBF signatures (PKK/RPAGRxKxFxETRHP and DSAWR) [32] was checked using DiAlign on the complete translated *E. grandis* genome. Following the EUCAGEN consortium recommendation, the *EgrCBF* sequences were named according to their relative position on the classified scaffolds (1 to 11). Then, the cDNA sequences of four previously described *E. gunnii* CBFs [33] were compared to the *E. grandis* genome by using the SPLIGN program proposed on the NCBI website for annotating the genomes of higher eukaryotes [34]. At this stage, the available *E. grandis* genome may still contain a number of sequencing errors leading to falsely assigned codons [35]. Indeed, some of the predicted sequences appeared to be incorrect since they exhibit wrong positions for the start and/or stop codons or unlikely intronic sequences, compared to typical CBF sequences [36], [37]. To validate the hypothesis of erroneous predictions, new sequencing experiments were performed on DNA and cDNA sequences and analyzed to propose curate sequences. Leaving out the synonym “DREB1” for simplification, the validated *EgrCBF* proteins were classified according to the *E. gunnii* orthologs by using the EMBOSS Needle program.

Phylogenetic tree construction

Multiple alignments were prepared using ClustalW [38] using default parameters (gap opening penalty = 10, gap extension penalty = 0.1) and further inspected and visually adjusted with BioEdit [39]. The resulting alignments of complete protein sequences were used in MEGA (version 5) [40] for the construction of phylogenetic trees based on Maximum Likelihood according to Jones-Taylor-Thornton model with uniform rates among sites and complete deletion of gaps/missing data. Bootstrap values were calculated from 100 replicates [41].

Plant material and stress treatments for gene expression analysis

E. grandis plants grown from commercial seeds were obtained from Australia (www.b-and-t-world-seeds.com) and *E. gunnii* x *E. dalrympleana* (clone 208) hybrid plants issued from cuttings were provided by FCBA (France). One year-old plants from the two species were cultivated under standard conditions of 25°C day/22°C night, 16 h day-length and 115 $\mu\text{moles.m}^{-2}\text{s}^{-1}$ light intensity (Lumilux Daylight 58W, Osram, München, Germany). The relative humidity was kept at approximately 80% and plants were watered as needed.

To quantify *CBF* and *DREB2* transcription in response to stressful conditions, the first experiment was conducted on *E. gunnii* x *E. dalrympleana* plants directly transferred from 22°C to 4°C for a 2h-light period followed by a 6h-dark phase, according to previous experiments in our hands [42]. The control plants were kept at 25°C/light for 2h and then at 25°C/dark for 6h. Each sample was composed of all the leaves harvested from two individual plants and pooled for RNA extraction. Transcript quantification was performed on three independent samples (biological replicates).

According to our previous data on *Eucalyptus* simplified material [43], the second experiment was performed on detached leaves which were submitted to different stress conditions. Thirty leaves (from 10 individual *E. grandis* plants) were harvested to form three independent samples of ten leaves (biological replicates). The samples were kept for 2h under light followed by a 6h-dark phase, before RNA extraction (on the pool of 10 leaves). For control, heat and cold stress, the petioles of the detached leaves were kept immersed in a liquid medium ($\frac{1}{4}$ MS) in a culture chamber. The stressed samples were submitted either to a cold-shock at 4°C or to a heat-shock at 45°C, while the control samples were kept at 25°C. For drought stress, the detached leaves were left on Whatman paper inside an incubator at 25°C using the same enlightening protocol.

Quantification of gene expression through Real-Time PCR (RT-qPCR)

RNA extraction was performed using a modified protocol of the SV Total RNA Isolation System (Promega, France). The modification consisted in complementing the NTES buffer (0.1 M NaCl; 0.01 M Tris/HCl; pH 7.5; 1 mM EDTA) with 2% polyvinylpyrrolidone (PVP) and 2% 2-mercaptoethanol [44]. Also an additional washing step was included to improve the RNA purity. Using SuperScript II and random primers (Invitrogen, France), cDNA was produced from 3 µg of extracted RNA according to the manufacturer's instructions. Based on the corrected *EgrCBF* annotation, oligonucleotide primers were designed to specifically amplify the different members of the family (S1 Table).

Due to the very high similarity between the *EgrCBF* genes, the design of specific primers for an efficient RT-qPCR amplification of each paralog was challenging, and additional control steps were needed to confirm that the PCR amplification is specific. To check sequence homology, each primer sequence was blasted against both *E. grandis* and *E. gunnii* genomes. The use of DNA calculator (<http://www.sigma-genosys.com/calc/DNAcalc.asp>) provided a technical validation for each primer. The final step for controlling the specificity of amplification was the analysis of the PCR products by gel-electrophoresis and dissociation curves.

The RT-qPCR reactions were performed in 10 µL of SYBR Green Master mix (Applied Biosystems), with 100 ng of cDNA and 300 nM of each primer. Three replicates of each cDNA were run in an ABI PRISM 7900HT 295 Sequence Detection System (Applied Biosciences, France) using a program including a first step (50°C for 2 min and 95°C for 10 min) followed by 40 cycles (95°C/15 s and 61°C/1 min). Serine/threonine-protein phosphatase 2A PP2A1 (Eucgr.B03386) and PP2A3 (Eucgr.B03031), IDH (Eucgr.F02901), SAND (Eucgr.B02502) and EF1A (Eucgr.B02473) were used together as reference genes for the normalization of RNA steady-state level, and the relative changes in gene expression were quantified using the 2- $\Delta\Delta$ Ct method [45].

The relative transcript abundances are presented as the mean expression Log₁₀ values for the experiments based on whole plants. For the experiments on detached leaves, the relative expression values are directly presented as Log₁₀ of induction rate for each stress condition in comparison to the control. In both cases, the experiments were performed on three independent biological replicates (each sample composed of material from individual plants). The mean values were analyzed for significance using the statistical T-test (p value = 0.05).

Results

Annotation and structure of the AP2/ERF transcription factor family from *E. grandis* in comparison with other plant species

From the 36376 loci encoding putative proteins in the *E. grandis* genome [3, 46], 209 were identified as AP2/ERF-like proteins based on the presence of an AP2 DNA-binding domain. When several sequences were predicted at the same genomic locus, the selection of a unique sequence was based on the highest similarity with previously described orthologs. Some predicted genes were discarded because they lack a complete AP2 domain or have a very different ORF compared to the AP2/ERF sequences from other plant species. The phylogenetic trees corresponding to each subfamily in *A. thaliana* and *E. grandis* are shown in S1, S2, S3 and S4 Figs. The analysis of key residues together with the phylogenetic trees allowed classifying the AP2/ERF members from *E. grandis* into a soloist and the four typical subfamilies, showing a conserved family structure for the plant species under study.

After the release of the *Malus* genome sequence, it was reported [3, 23] that the AP2/ERF family contains 259 members grouped according to the Nakano classification [47]. However,

Table 1. Comparison of AP2/ERF family composition (number of genes in subfamilies and groups) between *Arabidopsis thaliana*, *Vitis vinifera*, *Populus trichocarpa*, *Eucalyptus grandis* and *Malus domestica*.

AP2/ERF family	Groups	<i>A. thaliana</i>	<i>V. vinifera</i>	<i>P. trichocarpa</i>	<i>E. grandis</i>	<i>M. domestica</i>
DREB subfamily	A1	6	7	6	17	5 + 1p
	A2	8	5	8	6	14
	A3	1	0	2	1	4
	A4	16	15	26	16	18
	A5	16	8	14	17	13
	A6	10	5	11	7	9
	Subtotal		57	40	67	61 + 3p
ERF subfamily	B1	15	11	19	12	19
	B2	5	3	6	3	7
	B3	18	41	35	65	45
	B4	7	3	7	10	13
	B5	8	4	8	5	12
	B6	12	21	26	13	30
	Subtotal		65	83	101	103 + 5p
AP2 subfamily		18	20	26	21	29 + 11 like
RAV subfamily		6	6	5	6 + 2p	6
Soloist		1	1	1	1	6
Total		147	150	200	202	242

Pseudogenes are indicated as “p”.

doi:10.1371/journal.pone.0121041.t001

based on our manual annotation, four additional *CBF* sequences were identified and 21 sequences were discarded, (mainly within AP2 subfamily) because they were found as doublets (12 sequences overlapping with other AP2/ERF at the same locus) or exhibit an incomplete AP2 domain (9 sequences). The *Malus* AP2 subfamily size (51 members) predicted by Girardi and co-workers [23] is significantly smaller following our annotation, since 11 sequences have been discarded and 12 other sequences are proposed as AP2-like genes (because they exhibit high homology with AP2 genes but contain only one AP2 domain). Finally, the 242 AP2/ERF members from *Malus* were grouped in our hands according to Sakuma classification [10], which allow the structure of the AP2/ERF family to be compared to the four other species under study (Table 1).

The AP2/ERF family of *E. grandis* is medium-sized like in *Populus*, smaller than in *Malus* but higher than in *Vitis* and *Arabidopsis*. These plant species exhibit a similar size for the AP2 and RAV subfamilies and share a highly conserved soloist sequence, which is strongly divergent from the other AP2/ERF proteins and was only duplicated in *Malus* [23]. ERF, the most represented subfamily in the five species, exhibits an expansion in the tree genomes. With 108 genes, the *E. grandis* ERF subfamily represents 53.5% of the whole AP2/ERF family, which is in the same range that the other woody species (50.5% for *Populus*, 52% for *Malus* and 55.7% for *Vitis*). Within the ERF subfamily, the distribution of proteins among the B1-B6 groups is similar in *Eucalyptus* and *Vitis* but differs from the distribution in the three other species (Fig 1). Of particular note is the B3 group which with 65 members (60% of ERF subfamily) is strongly over-represented in *Eucalyptus* (Table 1 and Fig 1). In contrast to the ERF expansion, tree DREB subfamilies exhibit a similar size compared to *Arabidopsis* genome.

According to the literature, the *Malus* DREB subfamily contains various numbers of DREB1/CBF genes (2–3) and DREB2 genes (13–16) [29], [23]. In our hands, the analysis of

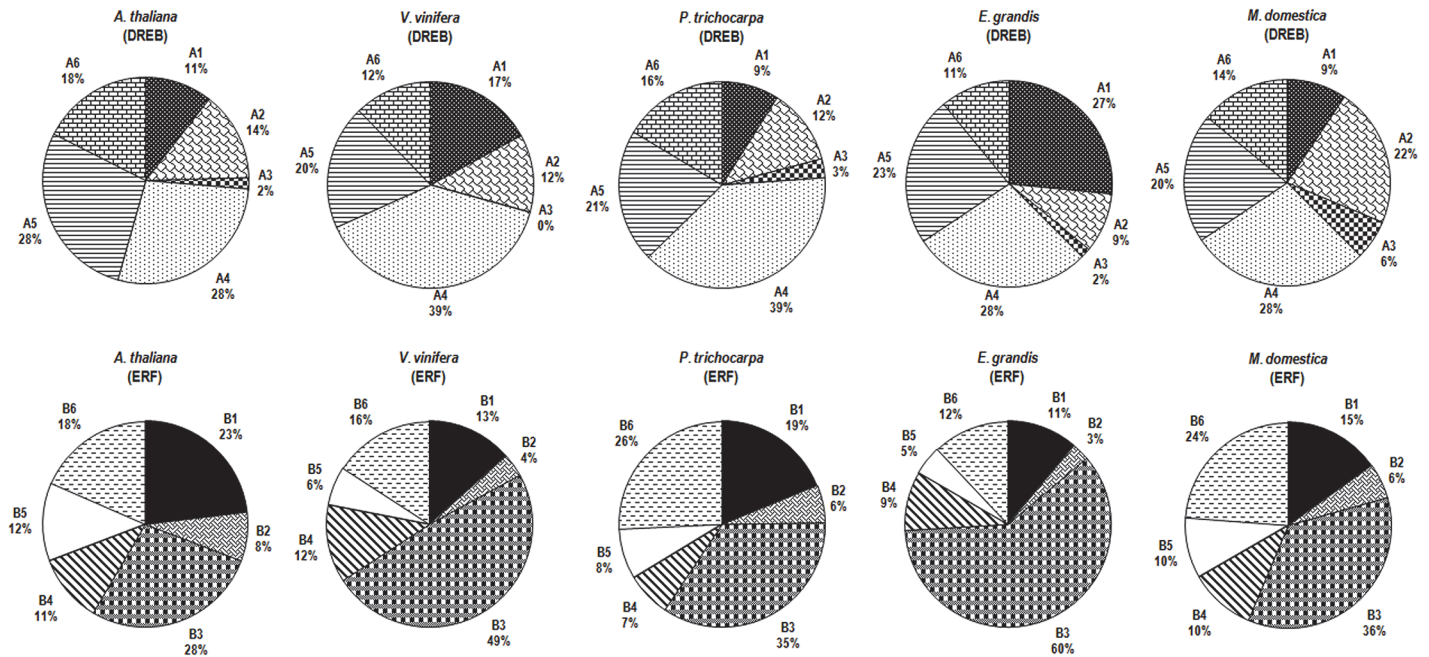

Fig 1. Distribution of genes within DREB and ERF subfamilies from *Arabidopsis thaliana*, *Vitis vinifera*, *Populus trichocarpa*, *Eucalyptus grandis* and *Malus domestica*. Pie charts depicting as sectors the relative size of each group A1-A6 and B1-B6 for respectively the DREB and ERF subfamilies. Each group is presented as a percentage of the number of corresponding DREB or ERF members, as indicated in bold in [Table 1](#).

doi:10.1371/journal.pone.0121041.g001

conserved domains and complete protein sequences led to identify six CBF and 14 DREB2 factors. For *Populus*, 17 or 18 *DREB2* (A2) genes have been reported [48, 49]. However, the alignment of the DREB2 protein sequences from the species under study showed that 10 of these 18 *Populus* DREB2 sequences cluster together and are very different from the other A2 factors (shorter sequence and different key residues), especially they do not exhibit the CMIV domain (motif 7) characteristic of the A2 group [50]. Moreover, when we blasted these 10 sequences against the NCBI databases, they were found to be closely related to B6 genes from *Arabidopsis* and *Vitis*. Therefore, we considered for further analyses only the eight remaining *PtDREB2* (A2) genes for *Populus*. For *Vitis*, one *VvDREB2* gene was identified in addition to the four members previously reported in the literature [27].

The resulting annotation data allow comparing the DREB subfamily (size and representation in %) for the five species under study (Table 1 and Fig 1). The subfamily size in *Eucalyptus* (64 genes, 31.7%) is similar to *Populus* (33.5%), but larger than in *Malus* (26%) and *Vitis* (26.6%). Within the subfamily, A4 is always the largest group (15 to 26 genes) but the distribution of the groups depends on the plant species (Fig 1). Interestingly, the A1 group (*DREB1*/*CBF*) is much more prominent in *Eucalyptus* (17 genes corresponding to 27% of the DREB subfamily) compared to the other species for which the six or seven genes correspond to 9% (*Populus* and *Malus*), 11% (*Arabidopsis*) and 18% (*Vitis*). In contrast, the *Eucalyptus* A2 group (six genes), similar to *Vitis* group (five genes, 12.5%), is smaller than in *Populus* and *Arabidopsis* (eight genes, respectively 12 and 14%) and above all in *Malus* (14 genes, 22% of DREB subfamily). Taken together this means that the tree species are similar with respect to the total number of DREB genes, but differ in their distribution within the groups especially in the number of genes in the A1 group, which is three times higher in *Eucalyptus* than in *Populus* and *Malus*. These data strongly suggest that the high number of *DREB1*/*CBFs* identified in the *E. grandis* genome is not a common feature in the tree species under study.

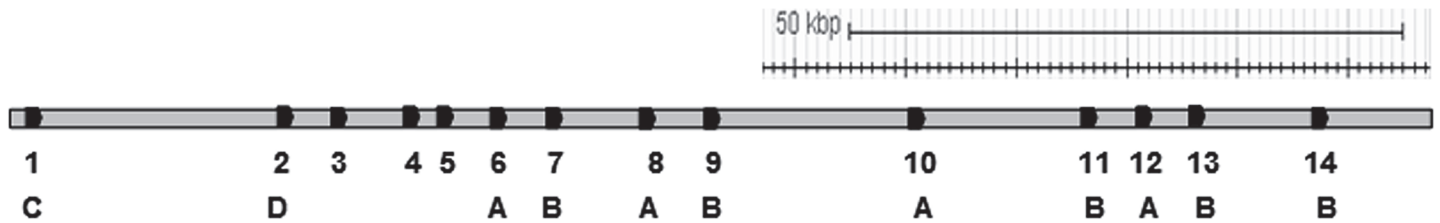

Fig 2. Schematic representation of the *EgrCBF* gene cluster on scaffold 1. The numbers correspond to *EgrCBF*1-14. The letters refer to *EguCBF*1A-, B-, C- or D-like, based on the percentage of identity between CBFs from *E. grandis* and *E. gunnii* (except for *EgrCBF*3, 4 and 5 unlabelled genes) (Table 3).

doi:10.1371/journal.pone.0121041.g002

Annotation, classification and mapping of *EgrCBF* genes

The 16 *CBF* sequences predicted by the Phytozome automatic annotation for *E. grandis* were then further investigated on the basis of their specific features, such as the presence of “signature sequences” flanking the AP2 domain and the absence of intronic sequence. An additional *EgrCBF* sequence was identified, when the four *EguCBF* sequences, previously isolated from *E. gunnii*, were mapped against the *E. grandis* genome. According to their relative position on the classified scaffolds (1 to 11), the 17 orthologs of the *E. grandis* genome were annotated as *EgrCBF*1 to *EgrCBF*17. Very interestingly, 14 *EgrCBF* genes (1–14) are located on the scaffold 1, forming a cluster in a region of about 117 Kb (from 38661043 to 38777958) which does not contain any other gene (Fig 2). Only *EgrCBF*15, 16 and 17 are located on different loci, *EgrCBF*15 on scaffold 4 and both *EgrCBF*16 and 17 on scaffold 5.

For the present work, a manual curation was required in particular for three genes (*EgrCBF*3-4-5) that were incorrectly predicted by the Phytozome automatic annotation. For both *EgrCBF*4-5 genes, predicted to have an intronic sequence, the translated sequence looked like a typical *CBF* gene. The confirmation of the absence of intron for the two genes was provided by comparing the sequences amplified from cDNA and genomic DNA. In addition, the proposed *EgrCBF*4 sequence includes a start-ATG codon at the 768 position (based on position 1 of the currently annotated sequence). The originally predicted *EgrCBF*3 also lacked a start-ATG codon at the normal position for a typical *CBF* sequence. Then the comparison of newly sequenced *EgrCBF*3 gene and *EguCBF* orthologs confirmed the presence of the four nucleotides at the positions 7–10 which are missing in the Phytozome prediction. The *EgrCBF*3 sequence could also be isolated from cDNA, showing that *EgrCBF*3 can be transcribed but, because lacking start-ATG codon, it should not be translated.

The *EgrCBF* group can be divided into subgroups according to identity (Table 2). The most similar sequences, which share at least 90% of identical residues, correspond to three different subgroups: *EgrCBF*6-8-10-12, *EgrCBF*7-9-11-13-14, and *EgrCBF*16-17. Considering this very high identity level, the corresponding sequences are likely the result from duplication events which occurred more recently than those producing the other paralogs (72 to 83%). When the *EgrCBF* sequences were compared to the *EguCBF*1A-B-C-D previously isolated from *E. gunnii*, 11 sequences were found to exhibit a spectacularly high identity (from 91 to 99%, Table 3). While *EgrCBF*1 and *EgrCBF*2 are the closest orthologs of respectively *EguCBF*1C and D, the two main subgroups (*EgrCBF*6-8-10-12 and *EgrCBF*7-9-11-13-14) correspond respectively to *EguCBF*1A and *EguCBF*1B, and therefore named CBFA- and CBF B-like.

Phylogenetic relationships within CBF and DREB2 groups from *Eucalyptus*, *Arabidopsis*, *Vitis*, *Malus* and *Populus*

The multiple alignments of CBF protein sequences from *Arabidopsis*, *Vitis*, *Populus*, *Malus* and *Eucalyptus* (*E. grandis* and *E. gunnii*) were used to generate the phylogenetic tree presented

Table 3. Pairwise sequence comparison (% of identity) between EgrCBF and EguCBF proteins respectively from *E. grandis* and *E. gunnii*.

	EgrCBF1	EgrCBF2	EgrCBF3	EgrCBF4	EgrCBF5	EgrCBF6	EgrCBF7	EgrCBF8	EgrCBF9	EgrCBF10	EgrCBF11	EgrCBF12	EgrCBF13	EgrCBF14	EgrCBF15	EgrCBF16	EgrCBF17
EguCBF _A	75	75	59	75	60	95	79	80	91	78	93	80	81	46	39	41	
EguCBF _B	76	75	57	73	58	81	95	98	80	96	81	98	99	46	40	40	
EguCBF _C	95	73	55	66	54	76	72	74	73	72	74	74	74	46	40	40	
EguCBF _D	75	97	68	81	67	75	72	73	73	72	74	73	74	47	37	40	

Bolded numbers correspond to the most identical sequences (>90% identity).

doi:10.1371/journal.pone.0121041.t003

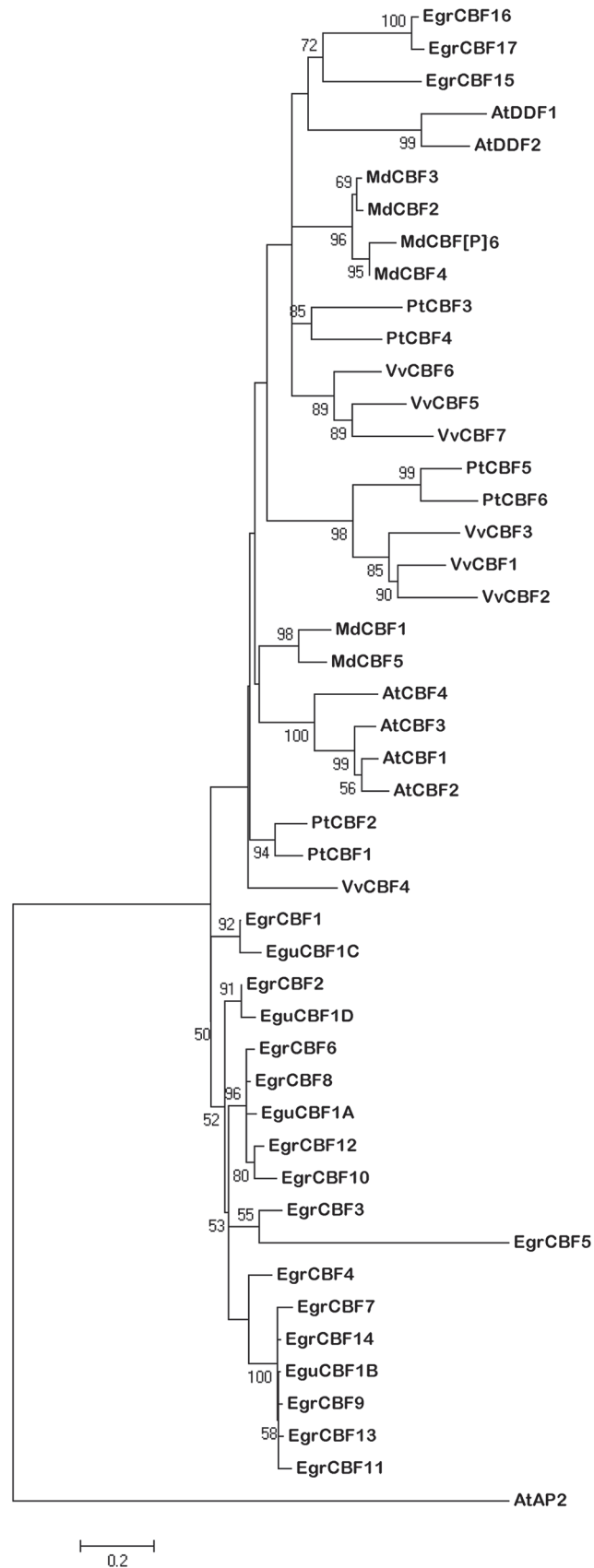

Fig 3. Phylogenetic analyses of CBF proteins (A1 group) from *Eucalyptus grandis*, *Eucalyptus gunnii*, *Vitis vinifera*, *Malus domestica*, *Populus trichocarpa* and *Arabidopsis thaliana* by the Maximum Likelihood method using Mega 5. The tree was constructed from the sequence alignment of full-length proteins of the EgrCBF1-17 from *E. grandis*, Egu CBF1A-B-C-D from *E. gunnii*, VvCBF1-7 from *V. vinifera*, PtCBF1-6 from *P. trichocarpa*, AtCBF1-4 and AtDDF1-2 from *A. thaliana* and MdCBF1-6 from *Malus domestica*. AtAP2 (At5G557390.1) is a member of the AP2 subfamily used for rooting the phylogenetic tree. Low Bootstrap values (<50) were removed from the tree.

doi:10.1371/journal.pone.0121041.g003

their preferential expression in woody tissues (Group I), shoot tips (Group II) or leaf tissues (Group III). Each group includes both *CBF* and *DREB2* genes. Surprisingly, 6 of the 19 *CBF/DREB2* genes are preferentially expressed in phloem tissue in addition to *DREB2-5* which exhibits the highest expression value (Log_{10} FKPM) in xylem tissue. In the “leaf group”, the highest expression levels mainly concern mature leaves.

The *CBF* or *DREB2* transcript abundance was quantified on leaves from *E. gunnii* x *E. dalrympleana* cold-treated plants in comparison with standard conditions (Fig 6). This expression analysis shows that most of the *CBF* and *DREB2* genes are expressed in standard conditions. The statistical analysis indicates a significant cold induction for most of the *CBF* genes (*CBF1-14*) but only two *DREB2* genes (*DREB2-3* and *-5*). From the 23 genes under study, *CBF14* exhibits the strongest expression under cold and *CBF9* shows the highest basal expression. Interestingly, these two genes are close orthologs of respectively *EguCBF1B* and *EguCBF1A*, which were chosen for over-expression in *E. urophylla* x *E. grandis* transgenic lines [24].

In addition, the responses of these genes to different stressful conditions (cold, heat or drought) were evaluated on detached leaves from *E. grandis*, since the use of this simplified system was validated previously [43]. In this paper, the induction of different *CBF* genes of cold-stressed pieces of leaves was shown to be representative of *CBF* expression profiles from *Eucalyptus* cold-treated plants.

In the present paper, the gene induction rates (stress condition compared to control) are expressed (Fig 7) as the Log_{10} of the mean values (a 2-fold rate increase in gene expression corresponds to Log_{10} values > 0.33). In this experiment, all the *CBF* genes were found to be cold-induced versus 4/6 *DREB2* genes. In agreement with the presented data on whole plants, the overall *CBF* group exhibits a more intense cold response than the *DREB2* group. At the opposite, under drought, a higher proportion of *DREB2* genes (4/6) are up-regulated compared to the *CBF* genes (4/17), even though the applied stimulus is overall triggering a much weaker response compared to cold treatment. Finally, all the *CBF* and *DREB2* genes were found to be heat-inducible.

Overall, these analyses confirm that both *CBF* and *DREB2* groups participate in cold, drought and above all heat response in *E. grandis* and *E. gunnii* x *E. dalrympleana*. However, *CBF* group would be mostly involved in cold response and *DREB2* mainly in drought response. Moreover, the data evidence that, for these two species of *Eucalyptus*, regulation is not redundant within the *CBF/DREB2* groups since each gene exhibits a distinct pattern of response in different tissues and stressful conditions.

Discussion

A comprehensive search for the *Eucalyptus* AP2/ERF transcription factors led to the identification of 202 genes which is similar to *Populus* and ranges in between *Vitis* (147 genes) and *Zea mays* (292 members) [51]. A previous comparison of the AP2/ERF gene family size between eudicots, monocots and chlorophyta, have already shown that this size radiates along with land conquest [52]. Actually, most of the observed expansions in AP2/ERF families in plants seem to be associated to recent genome duplications (*Eucalyptus*, *Populus* and *Malus*) or triplications

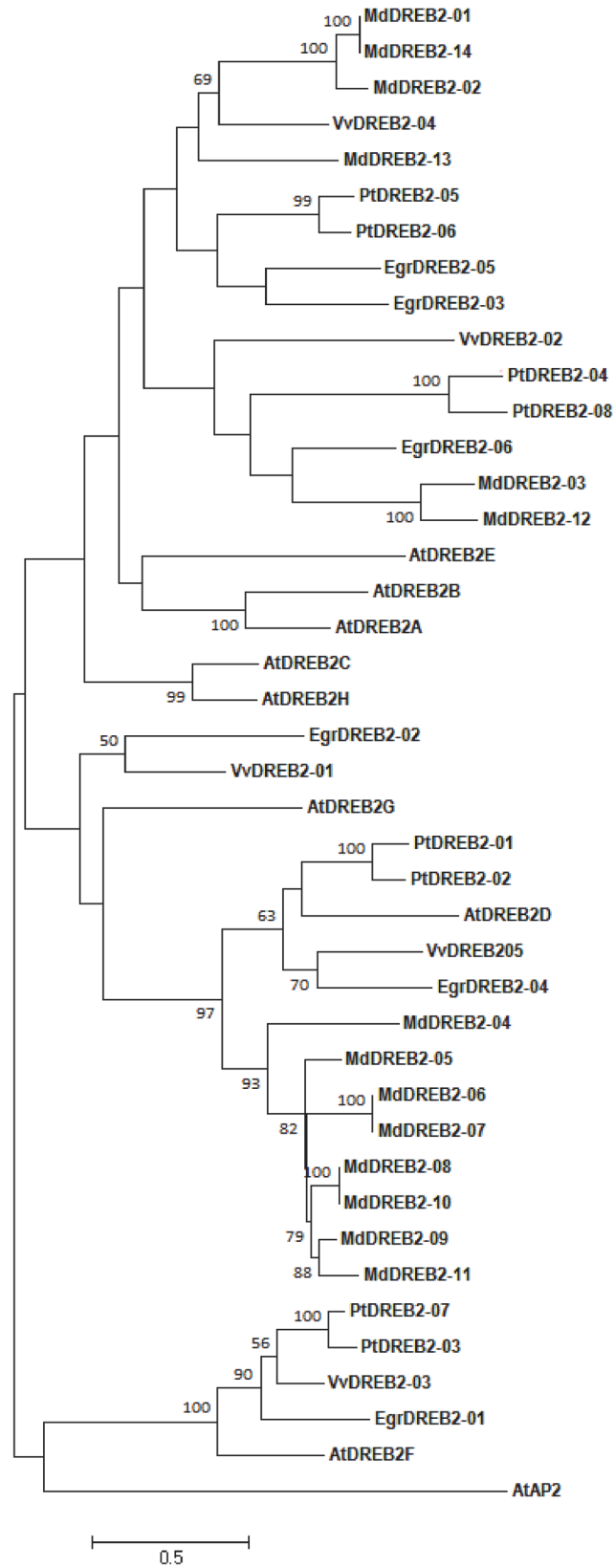

Fig 4. Phylogenetic analyses of DREB2 proteins (A2 group) from *Eucalyptus grandis*, *Vitis vinifera*, *Malus domestica*, *Populus trichocarpa* and *Arabidopsis thaliana* by the Maximum Likelihood method using Mega 5. The tree was constructed from the sequence alignment of full-length protein of AtDREB2-(A-H) from *A. thaliana*, EgrDREB2-(1–6) from *E. grandis*, VvDREB2-(1–5) from *V. vinifera*, PtDREB2-(1–8) from *P. trichocarpa*, MdDREB2-(1–14) from *Malus domestica*. AtAP2 (At5G557390) is a member of AP2 subfamily used for rooting the phylogenetic tree. Low Bootstrap values (<50) were removed from the tree.

doi:10.1371/journal.pone.0121041.g004

(*Brassica rapa*) [53], [54], [55], [23]. The structure and phylogeny of the AP2/ERF family are similar for the species under study. The presence of the same subfamilies composed of the same groups suggests that the appearance of the AP2/ERF structure predates the divergence of dicotyledonous species [28, 47]. Compared to Arabidopsis, the tree species under study are characterized by a much larger ERF subfamily beside a similar size for DREB subfamily. Current knowledge states that DREB factors activate genes involved in cold and water deficit response, while ERF factors directly regulate pathogenesis-related (PR) gene expression but some ERF and DREB genes were shown to be activated by both biotic and abiotic stimuli [56].

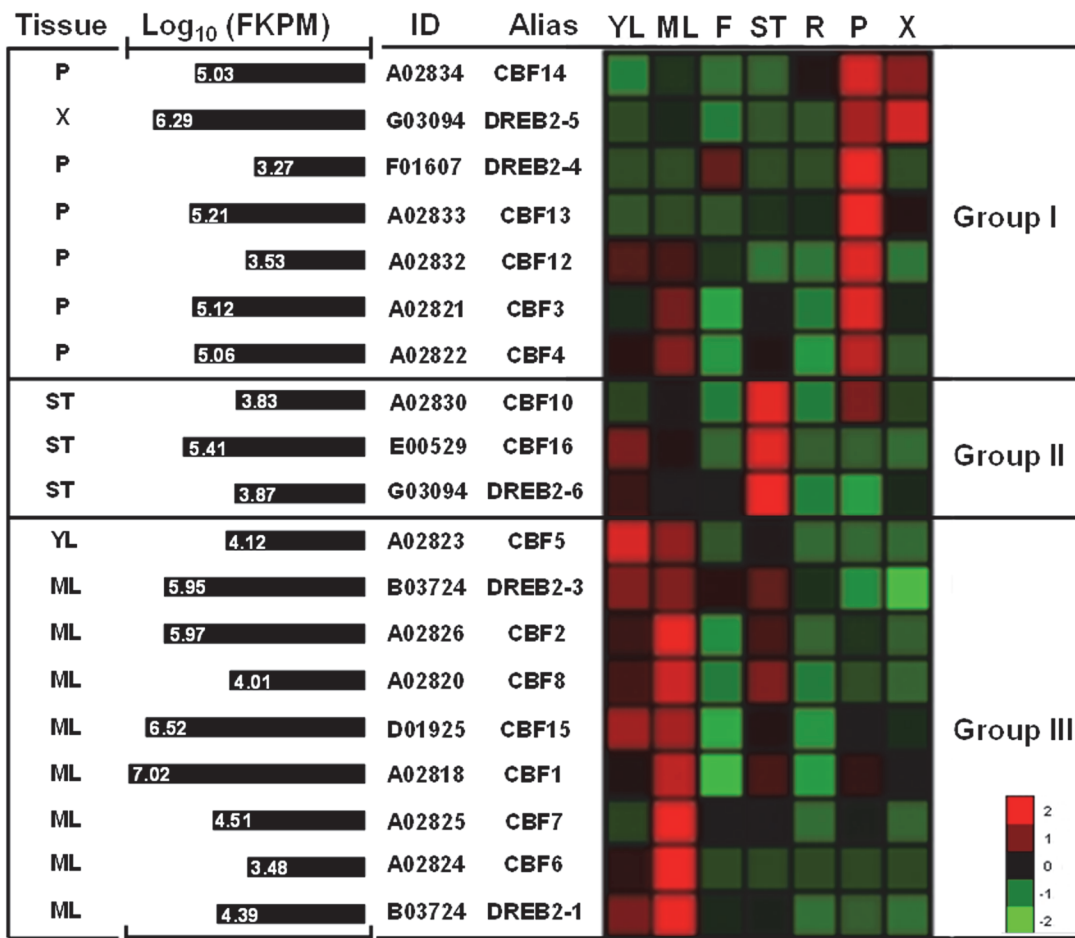

Fig 5. CBF and DREB2 gene expression profiles from RNAseq data corresponding to various tissues from *E. grandis*. Raw expression data were obtained from the *Eucalyptus* genome integrative explorer (<http://eucgenie.bi.up.ac.za>). Expression analysis is presented for 14 *EgrCBF* and five *EgrDREB2* genes which were automatically annotated, but do not concerns the four additional CBF genes which were manually annotated in our hands. Gene name and accession numbers are mentioned respectively in Alias and ID columns. Heat map and hierarchical clustering of gene expression profiles (right panel) were performed by using expander software (ACGT, <http://www.cs.tau.ac.il>). For each gene, the highest absolute expression value (Log₁₀ FKPM) is represented in the left panel with the indication of corresponding tissue. YL, young leaves; ML, mature leaves; F, flowers; ST, shoot tips; R, roots P, phloem; X, xylem.

doi:10.1371/journal.pone.0121041.g005

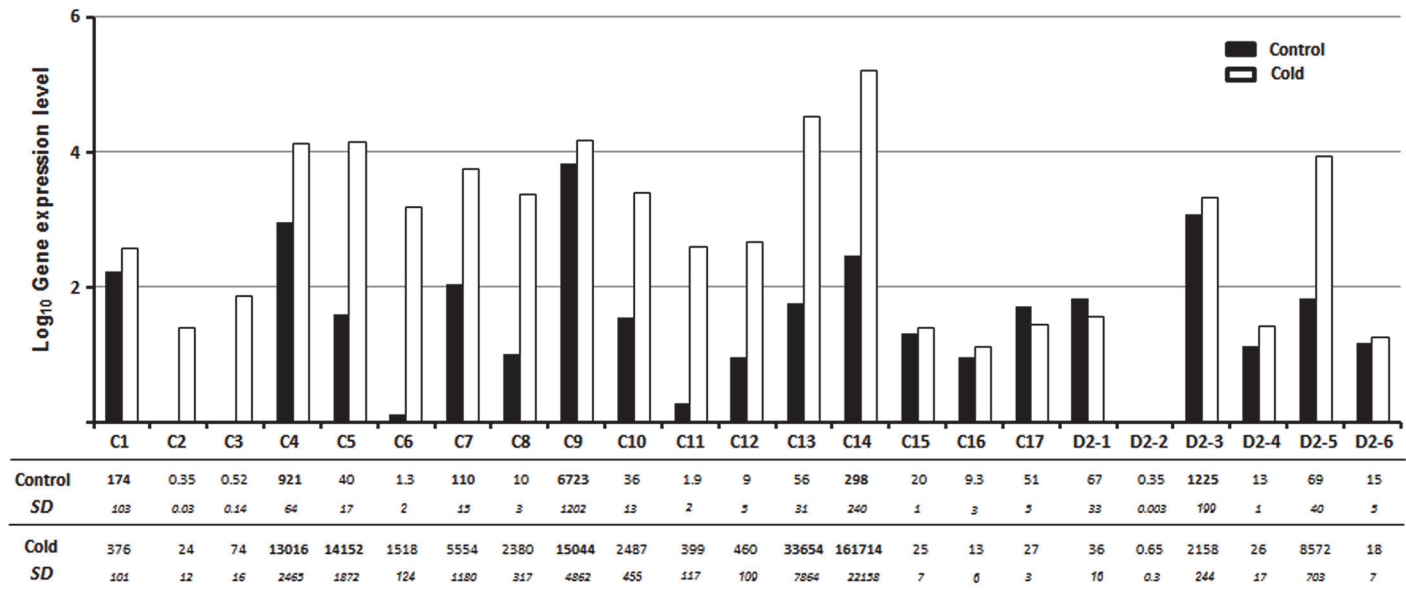

Fig 6. *EgrCBF* and *EgrDREB2* transcript abundance in leaves of *E. gunnii* x *E. dalrympleana* plants grown for 8h under 4°C cold (white) or control conditions (black). Gene expression levels of *EgrCBF* (C1 to C17) and *EgrDREB2* (D2-1 to -6) were quantified on leaves from cold-treated *Eucalyptus* plants. The experimental values from RT-qPCR (conducted on three biological replicates) were normalized using five reference genes and the mean values (n = 3) were analyzed for significance using the statistical T-test (p value < 0.05). The resulting histograms represent Log₁₀ of relative transcript abundance of the *CBF* and *DREB2* in control or cold conditions. * means a significant 2-fold rate increase in gene expression (cold/control)

doi:10.1371/journal.pone.0121041.g006

Actually, most of these ERF in *Eucalyptus* are B3 factors. More than other ones, these proteins are often associated to the response to both biotic and abiotic stresses, especially through the binding to CE1 element [57],[58], [59].

With regard to the *Eucalyptus* *DREB2* subfamily, the obvious feature lies in the presence of numerous *EgrCBF* genes together with a moderate number of *EgrDREB2* genes. The phylogenetic analysis suggests that the *DREB2* forms existed prior to the plant species divergence, whereas the *CBF* may have evolved more recently and independently in each plant species. Up to now, the number of *CBF* genes in dicotyledonous plants is often around six, except for *Chrysanthemum* [60] and *Medicago truncatula* [61]. In the first case, the 13 *CBF* isolated genes are likely related to the hexaploid *Chrysanthemum* genome; 17 *CBF* genes have been detected in *M. truncatula* genome which has experienced high rates of local gene duplications.

The occurrence of clustered *CBF* genes is a quite common feature for several plant species such as *Arabidopsis*, wheat and rice [9, 25, 62], but the number of *CBF* duplication events is much higher in *Medicago* and *Eucalyptus*. Duplicated genes can be conserved and associated with sub-functionalization and/or neo-functionalization [63] or become pseudogenes. The intriguing high number of *EgrCBF* genes may give rise to doubts as to their transcription. Given that all the *EgrCBFs* are expressed and that only one is predicted not to be translated, it then raises questions about the role of these very similar multiple copies in *Eucalyptus*. Are they required to ensure an essential function or is there redundancy in their function? Knox and co-workers showed that the presence of two extra-*CBF* gene copies in a barley genotype contributes to its higher freezing tolerance [25], suggesting that amplification of genomic regions encompassing *CBFs* would be a mean to increase *CBF* transcription rate and provide a selective advantage during winter. Also the *CBF* family expansion in the *Pooideae* during the Eocene-Oligocene climate cooling was strongly suggested to play a role in the adaptation to a cool climate [64]. Considering its tropical and subtropical origin and ever-growing habit, *E.*

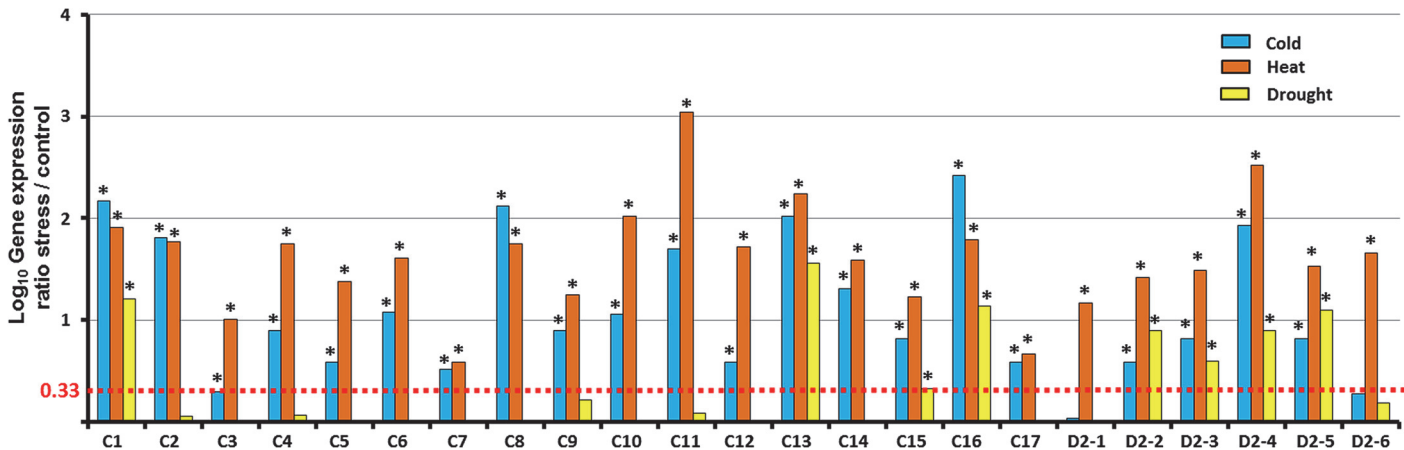

Fig 7. *EgrCBF* and *EgrDREB2* gene induction rates for *E. grandis* detached leaves incubated for 8 hours under cold (4°C, blue), heat (45°C, red) or drought (yellow), in comparison to control conditions. Transcript abundance of *EgrCBF* (C1 to C17) and *EgrDREB2* (D2-1 to -6) was quantified through RT-qPCR on detached leaves from 10 individual *E. grandis* plants. The experimental values were normalized using two reference genes and the mean values issued from three independent biological replicates (n = 3) were analyzed for significance using the statistical T-test (p value < 0.01). The histograms represent the relative expression values as Log₁₀ of induction rates (stress/control). * means a significant 2-fold rate increase in gene expression (stress/control)

doi:10.1371/journal.pone.0121041.g007

grandis is reported to exhibit a surprisingly high level of frost tolerance as a result of a very rapid hardening capacity [65]. *Eucalyptus* genus is also known as heat-tolerant [66]. The *CBF* could, at least in part, participate in the control of the *Eucalyptus* cold acclimation since over-expression of an *E. gunnii* *CBF* ortholog in *Eucalyptus* was found to increase cold tolerance [24]. Interestingly, the protein corresponding to this transgene is very similar (98–99%) to *EgrCBF*13 and 14 which were observed as the most expressed in the present paper, such validating their functionality. Therefore, duplication and retention of the *CBF* genes, most cold- and heat-responsive may contribute to a massive activation of target genes (such as dehydrin) as previously observed during *Eucalyptus* cold acclimation [67].

On the other hand, the different copies may be not equivalent for regulation or function, at least at the subgroup level. In *Arabidopsis*, the divergence of the *CBF4* gene from the *CBF1-3* tandem proved not to be due to selection of entirely new functions, but to diversification of promoter regulatory elements responding to different environmental signals [68, 69]. In *E. gunnii*, previous studies have shown a complementary regulation of the four *CBF* genes under various cold conditions [33]. The present study clearly shows that the expression of the 17 *EgrCBF* genes is differential according to the plant tissue and the applied stress. Not only these genes are not specific to one stress but also they are not equivalent for regulation. Therefore the high number of *CBF* copies may provide both efficiency and plasticity to the *Eucalyptus* response to environmental stresses.

The unusual *CBF* over-representation, in contrast to the moderate number of *DREB2* genes in *Eucalyptus* also raises the question about the adaptation of this species to cold, heat or drought. It was originally thought that *CBF* genes are the main regulators of cold response when *DREB2* group is rather involved in osmotic response, but accumulation of genomic data on different species have shown some conflicts with respect to this classical model [7]. The present study on *Eucalyptus* species shows that both groups are regulated by both stimuli, but *CBF* are more cold-sensitive than *DREB2* genes which look more involved in drought response. The regulation of *CBF* genes by various dehydrative stresses was previously shown in *E. gunnii* [33], *Vitis* [70], *Malus* [21], *Prunus* [22] and *Populus* [50]. In *Arabidopsis*, the *CBF* group includes the strictly cold-induced genes (*CBF1-3*) together with the drought- and salt-responsive

genes (*CBF4*, *DDF1* and *DDF2*) [71]. Conversely, cold-responsive *DREB2* genes have been reported for some grass species [56, 72] *Arabidopsis* [58], *Malus* [6] or *Populus* [50]. Therefore, the numerous *CBF* and *DREB2* genes may together be involved in the control of temperature stress in *Eucalyptus*. One obvious characteristic of *CBF/DREB2* genes with regard to transcriptional regulation in *Eucalyptus* lies in the strong response to heat which concerns all the 23 members. This feature does not look so common since for example the recent publication [73] on heat transcriptome in poplar states only 19 up-regulated *DREB* genes versus 23 down-regulated for the six groups (A1-A6 containing 60 genes).

From our results, one may therefore hypothesize that, in *Eucalyptus*, the large *CBF* group would complete the limited number of *DREB2* genes, for regulating multiple abiotic stress responses. This does not seem so surprising because expansion of *Eucalyptus* into Australia occurred during the late Miocene when the climate became colder and drier [74]. This means that this tree was submitted to a double selection pressure. As regards the cold response, the higher number of *CBF* genes in *Eucalyptus* compared to other trees highlights the very distinct functional strategies to face winter mainly based on frost tolerance for *Eucalyptus* versus frost avoidance for *Populus* or *Malus*. In addition, all the *CBF* and *DREB2* genes exhibit a significant induction by heat stress. It is now commonly accepted that *Eucalyptus* became the dominant sclerophyll forest in Australia, about 140 000 years ago, when Aboriginal people arrived because of “fire dick” agriculture [75]. It is proposed that *Eucalyptus* plants were merely pre-adapted for fire survival and expansion [66]. The presence of a large number of heat-responsive *CBFs* might be a piece of this pre-adaptation by controlling proteins involved in heat protection, like HSP. In conclusion, *CBF* and *DREB2* may be key players of cross-talks between cold, heat and drought responses which appear to be strong in *Eucalyptus* both for the regulatory pathways and the resulting adaptive mechanisms. The unusual expansion of the *EgrCBF* group, together with a differential gene regulation could be a way of counterbalancing the permanent exposure to a changing environment and may contribute to a wider response to a range of environmental changes including at least heat shock.

In conclusion, this investigation of the AP2/ERF family in *Eucalyptus* with regard to other woody species reveals some common features, such as family size and global structure. As more and more reported for plants, the stress-related groups *CBF* and *DREB2* prove differentially but not specifically regulated by various abiotic stresses, *CBF* members participating mainly in the cold response and *DREB2* genes in the drought response. More surprising with regard to other species is the strong response to heat stress for all the *CBF* and *DREB2* members.

Above all, *Eucalyptus* genome is marked out by a dramatic over-representation of *CBF* genes, which does not appear like a woody plant feature. This result gives evidence of intense and recent duplication events and suggests their importance in the adaptation of this ever-growing tree to cold, drought and above all heat. Overall, this result strongly supports the hypothesis of Myburg and coworkers [3] that the intense genome-wide duplications in *Eucalyptus* (the highest reported to date) may be important for adaptive evolution of this tree in dynamically changing environments.

Finally, these data make now possible to envisage a functional characterization including spatiotemporal expression studies for identifying the most relevant candidate genes (*CBF* and *DREB2*) towards improving stress tolerance (cold, drought or combined abiotic stresses).

Supporting Information

S1 Fig. Phylogenetic tree of the DREB subfamily from *A. thaliana* and *E. grandis*. The tree was generated using Mega 5 program by the Maximum Likelihood method. Bootstrap values

are indicated at each branch. For the *E. grandis* DREB subfamily, the relationship between Phytozome gene IDs and the names used in this paper is indicated in [S2 Table](#).
(TIF)

S2 Fig. Phylogenetic tree of the ERF subfamily from *A. thaliana* and *E. grandis*. The tree was generated using Mega 5 program by the Maximum Likelihood method. Bootstrap values are indicated at each branch. For the *E. grandis* ERF subfamily, the relationship between Phytozome gene IDs and the names used in this paper is indicated in [S2 Table](#).
(TIF)

S3 Fig. Phylogenetic tree of the RAV subfamily from *A. thaliana* and *E. grandis*. The tree was generated using Mega 5 program by the Maximum Likelihood method. Bootstrap values are indicated at each branch. For the *E. grandis* RAV subfamily, the relationship between Phytozome gene IDs and the names used in this paper is indicated in [S2 Table](#).
(TIF)

S4 Fig. Phylogenetic tree of the AP2 subfamily from *A. thaliana* and *E. grandis*. The tree was generated using Mega 5 program by Maximum Likelihood method. Bootstrap values are indicated at each branch. For the *E. grandis* AP2 subfamily, subfamily, the relationship between Phytozome gene IDs and the names used in this paper is indicated in [S2 Table](#).
(TIF)

S1 Table. List of oligonucleotide sequences used in RT-qPCR reactions; the Tm and the amplicon size (bp) are provided.
(DOC)

S2 Table. Correspondence between AP2/ERF gene IDs from phytozome and names used in this paper. “Eucagen name” associates the subfamily name with the relative position on the scaffolds (1 to 11). “Generic name” given to EgrCBF(1–17) and EgrDREB2-(1–6) from literature uses and genome location.
(DOC)

Acknowledgments

We acknowledge A. Myburg for providing us with RNAseq data on different tissues from *E. grandis*. We are also very grateful to Dr A. Nassuth from Guelph University (Canada) for critical reviewing the manuscript and English editing.

Author Contributions

Conceived and designed the experiments: FM CD CM CT. Performed the experiments: PBC SA HSC FM GM. Analyzed the data: PBC SA HSC FM CD GM CM CT. Contributed reagents/materials/analysis tools: PBC SA GM FM. Wrote the paper: CM FM CT.

References

1. FAO. State of the World's Forests 2007. Rome: Electronic Publishing Policy and Support Branch, Communication Division, FAO; 2007.
2. Hinchee M, Zhang C, Chang S, Cunningham M, Hammond W, Nehra N. Biotech Eucalyptus can sustainably address society's need for wood: the example of freeze tolerant Eucalyptus in the southeastern U.S. BMC Proceedings. 2011; 5(Suppl 7):I24. PubMed doi: [10.1186/1753-6561-5-S7-I24](https://doi.org/10.1186/1753-6561-5-S7-I24)
3. Myburg AA, Grattapaglia D, Tuskan GA, Hellsten U, Hayes RD, Grimwood J, et al. The genome of *Eucalyptus grandis*. Nature. 2014; 510(7505):356–62. Epub 2014/06/12. doi: [10.1038/nature13308](https://doi.org/10.1038/nature13308) PubMed PMID: [24919147](https://pubmed.ncbi.nlm.nih.gov/24919147/).

4. Okamura JK, Caster B, Villarroel R, Van Montagu M, Jofuku KD. The AP2 domain of APETALA2 defines a large new family of DNA binding proteins in Arabidopsis. *Proc Natl Acad Sci USA*. 1997; 94(13):7076–81. PMID: [9192694](#)
5. Feng JX, Liu D, Pan Y, Gong W, Ma LG, Luo JC, et al. An annotation update via cDNA sequence analysis and comprehensive profiling of developmental, hormonal or environmental responsiveness of the Arabidopsis AP2/EREBP transcription factor gene family. *Plant Mol Biol*. 2005; 59(6):853–68. doi: [10.1007/s11103-005-1511-0](#) PubMed PMID: [16307362](#).
6. Matsukura S, Mizoi J, Yoshida T, Todaka D, Ito Y, Maruyama K, et al. Comprehensive analysis of rice DREB2-type genes that encode transcription factors involved in the expression of abiotic stress-responsive genes. *Mol Genet Genomics*. 2010; 283(2):185–96. doi: [10.1007/s00438-009-0506-y](#) PubMed PMID: [20049613](#).
7. Lata C, Prasad M. Role of DREBs in regulation of abiotic stress responses in plants. *J Exp Bot*. 2011; 62(14):4731–48. err210 [pii] doi: [10.1093/jxb/err210](#) PubMed PMID: [21737415](#).
8. Zhou M-L, Yi-Xiong T, Yan-min W. Genome-wide analysis of APE/ERF transcription factor family in Zea maize *Current Bioinformatics*. 2013; 7(3). doi: [10.2174/157489312802460776](#)
9. Sharoni AM, Nuruzzaman M, Satoh K, Shimizu T, Kondoh H, Sasaya T, et al. Gene structures, classification and expression models of the AP2/EREBP transcription factor family in rice. *Plant Cell Physiol*. 2011; 52(2):344–60. pcp196 [pii] doi: [10.1093/pcp/pcq196](#) PubMed PMID: [21169347](#).
10. Sakuma Y, Liu Q, Dubouzet J, Abe H, Shinozaki K, Yamaguchi-Shinozaki K. DNA-binding specificity of the ERF/AP2 domain of Arabidopsis DREBs, transcription factors involved in dehydration- and cold-inducible gene expression. *Biochem Biophys Res Commun*. 2002; 290(3):998–1009. PMID: [11798174](#)
11. Elliott RC, Betzner AS, Huttner E, Oakes MP, Tucker WQ, Gerentes D, et al. AINTEGUMENTA, an APETALA2-like gene of Arabidopsis with pleiotropic roles in ovule development and floral organ growth. *Plant Cell*. 1996; 8(2):155–68. PubMed PMID: [8742707](#); PubMed Central PMCID: PMCPMC161088.
12. Chuck G, Meeley RB, Hake S. The control of maize spikelet meristem fate by the APETALA2-like gene indeterminate spikelet1. *Genes Dev*. 1998; 12(8):1145–54. PubMed PMID: [9553044](#); PubMed Central PMCID: PMCPMC316712.
13. Boutilier K, Offringa R, Sharma VK, Kieft H, Ouellet T, Zhang L, et al. Ectopic expression of BABY BOOM triggers a conversion from vegetative to embryonic growth. *Plant Cell*. 2002; 14(8):1737–49. PubMed PMID: [12172019](#); PubMed Central PMCID: PMCPMC151462.
14. Alonso JM, Stepanova AN, Solano R, Wisman E, Ferrari S, Ausubel FM, et al. Five components of the ethylene-response pathway identified in a screen for weak ethylene-insensitive mutants in Arabidopsis. *Proc Natl Acad Sci U S A*. 2003; 100(5):2992–7. 0438070100 [pii] doi: [10.1073/pnas.0438070100](#) PubMed PMID: [12606727](#); PubMed Central PMCID: PMCPMC151454.
15. Hu YX, Wang YX, Liu XF, Li JY. Arabidopsis RAV1 is down-regulated by brassinosteroid and may act as a negative regulator during plant development. *Cell Res*. 2004; 14(1):8–15. doi: [10.1038/sj.cr.7290197](#) PubMed PMID: [15040885](#).
16. Sohn KH, Lee SC, Jung HW, Hong JK, Hwang BK. Expression and functional roles of the pepper pathogen-induced transcription factor RAV1 in bacterial disease resistance, and drought and salt stress tolerance. *Plant Mol Biol*. 2006; 61(6):897–915. PubMed PMID: [16927203](#).
17. Agarwal P, Jha B. Transcription factors in plants and ABA dependent and independent abiotic stress signalling. *Biol Plant*. 54: Springer; 2010. p. 201–12.
18. Mizoi J, Shinozaki K, Yamaguchi-Shinozaki K. AP2/ERF family transcription factors in plant abiotic stress responses. *Biochim Biophys Acta*. 2011. S1874-9399(11)00142-8 [pii] doi: [10.1016/j.bbagr.2011.08.004](#) PubMed PMID: [21867785](#).
19. Fujimoto SY, Ohta M, Usui A, Shinshi H, Ohme-Takagi M. Arabidopsis ethylene-responsive element binding factors act as transcriptional activators or repressors of GCC box-mediated gene expression. *Plant Cell*. 2000; 12(3):393–404. PubMed PMID: [10715325](#); PubMed Central PMCID: PMCPMC139839.
20. Ohme-Takagi M, Shinshi H. Ethylene-inducible DNA binding proteins that interact with an ethylene-responsive element. *Plant Cell*. 1995; 7(2):173–82. 7/2/173 [pii] doi: [10.1105/tpc.7.2.173](#) PubMed PMID: [7756828](#); PubMed Central PMCID: PMCPMC160773.
21. Zhao T, Liang D, Wang P, Liu J, Ma F. Genome-wide analysis and expression profiling of the DREB transcription factor gene family in Malus under abiotic stress. *Mol Genet Genomics*. 2012; 287(5):423–36. doi: [10.1007/s00438-012-0687-7](#) PubMed PMID: [22526429](#).
22. Artlip TS, Wisniewski ME, Bassett CL, Norelli JL. CBF gene expression in peach leaf and bark tissues is gated by a circadian clock. *Tree Physiol*. 2013; 33(8):866–77. Epub 2013/08/21. doi: [10.1093/treephys/tpt056](#) PubMed PMID: [23956128](#).

23. Girardi CL, Rombaldi CV, Dal Cero J, Nobile PM, Laurens F, Bouzayen M, et al. Genome-wide analysis of the AP2/ERF superfamily in apple and transcriptional evidence of ERF involvement in scab pathogenesis. *Scientia Horticulturae*. 2013; 151(0):112–21. <http://dx.doi.org/10.1016/j.scienta.2012.12.017>.
24. Navarro M, Ayax C, Martinez Y, Laur J, El Kayal W, Marque C, et al. Two EguCBF1 genes overexpressed in *Eucalyptus* display a different impact on stress tolerance and plant development. *Plant Biotechnol J*. 2011; 9(1):50–63. Epub 2010/05/25. doi: [10.1111/j.1467-7652.2010.00530.x](https://doi.org/10.1111/j.1467-7652.2010.00530.x) PubMed PMID: [20492548](https://pubmed.ncbi.nlm.nih.gov/20492548/).
25. Knox AK, Dhillon T, Cheng H, Tondelli A, Pecchioni N, Stockinger EJ. CBF gene copy number variation at Frost Resistance-2 is associated with levels of freezing tolerance in temperate-climate cereals. *Theor Appl Genet*. 2010; 121(1):21–35. doi: [10.1007/s00122-010-1288-7](https://doi.org/10.1007/s00122-010-1288-7) PubMed PMID: [20213518](https://pubmed.ncbi.nlm.nih.gov/20213518/).
26. Guo A, He K, Liu D, Bai S, Gu X, Wei L, et al. DATF: a database of Arabidopsis transcription factors. *Bioinformatics*. 2005; 21(10):2568–9. bti334 [pii] doi: [10.1093/bioinformatics/bti334](https://doi.org/10.1093/bioinformatics/bti334) PubMed PMID: [15731212](https://pubmed.ncbi.nlm.nih.gov/15731212/).
27. Zhuang J, Peng RH, Cheng ZM, Zhang J, Cai B, Zhang Z, et al. Genome-wide analysis of the putative AP2/ERF family genes in *Vitis vinifera*. *Scientia Horticulturae*. 2009; 123(1):73–81. doi: [10.1016/j.scienta.2009.08.002](https://doi.org/10.1016/j.scienta.2009.08.002) PubMed WOS:000271159000013.
28. Licausi F, Giorgi FM, Zenoni S, Osti F, Pezzotti M, Perata P. Genomic and transcriptomic analysis of the AP2/ERF superfamily in *Vitis vinifera*. *BMC Genomics*. 2010; 11:719. 1471-2164-11-719 [pii] doi: [10.1186/1471-2164-11-719](https://doi.org/10.1186/1471-2164-11-719) PubMed PMID: [21171999](https://pubmed.ncbi.nlm.nih.gov/21171999/); PubMed Central PMCID: [PMCPMC3022922](https://pubmed.ncbi.nlm.nih.gov/PMC3022922/).
29. Zhuang J, Chen JM, Yao QH, Xiong F, Sun CC, Zhou XR, et al. Discovery and expression profile analysis of AP2/ERF family genes from *Triticum aestivum*. *Mol Biol Rep*. 2011; 38(2):745–53. doi: [10.1007/s11033-010-0162-7](https://doi.org/10.1007/s11033-010-0162-7) PubMed PMID: [20407836](https://pubmed.ncbi.nlm.nih.gov/20407836/).
30. Hefer C, Mizrahi E, Joubert F, Myburg A, editors. The *Eucalyptus* genome integrative explorer (EucGenIE): a resource for *Eucalyptus* genomics and transcriptomics. IUFRO Tree Biotechnology Conference; 2011 2011; Arraial d'Ajuda, Bahia, Brazil: BMC Proceedings.
31. Odrionitz F, Pillmann H, Keller O, Waack S, Kollmar M. WebScipio: an online tool for the determination of gene structures using protein sequences. *BMC Genomics*. 2008; 9:422. 1471-2164-9-422 [pii] doi: [10.1186/1471-2164-9-422](https://doi.org/10.1186/1471-2164-9-422) PubMed PMID: [18801164](https://pubmed.ncbi.nlm.nih.gov/18801164/); PubMed Central PMCID: [PMCPMC2644328](https://pubmed.ncbi.nlm.nih.gov/PMC2644328/).
32. Jaglo KR, Kleff S, Amundsen KL, Zhang X, Haake V, Zhang JZ, et al. Components of the Arabidopsis C-repeat/dehydration-responsive element binding factor cold-response pathway are conserved in *Brassica napus* and other plant species. *Plant Physiology*. 2001; 127(3):910–7. PMID: [11706173](https://pubmed.ncbi.nlm.nih.gov/11706173/)
33. Navarro M, Marque G, Ayax C, Keller G, Borges JP, Marque C, et al. Complementary regulation of four *Eucalyptus* CBF genes under various cold conditions. *J Exp Bot*. 2009; 60(9):2713–24. erp129 [pii] doi: [10.1093/jxb/erp129](https://doi.org/10.1093/jxb/erp129) PubMed PMID: [19457981](https://pubmed.ncbi.nlm.nih.gov/19457981/); PubMed Central PMCID: [PMCPMC2692017](https://pubmed.ncbi.nlm.nih.gov/PMC2692017/).
34. Kapustin Y, Souvorov A, Tatusova T, Lipman D. Splign: algorithms for computing spliced alignments with identification of paralogs. *Biol Direct*. 2008; 3:20. 1745-6150-3-20 [pii] doi: [10.1186/1745-6150-3-20](https://doi.org/10.1186/1745-6150-3-20) PubMed PMID: [18495041](https://pubmed.ncbi.nlm.nih.gov/18495041/); PubMed Central PMCID: [PMCPMC2440734](https://pubmed.ncbi.nlm.nih.gov/PMC2440734/).
35. Grattapaglia D, Vaillancourt RE, Shepherd M, Thumma BR, Foley W, Külheim C, et al. Progress in Myrtaceae genetics and genomics: *Eucalyptus* as the pivotal genus. *Tree Genetics & Genomes*. 2012; 8:463–508.
36. Galiba G, Vagujfalvi A, Li CX, Soltész A, Dubcovsky J. Regulatory genes involved in the determination of frost tolerance in temperate cereals. *Plant Sci*. 2009; 176(1):12–9. doi: [10.1016/j.plantsci.2008.09.016](https://doi.org/10.1016/j.plantsci.2008.09.016) PubMed WOS:000261551900002.
37. Medina J, Catalá R, Salinas J. The CBFs: three arabidopsis transcription factors to cold acclimate. *Plant Sci*. 2011; 180(1):3–11. S0168-9452(10)00187-1 [pii] doi: [10.1016/j.plantsci.2010.06.019](https://doi.org/10.1016/j.plantsci.2010.06.019) PubMed PMID: [21421341](https://pubmed.ncbi.nlm.nih.gov/21421341/).
38. Larkin MA, Blackshields G, Brown NP, Chenna R, McGettigan PA, McWilliam H, et al. Clustal W and Clustal X version 2.0. *Bioinformatics*. 2007; 23(21):2947–8. btm404 [pii] doi: [10.1093/bioinformatics/btm404](https://doi.org/10.1093/bioinformatics/btm404) PubMed PMID: [17846036](https://pubmed.ncbi.nlm.nih.gov/17846036/).
39. Hall T. BioEdit: a user-friendly biological sequence alignment editor and analysis program for Windows 95/98/NT. *Nucl Acids Symp Ser*. 1999; 41:95–8.
40. Tamura K, Peterson D, Peterson N, Stecher G, Nei M, Kumar S. MEGA5: molecular evolutionary genetics analysis using maximum likelihood, evolutionary distance, and maximum parsimony methods. *Mol Biol Evol*. 2011; 28(10):2731–9. msr121 [pii] doi: [10.1093/molbev/msr121](https://doi.org/10.1093/molbev/msr121) PubMed PMID: [21546353](https://pubmed.ncbi.nlm.nih.gov/21546353/); PubMed Central PMCID: [PMCPMC3203626](https://pubmed.ncbi.nlm.nih.gov/PMC3203626/).
41. Felsenstein J. Evolutionary trees from DNA sequences: a maximum likelihood approach. *J Mol Evol*. 1981; 17(6):368–76. PubMed PMID: [7288891](https://pubmed.ncbi.nlm.nih.gov/7288891/).

42. El Kayal W, Navarro M, Marque G, Keller G, Marque C, Teulieres C. Expression profile of CBF-like transcriptional factor genes from *Eucalyptus* in response to cold. *J Exp Bot*. 2006; 57(10):2455–69. doi: [10.1093/jxb/erl019](https://doi.org/10.1093/jxb/erl019) PubMed WOS:000239389700030. PMID: [16816002](https://pubmed.ncbi.nlm.nih.gov/16816002/)
43. Navarro M, Marque G, Ayax C, Keller G, Borges JP, Marque C, et al. Complementary regulation of four *Eucalyptus* CBF genes under various cold conditions. *J Exp Bot*. 2009;60(9). doi: [10.1093/jxb/erp129](https://doi.org/10.1093/jxb/erp129) PubMed WOS:000266957900025.
44. Jones J, Dunsmuir P, Bedbrook J. High level expression of introduced chimeric genes in regenerated transformed plants. *The EMBO Journal*. 1985; 4:2411–8. PMID: [15929216](https://pubmed.ncbi.nlm.nih.gov/15929216/)
45. Livak KJ, Schmittgen TD. Analysis of relative gene expression data using real-time quantitative PCR and the 2-DDCT method. *Methods*. 2001; 25(4):402–8. PMID: [11846609](https://pubmed.ncbi.nlm.nih.gov/11846609/)
46. Myburg AA, Griffin AR, Sederoff RR, Whetten RW. Comparative genetic linkage maps of *Eucalyptus grandis*, *Eucalyptus globulus* and their F1 hybrid based on a double pseudo-backcross mapping approach. *Theoretical and Applied Genetics*. 2003; 107(6):1028–42. PubMed PMID: [12838392](https://pubmed.ncbi.nlm.nih.gov/12838392/).
47. Nakano T, Suzuki K, Fujimura T, Shinshi H. Genome-wide analysis of the ERF gene family in *Arabidopsis* and rice. *Plant Physiol*. 2006; 140(2):411–32. pp.105.073783 [pii] doi: [10.1104/pp.105.073783](https://doi.org/10.1104/pp.105.073783) PubMed PMID: [16407444](https://pubmed.ncbi.nlm.nih.gov/16407444/); PubMed Central PMCID: PMC1361313.
48. Zhuang J, Cai B, Peng RH, Zhu B, Jin XF, Xue Y, et al. Genome-wide analysis of the AP2/ERF gene family in *Populus trichocarpa*. *Biochem Biophys Res Commun*. 2008; 371(3):468–74. S0006-291X(08)00781-X [pii] doi: [10.1016/j.bbrc.2008.04.087](https://doi.org/10.1016/j.bbrc.2008.04.087) PubMed PMID: [18442469](https://pubmed.ncbi.nlm.nih.gov/18442469/).
49. Xu W, Li F, Ling L, Liu A. Genome-wide survey and expression profiles of the AP2/ERF family in castor bean (*Ricinus communis* L.). *BMC Genomics*. 2013; 14(1):785. Epub 2013/11/15. doi: [10.1186/1471-2164-14-785](https://doi.org/10.1186/1471-2164-14-785) PubMed PMID: [24225250](https://pubmed.ncbi.nlm.nih.gov/24225250/).
50. Chen Y, Yang J, Wang Z, Zhang H, Mao X, Li C. Gene Structures, Classification, and Expression Models of the DREB Transcription Factor Subfamily in *Populus trichocarpa*. *ScientificWorldJournal*. 2013; 2013:954640. Epub 2013/12/11. doi: [10.1155/2013/954640](https://doi.org/10.1155/2013/954640) PubMed PMID: [24324388](https://pubmed.ncbi.nlm.nih.gov/24324388/).
51. Zhou M-L, Tang Y-X, Wu Y-m. Genome-Wide Analysis of AP2/ERF Transcription Factor Family in *Zea Mays*. *Current Bioinformatics*. 2012; 7(3):324–32.
52. Dietz KJ, Vogel MO, Viehhauser A. AP2/EREBP transcription factors are part of gene regulatory networks and integrate metabolic, hormonal and environmental signals in stress acclimation and retrograde signalling. *Protoplasma*. 2010; 245(1–4):3–14. 10.1007/s00709-010-0142-8. PubMed PMID: [20411284](https://pubmed.ncbi.nlm.nih.gov/20411284/). doi: [10.1007/s00709-010-0196-7](https://doi.org/10.1007/s00709-010-0196-7)
53. Wang H, Moore MJ, Soltis PS, Bell CD, Brockington SF, Alexandre R, et al. Rosid radiation and the rapid rise of angiosperm-dominated forests. *Proc Natl Acad Sci U S A*. 2009; 106(10):3853–8. Epub 2009/02/19. doi: [10.1073/pnas.0813376106](https://doi.org/10.1073/pnas.0813376106) PubMed PMID: [19223592](https://pubmed.ncbi.nlm.nih.gov/19223592/); PubMed Central PMCID: PMC2644257.
54. Myburg A, Grattapaglia D, Tuskan G, Jenkins J, Schmutz J, Mizrahi E, et al. The *Eucalyptus grandis* Genome Project: Genome and transcriptome resources for comparative analysis of woody plant biology. *BMC Proceedings*. 2011; 5(Suppl 7):I20. PubMed doi: [10.1186/1753-6561-5-S7-I20](https://doi.org/10.1186/1753-6561-5-S7-I20)
55. Song J, Liu J, Weng M, Huang Y, Luo L, Cao P, et al. Cloning of galactinol synthase gene from *Ammopiptanthus mongolicus* and its expression in transgenic *Photinia serrulata* plants. *Gene*. 2013; 513(1):118–27. doi: [10.1016/j.gene.2012.10.058](https://doi.org/10.1016/j.gene.2012.10.058) PubMed PMID: [23116941](https://pubmed.ncbi.nlm.nih.gov/23116941/).
56. Xu ZS, Chen M, Li LC, Ma YZ. Functions of the ERF transcription factor family in plants. *Botany-Botanique*. 2008; 86(9):969–77. doi: [10.1139/b08-041](https://doi.org/10.1139/b08-041) PubMed WOS:000259575700001.
57. Lee SJ, Cho DI, Kang JY, Kim SY. An ARIA-interacting AP2 domain protein is a novel component of ABA signaling. *Mol Cells*. 2009; 27(4):409–16. doi: [10.1007/s10059-009-0058-3](https://doi.org/10.1007/s10059-009-0058-3) PubMed PMID: [19390821](https://pubmed.ncbi.nlm.nih.gov/19390821/).
58. Lee SJ, Kang JY, Park HJ, Kim MD, Bae MS, Choi HI, et al. DREB2C interacts with ABF2, a bZIP protein regulating abscisic acid-responsive gene expression, and its overexpression affects abscisic acid sensitivity. *Plant Physiol*. 2010; 153(2):716–27. doi: [10.1104/pp.110.154617](https://doi.org/10.1104/pp.110.154617) PubMed PMID: [20395451](https://pubmed.ncbi.nlm.nih.gov/20395451/); PubMed Central PMCID: PMC2879808.
59. Zhang W, Zou A, Miao J, Yin Y, Tian R, Pang Y, et al. LeERF-1, a novel AP2/ERF family gene within the B3 subcluster, is down-regulated by light signals in *Lithospermum erythrorhizon*. *Plant Biol (Stuttg)*. 2011; 13(2):343–8. Epub 2011/02/12. doi: [10.1111/j.1438-8677.2010.00375.x](https://doi.org/10.1111/j.1438-8677.2010.00375.x) PubMed PMID: [21309981](https://pubmed.ncbi.nlm.nih.gov/21309981/).
60. Tong Z, Hong B, Yang Y, Li Q, Ma N, Ma C, et al. Overexpression of two chrysanthemum DgDREB1 group genes causing delayed flowering or dwarfism in *Arabidopsis*. *Plant Mol Biol*. 2009; 71(1–2):115–29. doi: [10.1007/s11103-009-9513-y](https://doi.org/10.1007/s11103-009-9513-y) PubMed PMID: [19544047](https://pubmed.ncbi.nlm.nih.gov/19544047/).
61. Tayeh N, Bahrman N, Sellier H, Bluteau A, Blassiau C, Fourment J, et al. A tandem array of CBF/DREB1 genes is located in a major freezing tolerance QTL region on *Medicago truncatula* chromosome

6. BMC Genomics. 2013; 14:814. Epub 2013/11/23. doi: [10.1186/1471-2164-14-814](https://doi.org/10.1186/1471-2164-14-814) PubMed PMID: [24261852](https://pubmed.ncbi.nlm.nih.gov/24261852/).
62. Lin H, Zhu W, Silva JC, Gu X, Buell CR. Intron gain and loss in segmentally duplicated genes in rice. *Genome Biol.* 2006; 7(5):R41. gb-2006-7-5-r41 [pii] doi: [10.1186/gb-2006-7-5-r41](https://doi.org/10.1186/gb-2006-7-5-r41) PubMed PMID: [16719932](https://pubmed.ncbi.nlm.nih.gov/16719932/); PubMed Central PMCID: PMCPMC1779517.
63. Duarte JM, Cui LY, Wall PK, Zhang Q, Zhang XH, Leebens-Mack J, et al. Expression pattern shifts following duplication indicative of subfunctionalization and neofunctionalization in regulatory genes of *Arabidopsis*. *Molecular Biology and Evolution.* 2006; 23(2):469–78. doi: [10.1093/molbev/msj051](https://doi.org/10.1093/molbev/msj051) PubMed WOS:000234718800023. PMID: [16280546](https://pubmed.ncbi.nlm.nih.gov/16280546/)
64. Sandve SR, Fjellheim S. Did gene family expansions during the Eocene-Oligocene boundary climate cooling play a role in Pooideae adaptation to cool climates? *Mol Ecol.* 2010; 19(10):2075–88. MEC4629 [pii] doi: [10.1111/j.1365-294X.2010.04629.x](https://doi.org/10.1111/j.1365-294X.2010.04629.x) PubMed PMID: [20406386](https://pubmed.ncbi.nlm.nih.gov/20406386/).
65. Florence RG. *Ecology and silviculture of eucalypt forests*: Csiro; 1996.
66. Bowman DMJS. *Australian rainforests: islands of green in a land of fire* Cambridge University Press 2000.
67. Keller G, Cao P, San Clemente H, El Kayal W, Marque C, Teulières C. Transcript profiling combined with functional annotation of 2,662 ESTs provides a molecular picture of *Eucalyptus gunnii* cold acclimation. *Trees—Structure and Function.* 2013;1–23. doi: [10.1007/s00468-013-0918-5](https://doi.org/10.1007/s00468-013-0918-5)
68. Haake V, Cook D, Riechmann JL, Pineda O, Thomashow MF, Zhang JZ. Transcription factor CBF4 is a regulator of drought adaptation in *Arabidopsis*. *Plant Physiology.* 2002; 130(2):639–48. PMID: [12376631](https://pubmed.ncbi.nlm.nih.gov/12376631/)
69. Lawton-Rauh A. Evolutionary dynamics of duplicated genes in plants. *Mol Phylogen Evol.* 2003; 29(3):396–409. doi: [10.1016/j.ympev.2003.07.004](https://doi.org/10.1016/j.ympev.2003.07.004) PubMed WOS:000186738000003. PMID: [14615182](https://pubmed.ncbi.nlm.nih.gov/14615182/)
70. Xiao H, Tattersall EA, Siddiqua MK, Cramer GR, Nassuth A. CBF4 is a unique member of the CBF transcription factor family of *Vitis vinifera* and *Vitis riparia*. *Plant Cell and Environment.* 2008; 31(1):1–10. PubMed PMID: [17971068](https://pubmed.ncbi.nlm.nih.gov/17971068/).
71. Haake V, Cook D, Riechmann JL, Pineda O, Thomashow MF, Zhang JZ. Transcription factor CBF4 is a regulator of drought adaptation in *Arabidopsis*. *Plant Physiol.* 2002; 130(2):639–48. doi: [10.1104/pp.006478](https://doi.org/10.1104/pp.006478) PubMed PMID: [12376631](https://pubmed.ncbi.nlm.nih.gov/12376631/); PubMed Central PMCID: PMCPMC166593.
72. Chen J, Xia X, Yin W. Expression profiling and functional characterization of a DREB2-type gene from *Populus euphratica*. *Biochem Biophys Res Commun.* 2009; 378(3):483–7. doi: [10.1016/j.bbrc.2008.11.071](https://doi.org/10.1016/j.bbrc.2008.11.071) PMID: [19032934](https://pubmed.ncbi.nlm.nih.gov/19032934/)
73. Song Y, Chen Q, Ci D, Shao X, Zhang D. Effects of high temperature on photosynthesis and related gene expression in poplar. *BMC Plant Biol.* 2014; 14:111. Epub 2014/04/30. doi: [10.1186/1471-2229-14-111](https://doi.org/10.1186/1471-2229-14-111) PubMed PMID: [24774695](https://pubmed.ncbi.nlm.nih.gov/24774695/); PubMed Central PMCID: PMC4036403.
74. Martin HA. Cenozoic climatic change and the development of the arid vegetation in Australia. *Journal of Arid Environments.* 2006; 66(3):533–63. <http://dx.doi.org/10.1016/j.jaridenv.2006.01.009>.
75. Moss PT, Kershaw PA. The last glacial cycle from the humid tropics of northeastern Australia: comparison of a terrestrial and a marine record. *Palaeogeogr, Palaeoclimatol, Palaeoecol.* 2000; 155(1–2):155–76. doi: [10.1016/s0031-0182\(99\)00099-1](https://doi.org/10.1016/s0031-0182(99)00099-1)