



HAL
open science

Novel Position Controller for PMSM Based on State Feedback and Load Torque Feed-Forward

Zedong Zheng, Yongdong Li, Maurice Fadel

► **To cite this version:**

Zedong Zheng, Yongdong Li, Maurice Fadel. Novel Position Controller for PMSM Based on State Feedback and Load Torque Feed-Forward. *International Journal of Power Electronics and Drive Systems*, 2011, 11 (2), pp.140-147. 10.6113/JPE.2011.11.2.140 . hal-03561181

HAL Id: hal-03561181

<https://ut3-toulouseinp.hal.science/hal-03561181>

Submitted on 8 Feb 2022

HAL is a multi-disciplinary open access archive for the deposit and dissemination of scientific research documents, whether they are published or not. The documents may come from teaching and research institutions in France or abroad, or from public or private research centers.

L'archive ouverte pluridisciplinaire **HAL**, est destinée au dépôt et à la diffusion de documents scientifiques de niveau recherche, publiés ou non, émanant des établissements d'enseignement et de recherche français ou étrangers, des laboratoires publics ou privés.

Novel Position Controller for PMSM Based on State Feedback and Load Torque Feed-Forward

Zedong Zheng[†], Yongdong Li^{*}, and Maurice Fadel^{**}

^{†*} Dept. of Electrical Engineering, Tsinghua University, Beijing, China

^{**} LAPLACE Laboratoire Plasma et Conversion d'Energie, Toulouse, France

Abstract

In this paper, a novel position controller based on state feedback and feed-forward is proposed. Traditional position and speed controllers are replaced by a single controller with the position and speed as state feedbacks, and the position command and load torque as feed-forwards. The feedback and feed-forward gains are obtained by analytic modeling and design. The load torque, rotor speed and position are estimated by an observer based on a Kalman filter (KF) with a low resolution mechanical position sensor. Feed-forward compensation by an estimated load torque is used to improve the dynamic performance during load torque changes.

Key Words: Kalman filter, Load torque observer, PMSM, Position controller, State feedback

I. INTRODUCTION

Permanent magnet synchronous motors (PMSM) are widely used in servo systems because of their good characteristics, such as high power density, high torque to inertia ratio and high efficiency. In these systems, high performance position control is needed where the position controller is critical [1].

In motor control systems, speed and position controllers are usually designed by assuming that the load is constant. In reality, variations in load torque are big and they cause some fluctuations in rotor speed. In order to decrease speed fluctuations, feed-forward compensation of the load torque is usually needed [2], [3].

Also, a mechanical position sensor is needed to measure the rotor position and speed precisely for high performance controls. However, mechanical sensors with a high resolution are usually very expensive. Some control systems with low-resolution position sensors have been proposed in [4]–[7], but their performances are limited. Generally rotor speed is obtained by the differential of the measured position, which cannot be calculated in every control cycle if the resolution of the position sensor is limited. Moreover, the measured rotor speed usually contains a lot of noise. Filters with a small phase lag have been used to eliminate the noise but usually these filters are too complex to be used in practice [8].

Since torque sensors are still very expensive, load torque observers are often used to get load information. Some state observers [9], [10], as well as Kalman filter-based observers

[11], [12] have been proposed to estimate load torque.

In [16], [17], an analysis of different position controller structures has been done and a position controller based on PI+velocity control was proposed by adding a feed-forward term into a PID controller. In this controller, one of the feed-forward terms is obtained by the differential of the position command. As we know, differential calculations in controllers may cause some noise and instability. There are five controller parameters to be tuned. Some tuning methods for these parameters based on laboratory tests and industry experience are introduced in [17].

In this paper, a novel load torque observer based on a Kalman filter is proposed in order to estimate the load torque. A Kalman filter is a kind of adaptive and optimal observer. The parameter errors and measurement noises are both considered, so that the observer can reduce the effects of the parameters' inaccuracy, noises and errors caused by the quantized position sensor. The feedback gain matrix in a Kalman filter is updated based on the optimal control theory to make the observer both stable and convergent quickly [13].

Also, a novel position controller based on state feedback and state feed-forward is proposed. It replaces the traditional speed and position controllers by a single one and can achieve much better position control performance. Compared with the controllers proposed in [16] and [17], the difference of the position command is removed and a mathematic model of the proposed controller is built. Through theoretical analysis, all of the parameters of the proposed controller are derived based on control theory.

Simulation and experiment results are given to demonstrate the good performances of the control system. The rotor position can track the command value very well and there

Manuscript received Jun. 1, 2009; revised Nov. 29, 2010

[†] Corresponding Author: zheng99@mails.tsinghua.edu.cn

Tel: +86-10-62785481, Tsinghua University

^{*} Dept. of Electrical Engineering, Tsinghua University, China

^{**} LAPLACE Laboratoire Plasma et Conversion d'Energie, France

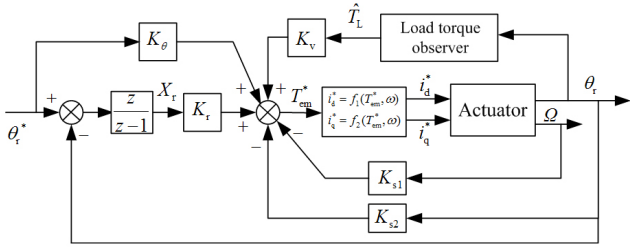

Fig. 1. Controller based on state feedback and feed-forward.

is nearly no overshoot in the position control.

II. POSITION CONTROLLER BASED ON STATE FEEDBACK

In traditional systems, two PID controllers are used to control the rotor speed and position, respectively. In fact, the rotor position and speed are mechanical variables with almost the same time constant. However, a differential part of the position controller corresponds to the rotor speed. As a result, these two controllers can be combined into a single one.

The novel position controller based on state feedback and feed-forward is adopted as shown in Fig.1, where the traditional position and speed controllers are replaced by a single one. The actuator means the current controllers, the inverters and the motors.

In this controller, integration can eliminate the position control errors. The estimated rotor position and speed are used as feedbacks through the coefficients K_{s1} and K_{s2} . The position command is used for feed-forward compensation through the coefficient K_θ . The estimated load torque is used for feed-forward compensation through K_v . The output of the controller is the electromagnetic torque command:

$$T_{em}^*(k) = -K_{s1}\Omega(k) - K_{s2}\theta_r(k) + K_r X_r(k) + K_\theta \theta_r^*(k) + K_v \hat{T}_L(k). \quad (1)$$

The values of the five feedback and feed-forward gains can be obtained by the expectation of the root locus with the target of eliminating the effect of the load torque changes.

The movement equations of the PMSM are shown in (2).

$$\begin{bmatrix} \dot{\Omega} \\ \dot{\theta}_r \end{bmatrix} = \begin{bmatrix} -\frac{f}{J} & 0 \\ 1 & 0 \end{bmatrix} \begin{bmatrix} \Omega \\ \theta_r \end{bmatrix} + \begin{bmatrix} \frac{1}{J} \\ 0 \end{bmatrix} T_{em} + \begin{bmatrix} -\frac{1}{J} \\ 0 \end{bmatrix} T_L. \quad (2)$$

Here Ω is the mechanical angular speed, f is the coefficient of friction, J is the inertia, T_{em} is the electromagnetic torque, T_L is the load torque, θ_r is the mechanical rotor position.

The discrete form of (2) can be written as:

$$\begin{bmatrix} \Omega(k+1) \\ \theta_r(k+1) \end{bmatrix} = F_m \begin{bmatrix} \Omega(k) \\ \theta_r(k) \end{bmatrix} + H_t T_{em}(k) - H_t T_L(k) \quad (3)$$

where:

$$F_m = e^{A \cdot T_m} = \begin{bmatrix} \lambda & 0 \\ \frac{1}{J}(1-\lambda) & 1 \end{bmatrix} = \begin{bmatrix} F_{m11} & 0 \\ F_{m21} & 1 \end{bmatrix} \quad (4a)$$

$$H_t = \begin{bmatrix} \frac{1}{J}(1-\lambda) \\ \frac{1}{J}(T_m - \frac{1}{J}(1-\lambda)) \end{bmatrix} = \begin{bmatrix} H_{t1} \\ H_{t2} \end{bmatrix} \quad (4b)$$

with: $\lambda = \exp(-\frac{f}{J}T_m)$, T_m is the position control period.

Suppose that the current control loop's response is quick enough, then we will have:

$$T_{em} = T_{em}^*. \quad (5)$$

If the output of the integration X_r is considered as a variable, the state equation of the controller can be written as:

$$\begin{bmatrix} \Omega(k+1) \\ \theta_r(k+1) \\ X_r(k+1) \end{bmatrix} = F_{bf} \begin{bmatrix} \Omega(k) \\ \theta_r(k) \\ X_r(k) \end{bmatrix} + \begin{bmatrix} H_{t1}K_\theta \\ H_{t2}K_\theta \\ 1 \end{bmatrix} \theta_r^*(k) - \begin{bmatrix} H_{t1} \\ H_{t2} \\ 0 \end{bmatrix} T_L(k) + \begin{bmatrix} H_{t1}K_v \\ H_{t2}K_v \\ 0 \end{bmatrix} \hat{T}_L(k). \quad (6)$$

The system's dynamic matrix is:

$$F_{bf} = \begin{bmatrix} F_{m11} - H_{t1}K_{s1} & -H_{t1}K_{s2} & H_{t1}K_r \\ F_{m21} - H_{t2}K_{s2} & 1 - H_{t2}K_{s1} & H_{t2}K_r \\ 0 & -1 & 1 \end{bmatrix}. \quad (7)$$

If the expected poles are $(z - p_{bf})^3$ with $p_{bf} = \exp(-T_m \omega_{bf})$, ω_{bf} is selected by the cut-off frequency of the controller.

Then we can obtain:

$$K_r = \frac{(1 - p_{bf})^2}{F_{m21}H_{t1} - F_{m11}H_{t2} + H_{t2}}. \quad (8a)$$

$$K_{s1} = \left(F_{m11} - p_{bf}^3 + (F_{m21}H_{t1} - F_{m11}H_{t2}) \cdot \left(\frac{2 + F_{m11} - 3p_{bf}}{H_{t2}} - K_r \right) \right) \cdot \left(\frac{H_{t2}}{H_{t1}(F_{m21}H_{t1} - F_{m11}H_{t2} + H_{t2})} \right). \quad (8b)$$

$$K_{s2} = \frac{2 + F_{m11} - 3p_{bf} - H_{t1}K_{s1}}{H_{t2}}. \quad (8c)$$

Suppose that the load torque can be measured or estimated very well, then there are:

$$\begin{bmatrix} \Omega(k+1) \\ \theta_r(k+1) \\ X_r(k+1) \end{bmatrix} = F_{bf} \begin{bmatrix} \Omega(k) \\ \theta_r(k) \\ X_r(k) \end{bmatrix} + \begin{bmatrix} H_{t1}K_\theta \\ H_{t2}K_\theta \\ 1 \end{bmatrix} \theta_r^*(k) + \begin{bmatrix} H_{t1}K_v - H_{t1} \\ H_{t2}K_v - H_{t2} \\ 0 \end{bmatrix} T_L(k). \quad (9)$$

If the effects of the load torque are expected to be compensated completely, that is to say, the sum of the last term in (9) is expected to be zero, we can select:

$$K_v = 1. \quad (10)$$

Then (9) can be simplified as follows:

$$\begin{bmatrix} \Omega(k+1) \\ \theta_r(k+1) \\ X_r(k+1) \end{bmatrix} = F_{bf} \begin{bmatrix} \Omega(k) \\ \theta_r(k) \\ X_r(k) \end{bmatrix} + \begin{bmatrix} H_{t1}K_\theta \\ H_{t2}K_\theta \\ 1 \end{bmatrix} \theta_r^*(k). \quad (11)$$

Because the rotor position is the final control target, the transfer function from the position reference to the rotor position is:

$$\frac{\theta_r(z)}{\theta_r^*(z)} = \frac{K_\theta(z-1 + \frac{K_r}{K_\theta}) \cdot (H_{t2} \cdot z - F_{m11} \cdot H_{t2}F_{m21} \cdot H_{t1})}{\det[z \cdot I - F_{bf}]}. \quad (12)$$

A pole of the system can be compensated by K_θ in order to reduce the orders of the system and to improve the dynamic response. So K_θ can be selected as:

$$K_\theta = \frac{K_r}{1 - p_{bf}}. \quad (13)$$

In order to analyze the position trace error under the proposed controller, the position reference is supposed to be a ramp:

$$\theta_r^*(k+1) - \theta_r^*(k) = \theta_r(k+1) - \theta_r(k) = k \cdot T_m \quad (14)$$

where k is a coefficient.

And finally the motor will reach the steady state:

$$T_{em}^*(k+1) - T_{em}^*(k) = 0 \quad (15a)$$

$$\Omega(k+1) = \Omega(k) \quad (15b)$$

that is to say:

$$\begin{aligned} &(-K_{s2}\theta_r(k+1) + K_r \cdot X_r(k+1) + K_\theta\theta_r^*(k+1)) \\ &- (-K_{s2}\theta_r(k) + K_r \cdot X_r(k) + K_\theta\theta_r^*(k)) = 0. \end{aligned} \quad (16)$$

Define the position control error:

$$\varepsilon_\theta = \theta_r^*(k) - \theta_r(k) = \theta_r^*(k+1) - \theta_r(k+1) \quad (17)$$

then the position trace error can be obtained by the following:

$$\varepsilon_\theta = \frac{K_{s2} - K_\theta}{K_r} \cdot k \cdot T_m. \quad (18)$$

It is shown that the position trace error is generally not zero. If we select $K_\theta = K_{s2}$, this error can be zero, but in this case, the controller will become an ordinary PID controller.

III. LOAD TORQUE OBSERVER BASED ON A KALMAN FILTER

By the former introduction, the load torque is needed for feed-forward compensation to get good performance. However, the measurement of load torque is very difficult and expensive. Therefore, the on-line estimation of load torque is a very good solution.

Load torque is supposed to change very slowly when compared with the rotor speed and the position, that means:

$$\dot{T}_L = 0. \quad (19)$$

Based on (2), with the rotor speed, position and load torque as state variables, the state equations of the observer will be:

$$\begin{bmatrix} \dot{\Omega} \\ \dot{\theta}_r \\ \dot{T}_L \end{bmatrix} = \begin{bmatrix} -\frac{f}{J} & 0 & -\frac{1}{J} \\ 1 & 0 & 0 \\ 0 & 0 & 0 \end{bmatrix} \cdot \begin{bmatrix} \Omega \\ \theta_r \\ T_L \end{bmatrix} + \begin{bmatrix} \frac{1}{J} \\ 0 \\ 0 \end{bmatrix} T_{em}. \quad (20)$$

Rewriting (20) in the form of a matrix:

$$\dot{\mathbf{x}} = \mathbf{A}\mathbf{x} + \mathbf{G} \cdot \mathbf{u} \quad (21)$$

with the output equation:

$$\mathbf{y} = \theta_r = \mathbf{C} \cdot \mathbf{x} \quad (22)$$

where:

$$\mathbf{x} = [\Omega \quad \theta_r \quad T_L]^T \quad (23)$$

$$\mathbf{C} = [0 \quad 1 \quad 0]. \quad (24)$$

The discrete form of the state equation by the Euler method will be:

$$\mathbf{x}_k = \mathbf{x}_{k-1} + (\mathbf{A}\mathbf{x}_{k-1} + \mathbf{G}\mathbf{u}_{k-1})T_s. \quad (25)$$

Define:

$$\mathbf{F} = \mathbf{I} + \mathbf{A}T_s = \begin{bmatrix} 1 - f \cdot T_s/J & 0 & -T_s/J \\ T_s & 1 & 0 \\ 0 & 0 & 1 \end{bmatrix} \quad (26)$$

$$\mathbf{B} = \mathbf{G} \cdot T_s = [T_s/J \quad 0 \quad 0]^T \quad (27)$$

where T_s is the sampling time. \mathbf{I} is the unit matrix.

Considering the effects of noises and disturbance, the discrete state equation can be written as:

$$\mathbf{x}_k = \mathbf{F}_{k-1}\mathbf{x}_{k-1} + \mathbf{B}_{k-1}\mathbf{u}_{k-1} + \mathbf{w} \quad (28a)$$

$$\mathbf{y}_k = \mathbf{C} \cdot \mathbf{x}_k + \mathbf{v} \quad (28b)$$

where \mathbf{w} and \mathbf{v} are random disturbances. In fact \mathbf{w} is the process noise which stands for the error of the parameters and \mathbf{v} is the measurement noise which stands for the errors in the measurement and sampling.

The noise covariance matrixes can be defined as follows:

$$\mathbf{Q} = \text{cov}(\mathbf{w}) = E\{\mathbf{w}\mathbf{w}^T\} \quad (29a)$$

$$\mathbf{R} = \text{cov}(\mathbf{v}) = E\{\mathbf{v}\mathbf{v}^T\}. \quad (29b)$$

In practice, the matrixes \mathbf{Q} and \mathbf{R} are adjusted by experience as the statistical properties of noises are unknown.

The Kalman filter can be calculated by iteration as follows:

1. Compute the state ahead and the error covariance ahead.

$$\hat{\mathbf{x}}_k^- = \mathbf{F}_{k-1}\hat{\mathbf{x}}_{k-1} + \mathbf{B}_{k-1}\mathbf{u}_{k-1} \quad (30a)$$

$$\mathbf{P}_k^- = \mathbf{F}_k\mathbf{P}_{k-1}\mathbf{F}_k^T + \mathbf{Q}_{k-1}. \quad (30b)$$

2. Compute the Kalman gain.

$$\mathbf{K}_k = \mathbf{P}_k^- \mathbf{C}_k^T (\mathbf{C}_k \mathbf{P}_k^- \mathbf{C}_k^T + \mathbf{R}_k)^{-1}. \quad (30c)$$

3. Update the estimation with the measurement.

$$\hat{\mathbf{x}}_k = \hat{\mathbf{x}}_k^- + \mathbf{K}_k (\mathbf{y}_k - \mathbf{C} \cdot \hat{\mathbf{x}}_k^-). \quad (30d)$$

4. Update the error covariance matrix.

$$\mathbf{P}_k = (\mathbf{I} - \mathbf{K}_k \mathbf{C}_k) \mathbf{P}_k^-. \quad (30e)$$

Matrix \mathbf{P} is the error covariance of the estimation.

$$\mathbf{P}_{k|k} = E\{\mathbf{e}_k \cdot \mathbf{e}_k^T\} = \sum_{i=1}^n E\{[\mathbf{x}_i - \hat{\mathbf{x}}_i][\mathbf{x}_i - \hat{\mathbf{x}}_i]^T\}. \quad (31)$$

$E\{\cdot\}$ is the computation of the expectation value.

TABLE I
PARAMETERS OF THE MOTOR

Parameters	Values
Rotor magnet flux ψ_d	0.153093 wb
Inertia J	0.07 Kg · m ²
Coefficient of friction f	0.0826 N · m/(rad/s)
Number of pole pairs p_n	4
Points of position sensor per cycle	256 points

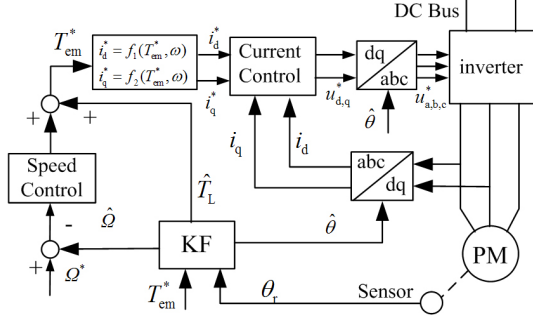

Fig. 2. Block diagram of the system.

IV. SIMULATION RESULTS

To verify the performance of the load torque observer and the novel position controller, simulations have been carried out with MATLAB. The sampling frequency is set to 10 K Hz. A surface mounted PMSM is adopted and the parameters are shown in Table I.

First a normal speed control system is simulated. Generally the design of a speed PID regulator is done by assuming a load torque constant or zero. If the load torque changes, the performance of the speed PID regulator will be affected. If the estimated load torque is added as compensation of the reference torque at the output of the speed PI regulator, the control performance will be greatly improved.

The normal speed control system is shown in Fig. 1 where the estimated rotor speed and the position by the Kalman filter are used instead of the values measured directly by a position sensor, and the estimated load torque is used as a feed-forward compensation. A rotor flux oriented vector control system is used for the high performance control of a PMSM. The d-axis current is controlled to be zero in order to get the maximum torque. Simulations are carried out to verify the performance of the proposed observer and the feed-forward of the estimated load torque.

In a Kalman filter, the initial values of the matrix \mathbf{P} , \mathbf{Q} and \mathbf{R} matrixes are set as follows:

$$\mathbf{P}_{0|0} = \begin{bmatrix} 1.0 & & \\ & 1.0 & \\ & & 1.0 \end{bmatrix}, \mathbf{Q} = \begin{bmatrix} 0.1 & & \\ & 0.1 & \\ & & 50.0 \end{bmatrix},$$

$$\mathbf{R} = [50.0].$$

Since the actual noises are unknown, a covariance matrix can only be obtained by empiric adjustment. By simulation, it can be seen that a covariance matrix can be chosen in a wide range that does not influence the stability of the system. As a result, these covariance matrixes can be selected approximately.

The positions measured by a position sensor directly and estimated by a Kalman filter are shown in Fig. 3. Compared

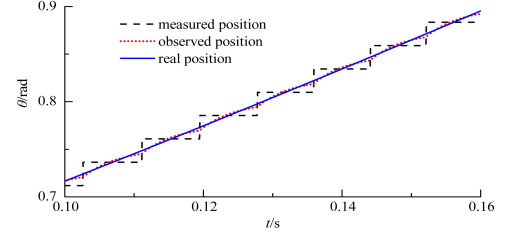

Fig. 3. Measured, estimated and real position.

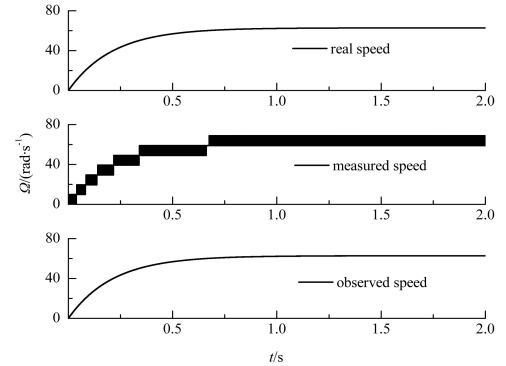

Fig. 4. Real, measured and estimated speed.

with the real position, the estimated position is more precise than the measured one with a low resolution mechanical sensor. It can be considered that the measured speed and position are filtered.

Since the resolution of the sensor is very low (256P/R), the measured speed is calculated every 50 periods (5ms) by using the traditional method (differential of the position), which is to calculate the rotor speed by (32). This can cause some lag in the speed.

$$\Omega = (\theta_r(k) - \theta_r(k - 50)) / (50 \cdot T_s). \quad (32)$$

The real speed is shown in Fig. 4, while the measured and estimated speeds are also shown. It is obvious that the speed obtained by the differential of the position contains a lot of noise and error. Although a low-pass filter can be used to eliminate the noise, this will result in another phase lag.

To prevent the windup effect made by the over-saturation of the integration in the position controller, an anti-windup operation is adopted at the output of the controller [14,15]. The load torque, rotor position and speed are estimated by a Kalman filter through the measured position. The whole position control system is shown in Fig. 5.

Simulations have been carried out to validate the performance of the proposed controller. The parameters of the motor are the same to those shown in Table I. The control cycle of the position is $T_m = 1\text{ms}$.

When the cut-off frequency F_c is set to 10π rad/s, a satisfactory position control result can be obtained as shown in Fig. 6

When the cut-off frequency is set to 1.6π rad/s, the position control result will be a bit slower as shown in Fig. 7. The

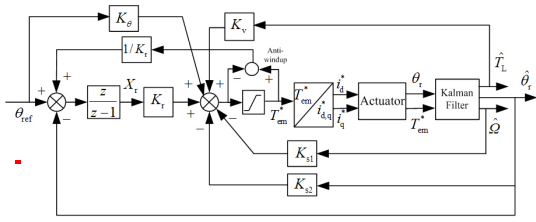

Fig. 5. Controller with anti-windup operation.

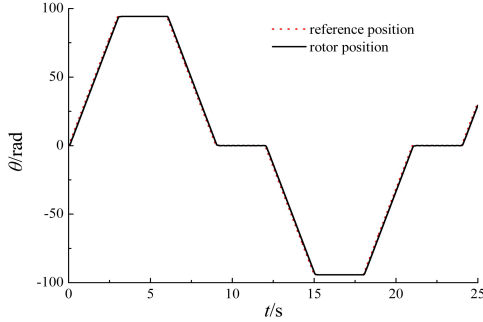

Fig. 6. Position control results with $F_c = 10\pi$ rad/s.

position trace error is shown in Fig. 8. The value is the same as the one calculated by (18).

If we select $K_\theta = K_{s2}$, the position control result is shown in Fig. 9. Because the position command feed-forward gain and the position feedback gain are the same, the feedback and the feed-forward compose a proportional part of a normal PID controller. It is obvious that the overshoot is larger than before because the controller becomes an ordinary PID controller.

If the position reference is a step, the position control result is shown in Fig. 10 when there is no anti-windup operation with the same controller gains. The result with the anti-windup operation is shown in Fig. 11. Obviously the anti-windup operation can greatly improve the control performance. These two figures are listed to compare the effect of the anti-windup action, despite the fact that the result of Fig. 10 can be improved by the adjustment of the controller gains.

V. EXPERIMENTAL RESULTS

Experiments have been done on a platform with a TMS320C6711 DSP as a CPU controller. The parameters of the motor are the same to these shown in Table I. In fact, the real inertia and friction coefficient parameters in Table I are not known precisely, they are calculated by the electromagnetic torque and the measured rotor speed during several accelerations when the motor is controlled by a vector control method. Although these imprecise parameters are used for the observer and the controller, the system is still stable. So the observer and the controller are not very sensitive to parameter errors.

The initial values of the matrix \mathbf{P} , \mathbf{Q} and \mathbf{R} matrixes are set as follows:

$$\mathbf{P}_{0|0} = \begin{bmatrix} 1.0 & & & \\ & 1.0 & & \\ & & 1.0 & \\ & & & 1.0 \end{bmatrix}, \mathbf{Q} = \begin{bmatrix} 0.1 & & & \\ & 0.1 & & \\ & & & 10.0 \end{bmatrix}, \\ \mathbf{R} = [50.0].$$

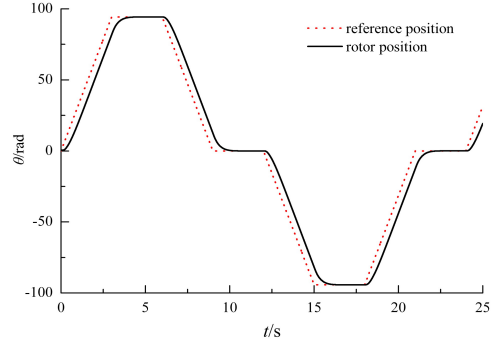

Fig. 7. Position control results with $F_c = 1.6\pi$ rad/s.

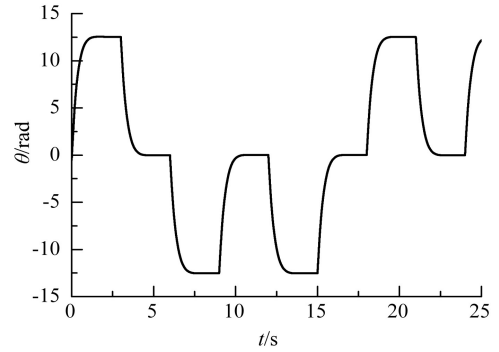

Fig. 8. Position trace error.

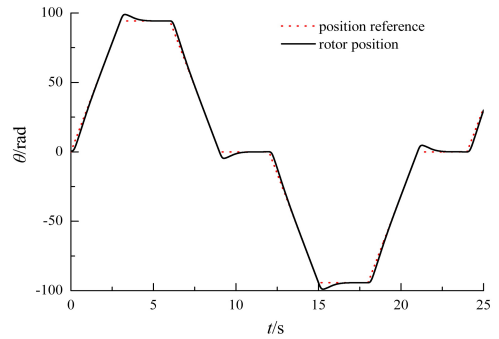

Fig. 9. Position control with PID controller.

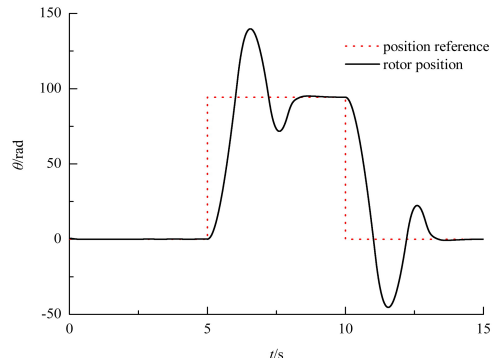

Fig. 10. Step position response without anti-windup operation.

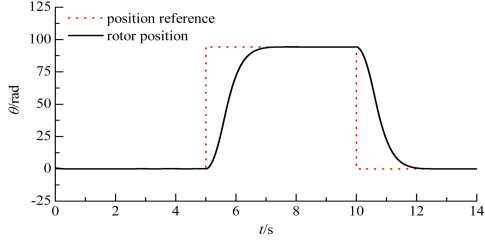

Fig. 11. Step position response with anti-windup operation.

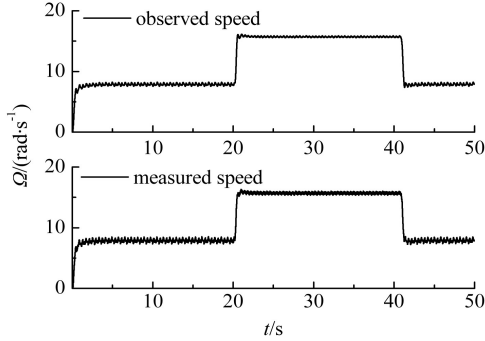

Fig. 12. Estimated rotor speed.

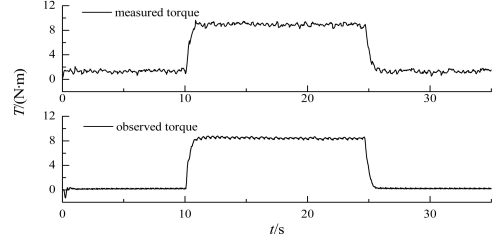

Fig. 13. Estimated load torque.

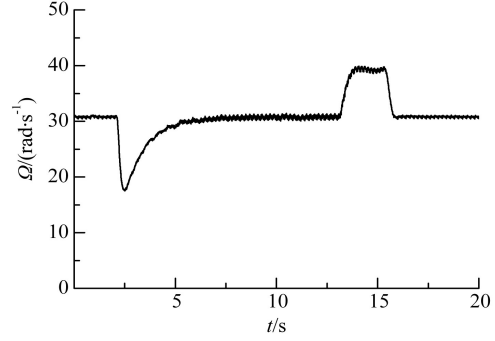

Fig. 14. Speed control without load torque feed-forward compensation.

The covariance matrixes are adjusted slightly and a satisfying performance can be obtained. Therefore, the artificial adjustment of the parameters for the Kalman filter proposed in this paper is very easy.

The estimated speed and the load torque are shown in Fig. 12 and Fig. 13. It can be seen that the estimated speed contains less noise than the measured one. The estimated load torque can track the measured value very well in both the static and dynamic states.

Under the same load torque impacts, the speed responses of the systems with and without the feed-forward compensations of the estimated load torque are shown in Fig. 14 and Fig. 15. It can be seen that the feed-forward compensation can greatly eliminate the speed fluctuations during load variations and thus greatly improve the speed dynamic response.

The decrease of rotor speed fluctuations under the feed-forward compensation by estimated load torque can also reflect the accuracy and the dynamic track speed of the load torque estimation.

With an observer based on a Kalman filter, the proposed position controller based on state feedback and feed-forward is realized on the experimental platform. In the experiments, the control period of the position is $T_m = 1$ ms and the parameters of the controller are selected as follows:

$$\omega_{bf} = 1.6\pi \text{rad/s.}$$

$$p_{bf} = \exp(-T_m \omega_{bf}) = 0.9950.$$

$$K_v = 1.0, K_r = 0.0088, K_{s1} = 0.9683, K_{s2} = 5.278, K_\theta = 1.7608.$$

With the novel position controller, the position control performance is shown in Fig. 16 where a load torque impact is added at about 40s. It can be seen that the real position

can track the position command very well and that there is nearly no influence on position control as a result of load variation. The corresponding rotor speed is shown in Fig. 17. The estimated load torque during load torque impact is shown in Fig. 18. The direction of the load torque is determined by the directions of the speed and the acceleration of the motor. The effects of load torque changes are compensated for completely. It is proven that the proposed state controller is very suitable for servo systems. When the position command is a step, the rotor position control result is shown in Fig. 19. It can be seen that the anti-windup operation can greatly reduce the overshoot of the position control and improve the control performance.

VI. CONCLUSION

A novel load torque observer based on a Kalman filter is proposed in this paper. The measured rotor position by a low resolution position sensor is used as the input of the Kalman filter to estimate the load torque, rotor position and rotor speed. The estimated position and speed are more precise than the directly measured ones, and the cost of the servo systems can be decreased. The estimated load torque by the Kalman filter can be used as a feed-forward compensation to improve the control performance during load torque changes. Based on the estimated values, a novel position controller based on state feedback and load torque feed-forward is formed in which the rotor position and speed are used as state feedback while the load torque and command position are used as state feed-forward. With the novel state controller, the complexity of the servo systems is greatly reduced and very good position control performance is obtained.

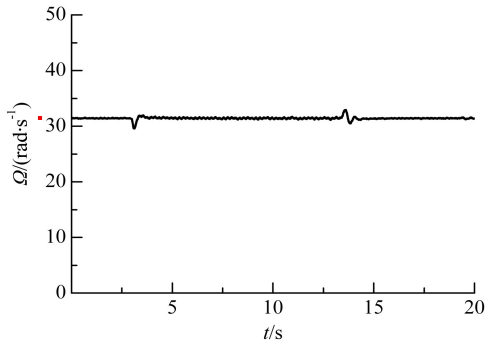

Fig. 15. Speed control with load torque feed-forward compensation.

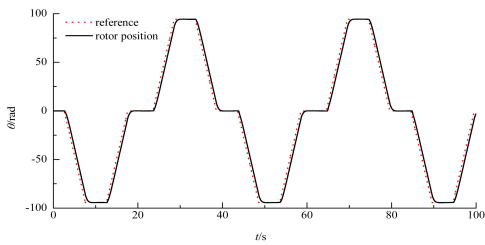

Fig. 16. Rotor position control performance for ramp reference.

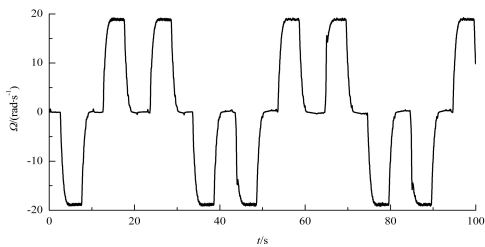

Fig. 17. Rotor speed during position control.

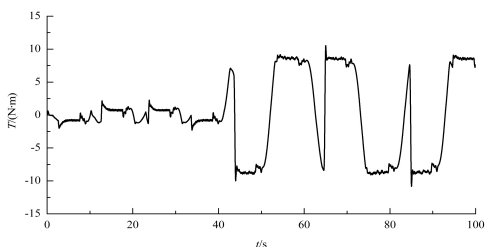

Fig. 18. Estimated load torque during position control.

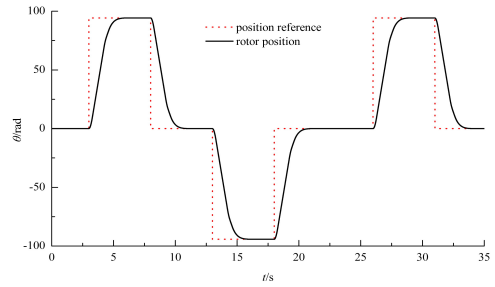

Fig. 19. Position control result when position reference is pulse.

REFERENCES

- [1] K.-K. Shyu, C.-K. Lai, Y.-W. Tsai, and D.-I. Yang, "A newly robust controller design for the position control of permanent-magnet synchronous motor," *IEEE Trans. Ind. Electron.*, Vol. 49, No. 3, pp. 558-565, Jun. 2002.
- [2] Y. Zhang, C. M. Akujobi, W. H. Ali, C. L. Tolliver, L.-S. Shieh, "Load disturbance resistance speed controller design for PMSM," *IEEE Trans. Ind. Electron.*, Vol. 53, No. 4, pp. 1198-1208, Jun. 2006.
- [3] M. Fadel, "Position control laws for electromechanical actuator," in *Proc. ICEMS '05*, Vol. 2, pp.1708-1713, Sep. 2005.
- [4] A. Bunte and S. Beineke, "High-performance speed measurement by suppression of systematic resolver and encoder errors," *IEEE Trans. Ind. Electron.*, Vol. 51, No. 1, pp. 49-53, Feb. 2004.
- [5] H.-W. Kim and S.-K. Sul, "A new motor speed estimator using Kalman filter in low-speed range," *IEEE Trans. Ind. Electron.*, Vol. 43, No. 4, pp. 498-504, Aug. 1996.
- [6] C.-W. Hung, C.-T. Lin, C.-W. Liu, and J.-Y. Yen, "A variable-sampling controller for brushless DC motor drives with low-resolution position sensors," *IEEE Trans. Ind. Electron.*, Vol. 54, No. 5, pp. 2846-2852, Oct. 2007.
- [7] M. Shigeo, S. Masayuki, and T. Yoji, "High-performance current drive for PMSM and SynRM with only low-resolution position sensor," *IEEE Trans. Ind. Appl.*, Vol. 39, No. 3, pp. 792-801, May/June. 2003.
- [8] S. J. Ovaska, "Improving the velocity sensing resolution of pulse encoders by FIR prediction," *IEEE Trans. Instrum. Meas.*, Vol. 40, No. 3, pp.657-658, Jun. 1991.
- [9] Y. A.-R. I. Mohamed, "A hybrid-type variable-structure instantaneous torque control with a robust adaptive torque observer for a high-performance direct-drive PMSM," *IEEE Trans. Ind. Electron.*, Vol. 54, No. 5, pp. 2491-2499, Oct. 2007.
- [10] Guchuan Zhu, L.-A. Dessaint, O. Akhrif, A. Kaddouri, "Speed tracking control of a permanent-magnet synchronous motor with state and load torque observer," *IEEE Trans. Ind. Electron.*, Vol. 47, No. 2, pp.346-355, Apr. 2000.
- [11] T.-J. Kweon and D.-S. Hyun, "High-performance speed control of electric machine using low-precision shaft encoder," *IEEE Trans. Power Electronics*, Vol. 14, No. 5, pp. 838-849, Sep. 1999.
- [12] X. Dianguo, W. Hong, S. Jingzhuo, "PMSM servo system with speed and torque observer," in *Proc. PESC '03*, Vol. 1, pp. 241-245, Jun. 2003.
- [13] S. Bolognani, L. Tubiana, and M. Zigliotto, "Extended kalman filter tuning in sensorless PMSM drives," *IEEE Trans. Ind. Appl.*, Vol. 39, No. 6, pp. 276-281, Nov./Dec. 2003.
- [14] D. Zhang, H. Li, and E. G. Collins, "Digital anti-windup PI controllers for variable-speed motor drives using FPGA and stochastic theory," *IEEE Trans. Power Electron.*, Vol.21, No. 5, pp.1496-1501, Sep. 2006.
- [15] H.-B. Shin, "New antiwindup PI controller for variable-speed motor drives," *IEEE Trans. Ind. Electron.*, Vol. 45, No. 3, pp. 445-450, Jun. 1998.
- [16] C. T. Johnson and R. D. Lorenz, "Experimental identification of friction and its compensation in precise, position controlled mechanisms," *IEEE Trans. Ind. Appl.*, Vol. 28, No. 6, pp.1392-1398, Nov./Dec. 1992.
- [17] G. Ellis, R. D. Lorenz, "Comparison of motion control loops for industrial applications," in *Proc. IAS'99*, Vol. 4, pp.2599-2605.



Zedong Zheng was born in Shandong Province, P.R. China in 1980. He received his B.S. in Electrical Engineering in 2003, from Tsinghua University, China, and his Ph.D. also in Electrical Engineering from Tsinghua University, China. He is currently a faculty member in the Department of Electrical Engineering, Tsinghua University. His research interests include power electronics converters and high performance motor control systems.



Maurice Fadel was born in Toulouse, France, in 1958. He received his Ph.D. from the Institut National Polytechnique (INP) de Toulouse France, in 1988. He is currently a Professor at the INP, Toulouse, France and an Assistant Leader at the Laboratoire Plasma et Conversion d'Energie (LAPLACE). His work concerns the modeling and control of electric systems.



Yongdong Li was born in Hebei Province, P.R. China in 1962. He received his B.S. in Electrical Engineering from the Harbin Institute of Technology, China, in 1982, and his M.S. and Ph.D. also in Electrical Engineering from the Institut National Polytechnique de Toulouse, France, in 1984 and 1987, respectively. He is currently a Professor in the Department of Electrical Engineering, Tsinghua University, Beijing. His research interests include power electronics, motor control and wind energy.