



HAL
open science

Observer Design for a three-cell chopper using a discrete-time model

Rédha Bensaid, Maurice Fadel, Thierry Meynard

► **To cite this version:**

Rédha Bensaid, Maurice Fadel, Thierry Meynard. Observer Design for a three-cell chopper using a discrete-time model. 3rd International Symposium on Advanced Electromechanical Motion Systems (ELECTROMOTION '99), Jul 1999, Patras, Greece. pp.689-694. hal-03556970

HAL Id: hal-03556970

<https://ut3-toulouseinp.hal.science/hal-03556970>

Submitted on 4 Feb 2022

HAL is a multi-disciplinary open access archive for the deposit and dissemination of scientific research documents, whether they are published or not. The documents may come from teaching and research institutions in France or abroad, or from public or private research centers.

L'archive ouverte pluridisciplinaire **HAL**, est destinée au dépôt et à la diffusion de documents scientifiques de niveau recherche, publiés ou non, émanant des établissements d'enseignement et de recherche français ou étrangers, des laboratoires publics ou privés.

OBSERVER DESIGN FOR A THREE-CELL CHOPPER USING A DISCRETE-TIME MODEL

R. Bensaid, M. Fadel, T. Meynard,

L.E.E.I – Laboratoire d'Electrotechnique et d'Electronique Industrielle,
Unité Mixte de Recherche, INPT – ENSEEIHT / CNRS,
B.P. 7122 – 2, rue Camichel – 31071 Toulouse Cedex 7 – France.
Tel. : 335-61-58-82-08, Fax. : 335-61-63-88-75,
E-mail: bensaid@leei.enseeiht.fr – fadel@leei.enseeiht.fr – meynard@leei.enseeiht.fr

Abstract - The multicell converters are very interesting in high voltage power conversion since the switching voltages are reduced considerably and the harmonic spectrum of the output signals are improved.

For closed-loop control purposes, measurements of state variables are required but are expensive to obtain directly especially when the cells number increase.

In order to avoid the voltage sensors in these converters, a full-order observer using the load current measurement, is presented here. Design of the observer is done for a three-cell chopper and is based on an exact discrete-time model.

Keywords: Multicell converter, Power electronics, Luenberger observer, Discrete-time model, Ackermann's formula.

1. INTRODUCTION

In the field of high voltage power conversion, a new multilevel topology has been introduced in the nineties : the multicell converters [1]. These converters are very interesting since they enable to reach high power / high voltage applications. With a phase-shift of $2\pi/p$ between the control signals and a switching frequency f_d , we obtain an output signal with harmonics at multiple of $p \times f_d$ if the capacitor voltage v_{Ck} ($k=1 \dots p-1$) are stabilized to kE/p (p is the number of cells). The switched voltage in the cells is thus reduced to E/p .

With this low switching voltage, the switches have lower conduction losses and can switch at higher frequency.

In p -cell converter, a closed loop control of the $p-1$ capacitor voltages may be used to maintain them to their optimal value kE/p when a fluctuation in the input voltage source appear.

Syntheses of different control laws have been proposed by several authors (see [2][3] for PWM control and [4] for a sliding mode approach) and require the state measurements.

In PWM control strategy, the control input given by the duty-cycle vector $\alpha = (\alpha_1, \alpha_2, \alpha_3)^T$, is set at the beginning of the switching period and remains constant until the beginning of the next switching period. In other words, the duty cycle is a discrete time variable. Then, it

is natural to think that the system itself is a discrete-time system.

Therefore, the first step in our procedure is to obtain a discrete time system that exactly reproduces the output of the continuous-time system at sampling time instants.

In order to reduce the sensors and the cost of these converters a state observer using the load current measurement is presented here. The design of this observer is based on a linear approach (Luenberger observer) and uses an exact discrete-time model.

It is also advisable to note that the average model of the three-cell converter is not observable when only the load current is measured [2].

2. THE DISCRETE-TIME MODEL

In this section, an exact discrete-time model for a three-cell chopper (figure 1) is obtained, assuming a fixed sampling time T_d (where T_d is the switching period) and a phase-shift of $2\pi/3$ between the control signals. Dead times are neglected and the switches are assumed to be perfect.

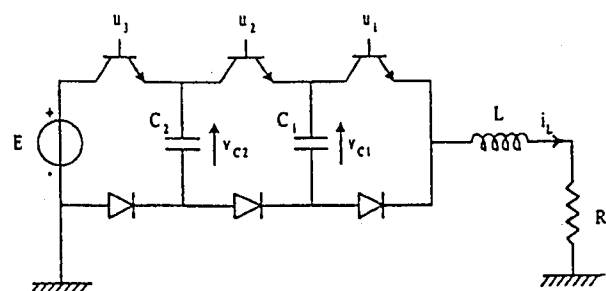

Figure 1. Structure of a three-cell buck chopper.

The instantaneous model of the chopper in the state space has the following description:

$$\begin{cases} \dot{x} = A(u) \cdot x + B(u) \cdot E \\ y = C \cdot x \end{cases} \quad (1)$$

where:

$$A(u) = \begin{bmatrix} 0 & 0 & \frac{u_2 - u_1}{C_1} \\ 0 & 0 & \frac{u_3 - u_2}{C_2} \\ \frac{u_1 - u_2}{L} & \frac{u_2 - u_3}{L} & -\frac{R}{L} \end{bmatrix}, B(u) = \begin{bmatrix} 0 \\ 0 \\ \frac{u_3}{L} \end{bmatrix}$$

$$C = [0 \ 0 \ 1], \quad x = (v_{C1}, v_{C2}, i_L)^T,$$

E the input voltage source and $u = (u_1, u_2, u_3)^T$ the control signal vector. The subscript T indicates the transpose of the associated vector.

In the following, we assume that the duty-cycles

$$\alpha_i = \frac{1}{T_d} \int_0^{T_d} u_i dt \text{ and the voltage source } E \text{ are constants}$$

during the time interval $[0, T_d]$.

It is possible to obtain the exact discrete-time model that relates the state vector at time $(k+1) \cdot T_d$ to the one at time $k \cdot T_d$.

In order to achieve this purpose, we have to solve the differential equation (1) and find the relation between $x(t_{j+1})$ and $x(t_j)$ for each sequence j ($j=1 \dots 7$) (figure 2).

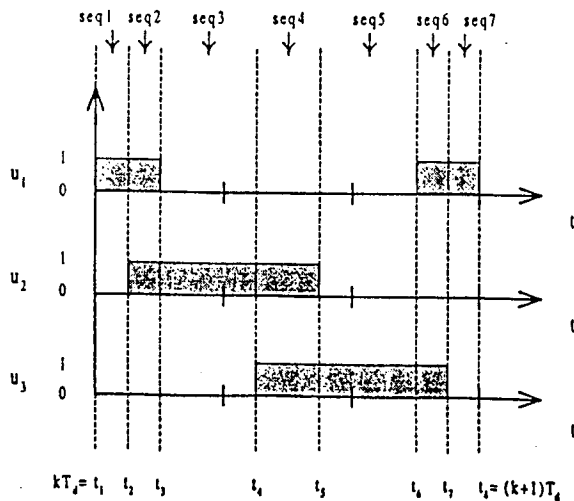

Figure 2. Control signals for a given duty-cycle vector

This relation is given by:

$$x(t_{j+1}) = F_j \cdot x(t_j) + G_j \cdot E \quad (2)$$

where:

$$\begin{cases} F_j = e^{A(\bar{u}^j) \cdot \Delta t_j} \\ G_j = \left[\int_{t_j}^{t_{j+1}} e^{A(\bar{u}^j) \cdot (t_{j+1} - \tau)} d\tau \right] \cdot B(\bar{u}^j) \end{cases}$$

By definition, during each sequence j , the control signal vector $u = (u_1, u_2, u_3)^T$ remains constant and is noted \bar{u}^j . For a given duty-cycle vector $\alpha = (\alpha_1, \alpha_2, \alpha_3)^T$, one can determine the duration $\Delta t_j = t_{j+1} - t_j$ and the control signal vector \bar{u}^j for each sequence.

Thus, the matrix F_j and the vector G_j depend only on the duty-cycle vector α , which is known at the beginning of each period T_d .

Using the notation:

$$\prod_{j=l_1}^{l_2} F_j = \begin{cases} F_{l_2} \cdot F_{l_2-1} \cdots F_{l_1} & , l_2 \geq l_1 \\ I_3 & , l_2 = l_1 - 1 \end{cases}$$

and defining:

$$\begin{cases} F(\alpha) = \prod_{j=1}^7 F_j \\ G(\alpha) = \sum_{l=1}^7 \left(\prod_{j=l+1}^7 F_j \right) \cdot G_l \end{cases}$$

the discrete-time model of the three-cell chopper can be written as:

$$\begin{cases} x(k+1) = F(\alpha) \cdot x(k) + G(\alpha) \cdot E(k) \\ y(k) = C \cdot x(k) \end{cases} \quad (3)$$

To calculate $F(\alpha)$ and $G(\alpha)$ at the beginning of each period, for any $(\alpha_i)_{i=1 \dots 3}$, all possible configurations must be considered.

In the case where the duty-cycles are equals ($\alpha_1 = \alpha_2 = \alpha_3$), only three different configurations exist (figure 3). However, in the closed loop control, the duty-cycles are different in the transient and can take any value between 0 and 1. The number of the different configurations to be treated increases then considerably.

The validation of this model is shown in figure 4. The calculation of $F(\alpha)$ and $G(\alpha)$ was computed using MATLAB. The converter is simulated by SIMULINK (instantaneous model) using a linear state feedback decoupling control [3].

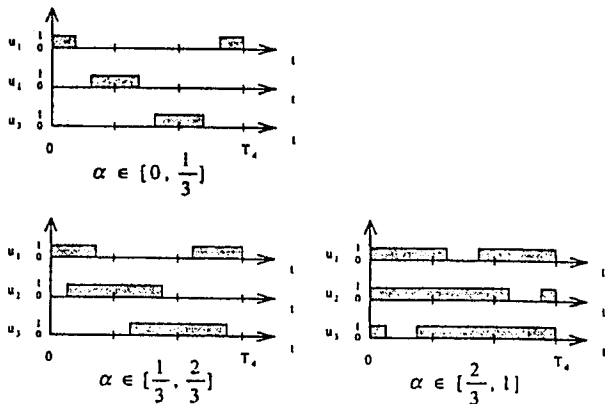

Figure 3. The different configurations of the control signals over one period when the duty-cycles are equals.

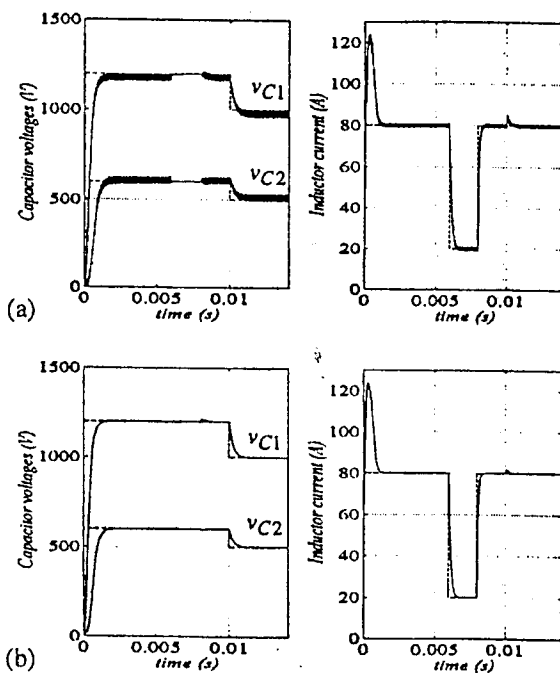

Figure 4. Validation of the discrete-time model. (a) Instantaneous model. (b) Discrete-time model.

The converter parameters are:

$f_d = 16 \text{ kHz}$, $C_1 = C_2 = 40 \mu\text{F}$, $L = 1.5 \text{ mH}$, $R = 10 \Omega$ and $E = 1800 \text{ V}$. The control test is:

- At $t=0$, start converter with of the $i_{Lref} = 80 \text{ A}$
- At $t=6\text{ms}$ step of the current reference of -60 A
- At $t=8\text{ms}$ step of the current reference of $+60 \text{ A}$
- At $t=10\text{ms}$ step of the input voltage of -300 V

3. OBSERVABILITY OF THE THREE-CELL CHOPPER

Referring to the discrete-time model of the converter (3), where the duty-cycles are known at each time instant, we see that the system is linear and time varying. Thus, we determine observability by checking that the observability Grammian [5] of the system representation is positive definite.

For any particular trajectory, this could be difficult to calculate, but for periodic steady-state operation we can easily check observability over one period.

Indeed, in the steady-state case, the duty-cycles are equals and constants. The system (3) is then stationary and the Kalman observability test can be used [6].

From figure 5, we see that the observability matrix

$$Q_{obs} = \begin{bmatrix} C \\ C \cdot F(\alpha) \\ C \cdot F^2(\alpha) \end{bmatrix}$$

is non-singular for any duty-cycle

$0 < \alpha < 1$. The system is then observable in this domain.

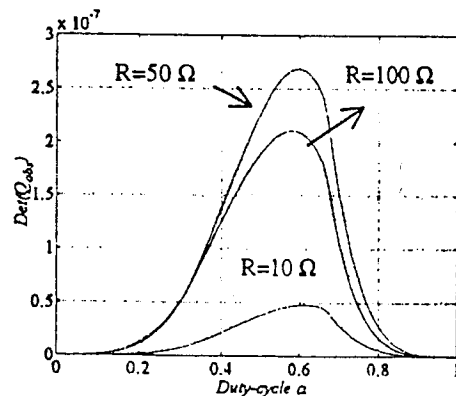

Figure 5. Determinant of the observability matrix when the duty-cycles are equals.

Note also that the determinant value of the observability matrix is very weak. This must cause a sensitivity problem like we will see in the next section.

4. OBSERVER DESIGN

When all parameter values are known, the first step in constructing a state observer for the system (3) is to construct a system that exactly copies the dynamics of this system.

Such a system would take the form:

$$\hat{x}(k+1) = F(\alpha) \cdot \hat{x}(k) + G(\alpha) \cdot E(k) \quad (4)$$

where the vector \hat{x} is an estimate of the state vector x .

It is essential that the observer state \hat{x} converge to the system state x . In order to study this behavior, one needs

to examine the error dynamics that govern the error $e = x - \hat{x}$, i.e. $e(k+1) = F(\alpha) \cdot e(k)$.

In order to improve the observation error dynamics, observer theory leads one to incorporate a prediction error term formed from the difference between the measurement y of the output in (3) and the predicted output $\hat{y} = C \cdot \hat{x}$. The observer is then completed by injecting a signal proportional to the prediction error into the right-hand side of (4) yielding the observer system

$$\hat{x}(k+1) = F(\alpha) \cdot \hat{x}(k) + G(\alpha) \cdot E(k) + L(k) \cdot [y - C \cdot \hat{x}(k)] \quad (5)$$

with the associated error dynamics:

$$e(k+1) = [F(\alpha) - L(k) \cdot C] \cdot e(k) \quad (6)$$

In the linear case (α constant), the Luenberger observer [6][7] can be used and the gain L is constant. Since the system output $y(k)$ is a scalar, the calculation of the observer gain L can be solved by the Ackermann's formula [6]:

$$L = \left[\prod_{i=1}^3 (F(\alpha) - z_i I_3) \right] \cdot \begin{bmatrix} C \\ C \cdot F(\alpha) \\ C \cdot F^2(\alpha) \end{bmatrix}^{-1} \begin{bmatrix} 0 \\ 0 \\ 1 \end{bmatrix} \quad (7)$$

where $(z_i)_{i=1..3}$ are the desired discrete-pole locations of the observer and I_3 denote the 3×3 identity matrix.

In figure 6, actual and observed states are shown in the open loop and steady-state case with $\alpha_1 = \alpha_2 = \alpha_3 = 0.4$ and $z_1 = z_2 = z_3 = 0.716$.

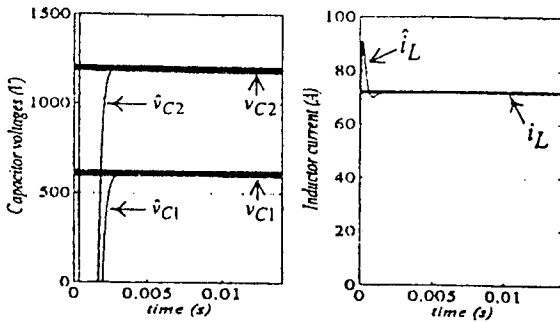

Figure 6. Actual and observed states in the steady-state case.

The converter parameters are the same as those given in section 2. The initial conditions of the observer are: $\hat{v}_{C1}(0) = 100 \text{ V}$, $\hat{v}_{C2}(0) = 1000 \text{ V}$, $\hat{i}_L(0) = 0 \text{ A}$.

Note that in steady-state operation, the capacitor voltages v_{C1} and v_{C2} are balanced to $E/3$ and $2E/3$ respectively. The switching voltage in each cell is then reduced to $E/3$.

In the controlled system, the duty-cycles are time varying in the transient. The matrix $F(\alpha)$ and $G(\alpha)$ are thus time varying and will be noted $F(k)$ and $G(k)$ in the rest of the manuscript. The gain vector L must also be time varying in order to guarantee the stability of the system.

Denoting $F_b(k) = F(k) - L(k) \cdot C$, the observer equation (5) can be rewritten in the form:

$$\hat{x}(k+1) = F_b(k) \cdot \hat{x}(k) + G(k) \cdot E(k) + L(k) \cdot y(k) \quad (8)$$

To calculate the gain vector $L(k)$, we use the following method:

At the beginning ($k=0$) the gain vector is calculated using the Ackermann's formula to impose the dynamics of $F_b(0)$:

$$L(0) = \left[\prod_{i=1}^3 (F(0) - z_i I_3) \right] \cdot \begin{bmatrix} C \\ C \cdot F(0) \\ C \cdot F^2(0) \end{bmatrix}^{-1} \begin{bmatrix} 0 \\ 0 \\ 1 \end{bmatrix}$$

At time k , the gain is calculated in order to stabilize the system represented by the equation between $\hat{x}(0)$ and $\hat{x}(k+1)$. In other words, the calculation of $L(k)$ is done in order to impose the dynamics of $F(k) = F_b(k) \cdot F(k-1)$

$$\text{where } F(k) = \prod_{l=0}^k F_b(l)$$

Since $F_b(k) = F(k) - L(k) \cdot C$ and denoting $\bar{F}(k) = F(k) \cdot F(k-1)$ and $\bar{C}(k) = C \cdot F(k-1)$, the matrix $F(k)$ can be rewritten as:

$$F(k) = \bar{F}(k) - L(k) \cdot \bar{C}(k) \quad (9)$$

According to the Ackermann's formula the gain vector is then:

$$L(k) = \left[\prod_{i=1}^3 (\bar{F}(k) - z_i^{k+1} I_3) \right] \cdot \begin{bmatrix} \bar{C}(k) \\ \bar{C}(k) \cdot \bar{F}(k) \\ \bar{C}(k) \cdot \bar{F}^2(k) \end{bmatrix}^{-1} \begin{bmatrix} 0 \\ 0 \\ 1 \end{bmatrix} \quad (10)$$

Such observer was applied to a three-cell chopper using a linear state feedback decoupling control [3].

Recall that with this control strategy, the system is completely decoupled and behave like three first-order subsystems (figure 7). In the current control loop, we have added a PI regulator in order to avoid the static errors in steady state and reduce the current overshoot in transient [3]. The time-constants are chosen: $\tau_1 = \tau_2 = 300 \mu\text{s}$ and $\tau_3 = 90 \mu\text{s}$.

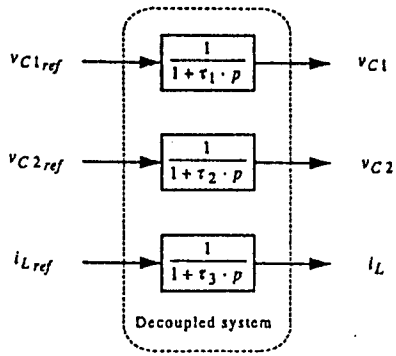

Figure 7. The equivalent system of the three-cell chopper after state decoupling.

The dynamics chosen for the observer must be higher than the closed-loop dynamics in order to assure a fast convergence. We choose: $z_1 = z_2 = z_3 = 0.41$.

The closed loop output using the estimated states, are shown in figure (8).

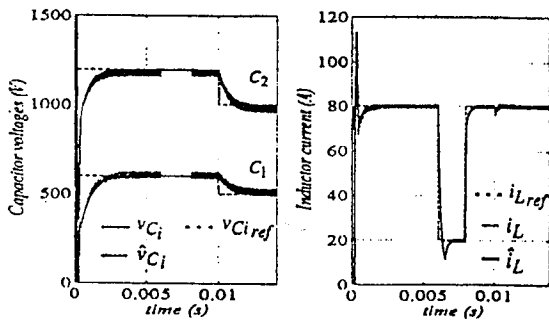

Figure 8. Actual and observed states in the three-cell chopper with a closed-loop control.

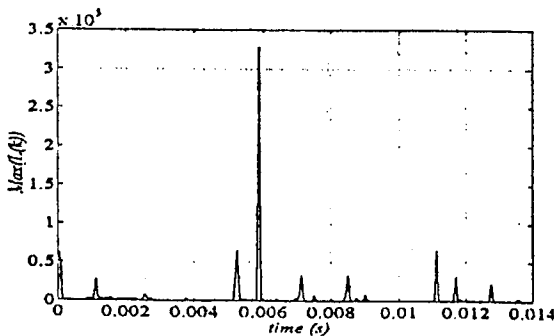

Figure 9. The maximum of the gain vector $L(k)$.

The initial conditions of both observer and the system are:

$$\hat{v}_{C1}(0) = 100 \text{ V}, \hat{v}_{C2}(0) = 1000 \text{ V}, \hat{i}_L(0) = 0 \text{ A},$$

$$v_{C1}(0) = 300 \text{ V}, v_{C2}(0) = 600 \text{ V}, i_L(0) = 10 \text{ A}.$$

The converter parameters and the simulation tests are the same as in section 2.

From figure 9, we see that the gain components are important. This is due to the weak value of $\det(Q_{obs})$ (see figure 5)

To improve the robustness of this observer via the noise measurements, we propose the following observer (figure 10).

when $|y(k) - \hat{y}(k)| > \epsilon$ we use the gain given by (10).
when $|y(k) - \hat{y}(k)| \leq \epsilon$ we use a null gain (predictor).

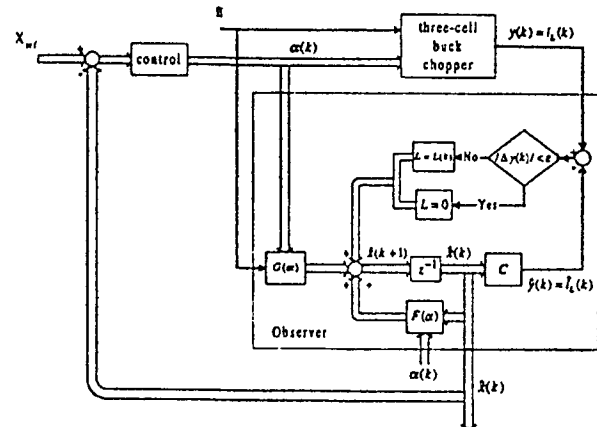

Figure 10. structure of the observer

The results of the new simulations using this observation algorithm are shown in figure 11.

In the measured current, we have added a Gaussian noise with a standard deviation of $\sigma=0.1$ A. The converter parameters are the same as in the last simulation and we took $\epsilon=0.5$ A.

We see that the gain components are important when the prediction error $\Delta y = i_L - \hat{i}_L$ is important and null when $\Delta y \leq 0.5$.

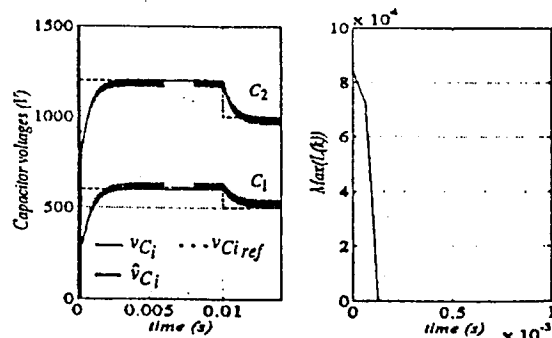

Figure 11. Simulation results using the observer of figure 10.

Note that the choice of a null gain in steady state is done in order to guarantee the stability of the observer. We can of course choose a gain $L \neq 0$ but we must find this gain so that the observer remains stable for all operating points.

5. CONCLUSION

In this paper we have developed an observer for a three-cell chopper based on a discrete-time model and using a linear approach.

We saw, thus, that it is possible to observe the capacitor voltages, measuring the load current one time in a period. However, due to the small value of the observability matrix determinant, the gain components are very important and the robustness is deteriorated.

In order to improve the robustness in steady-state operation, we annul the gain vector L when the prediction error $\Delta y = \hat{i}_L - i_L$ is small. Thus in transient, the observer converge quickly and the robustness is improved in steady state.

This observer strategy constitutes an intermediate between the Luenberger observer and the Kalman filter.

Note, finally, that in our procedure, the knowledge of the converter parameters is necessary.

6. REFERENCES

- [1] T. Meynard, H. Foch: "Multilevel conversion: high voltage choppers and voltage-source inverters", *Power Electronics Specialists Conference*, Toledo, 1992, pp 397-405.
- [2] G. Gateau: "Contribution à la commande des convertisseurs statiques multicellulaires série", *Thèse de doctorat de l'INP Toulouse*, 1997.
- [3] O. Tachon, M. Fadel, T. Meynard: "Control of series multicell converters by linear state feedback decoupling", *European Conference on Power Electronics and Applications (EPE'97)*, 1997, pp. 1.588-1.593.
- [4] D. Pinon, M. Fadel, T. Meynard: "Commande par mode glissant d'un hacheur à deux cellules: étude de l'installation des cycles limites", *Revue Internationale de Génie Electrique*, Vol. 1, No 3, 1998, pp 393-415.
- [5] A.J. Fossard, D. Normant-Cyrot: "Systèmes non linéaires", *Masson*, 1993.
- [6] C.L. Phillips, H.T. Nagle: "Digital control system. Analysis and design", *Prentice Hall*, 1995.
- [7] D.G. Luenberger: "Observing the state of a linear system", *IEEE Trans. Mil. Electron*, Vol. MIL 8, April 1966, pp. 1703-1713.
- [8] H. Buhler: "Réglages échantillonnés", *presses Polytechniques Romandes*, Vol. 2, 1983.