



# MEA 2021 MORE ELECTRIC AIRCRAFT

Bordeaux, France  
October, 20-21, 2021



## a typical MDO process for future Hybrid Electric aircrafts



*Laplace*

Xavier  
Roboam

on behalf of

F. Accorinti (Phd Student), V. Ayel,  
Y. Bertin, M. Fenot, E. Videcoq, A.  
Zeaiter (Phd Student)



P. Simon



This project has received funding from the [European Union's Horizon 2020 (cleansky 2 JTI) research and innovation programme, 2014-2024] under grant agreement No 715483

M. Banda (Post Doc Student), J. P. Cambronne, P. Collin (Phd Student), S. Dutour, N. Erroui (Phd Student), G. Gateau, Y. Lefevre, J.F. Llibre, D. Malec, M. Miscovic, M. Pettes-Duler (Phd Student), X. Roboam, N. Roux, B. Sareni, M. Tognan (Post Doc Student), S. Touhami (Phd Student), C. Turpin

- ✓ Engine benefits: design and operation may be revisited with power hybridization



Gas turbine

- ✓ Energy benefits: turboshaft efficiency

$\eta_{GT} \sim 10\%$  for thermal descent or taxi

$\eta_{GT} \sim 90\%$  for electric descent or taxi

- ✓ Aerodynamic benefits: several concepts

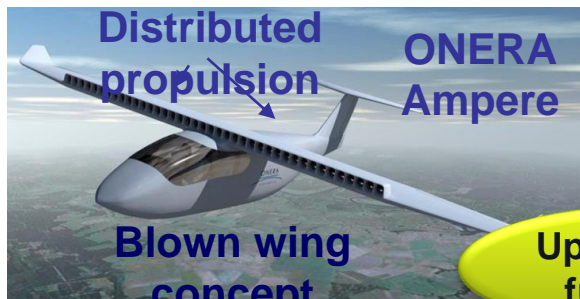

Up to  $-2.5\%^*$  fuel burn

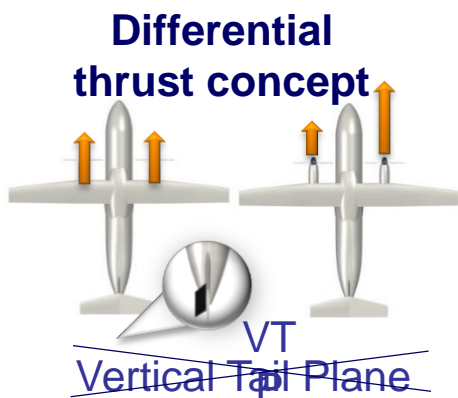

$\sim -4.5\%^*$  Fuel burn



$< -13\%^* ??$  Fuel burn

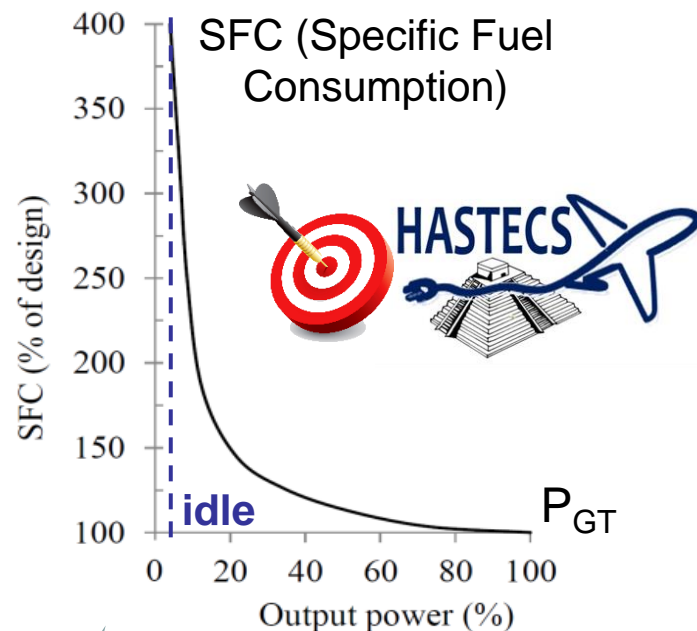



**H**ybrid **A**ircraft  
**A**cademic re**S**earch on **T**hermal  
 & **E**lectrical **C**omponents and **S**ystems



**AIRBUS**

## Series Hybrid electric Architecture

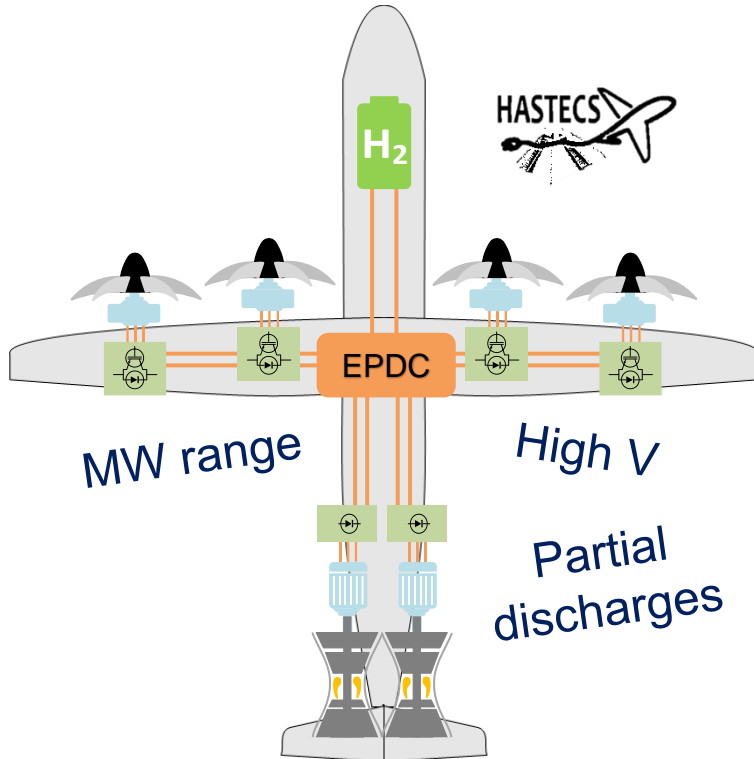

(regional, 70 pax)

LEGEND	
PROPELLER + GEARBOX	
E-MOTOR + COOLING	
CABLE	
DC/AC CONVERTER + COOLING	
ELECTRICAL POWER DISTRIBUTION CENTER	
BATTERY/FUEL CELL	
AC/DC CONVERTER	
E-GENERATOR	
TURBOSHAFT	



# Multidisciplinary Design Optimization (MDO) of the hybrid-electric aircraft powertrain

A set of coupled sizing variables :

- Geometry (propeller, emotor)
- Mechanical (gearbox)
- Electromagnetic (emotor)
- Electrical (bus voltage)
- Source sizing (fuel cell, turboshaft)
- Energy management

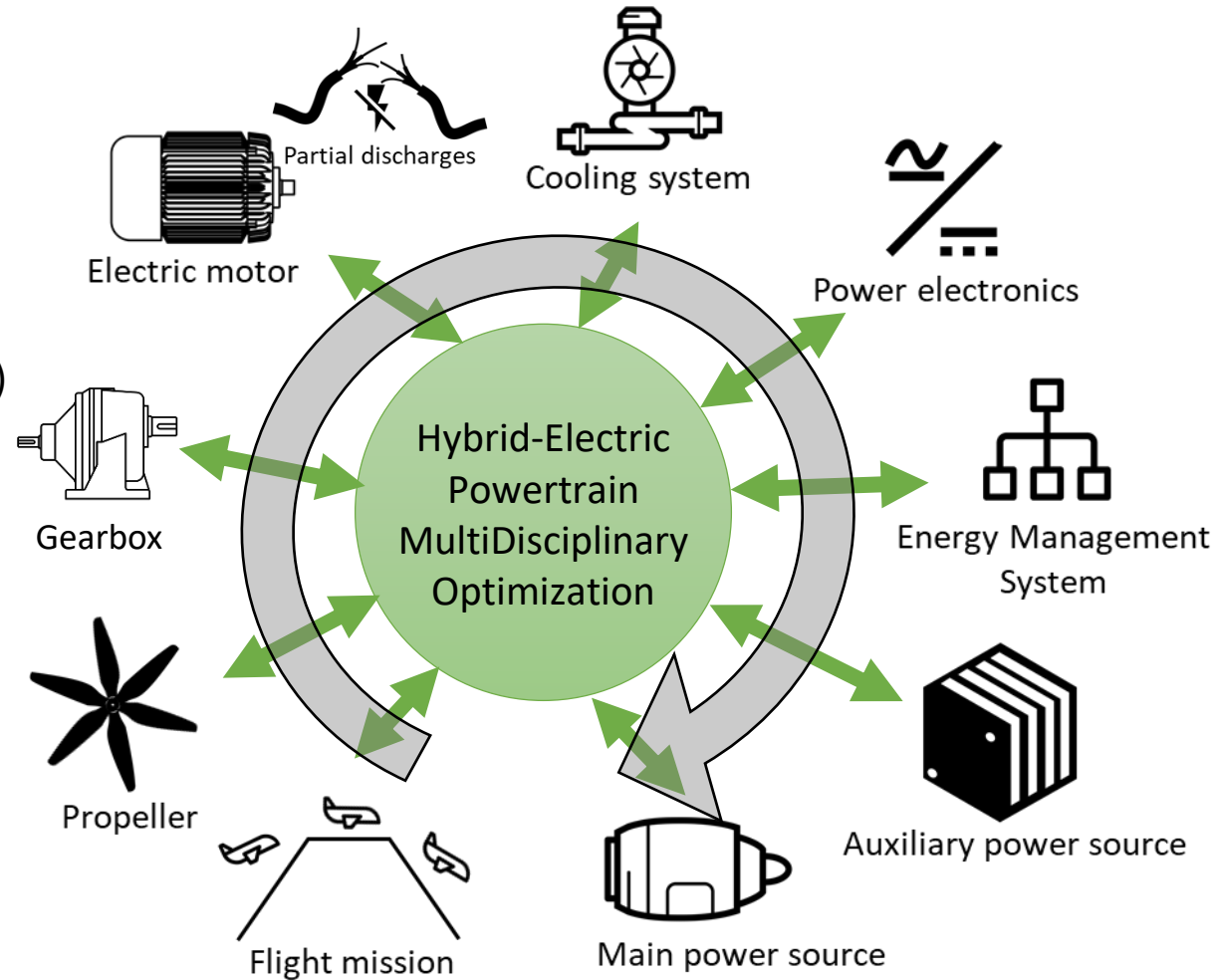

# Multidisciplinary Design Optimization (MDO) of the hybrid-electric aircraft powertrain

## ➤ Design of highly integrated power electronics with its cooling

A set of coupled sizing variables :

- Geometry (propeller, emotor)
- Mechanical (gearbox)
- Electromagnetic (emotor)
- Electrical (bus voltage)
- Source sizing (fuel cell, turboshaft)
- Energy management

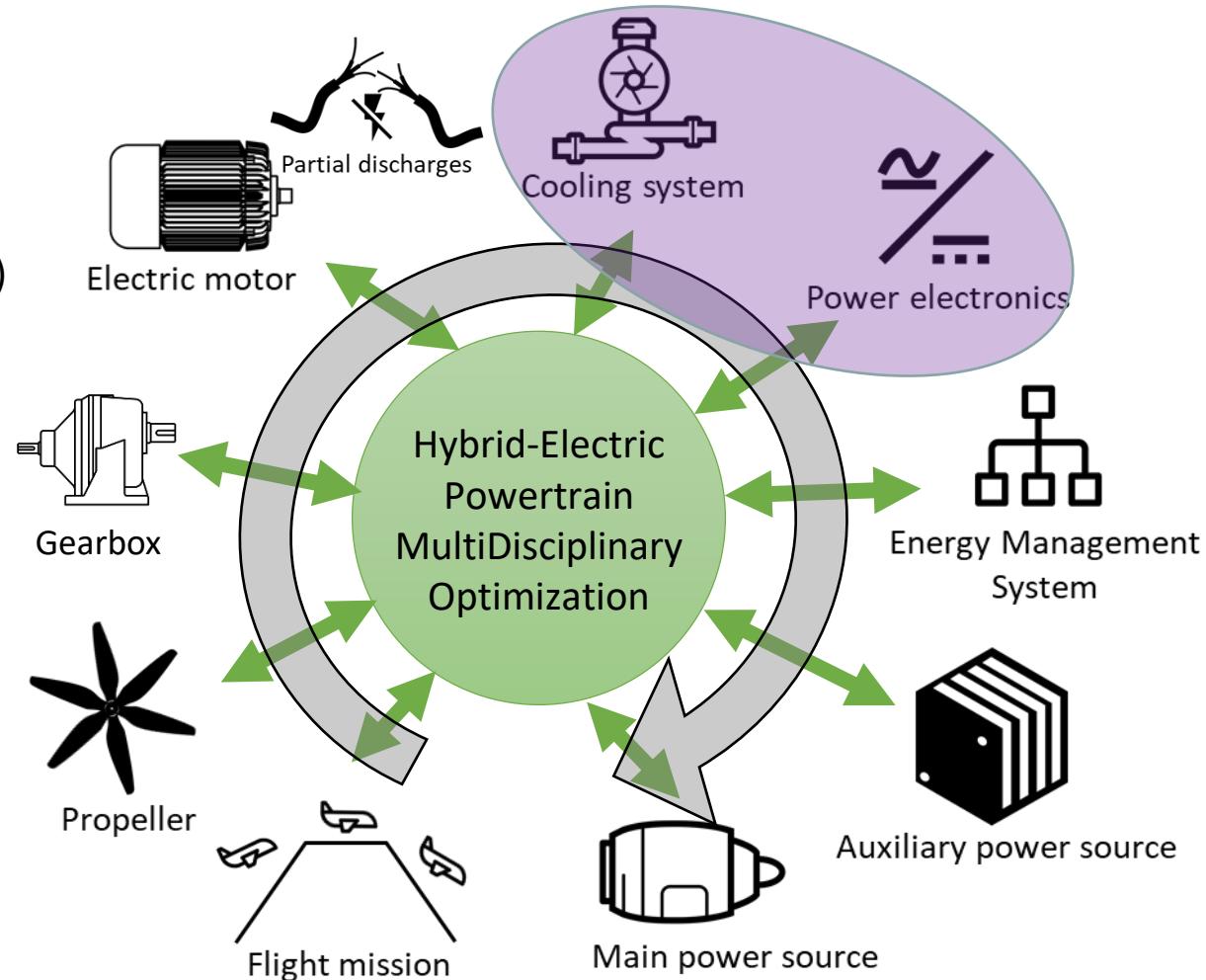

# Multidisciplinary Design Optimization (MDO) of the hybrid-electric aircraft powertrain

## ➤ Design of highly integrated power electronics with its cooling

Specific power increase  
(kW/kg)



Heat exchanger optimization (WP4)

Power Electronics losses reduction

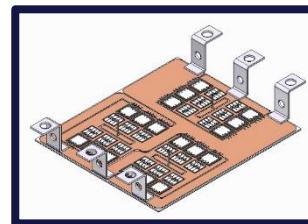

Bus bar optimization



Improved components

Small rating components

Control strategies

New generation IGBT

SiC components

Direct series association

Multilevel architecture

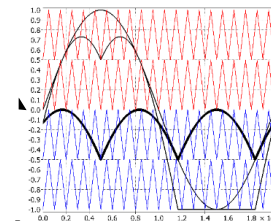

DPWMMIN  
5-level

ANPC-5L  
Beyond 2kV bus

Cell2 (DC-2L)  
Fsw = 50Hz

Properties :	
V ripple	= E/4
F ripple	= 4 * F <sub>switch</sub>
V <sub>max</sub> IGBT	= E/4

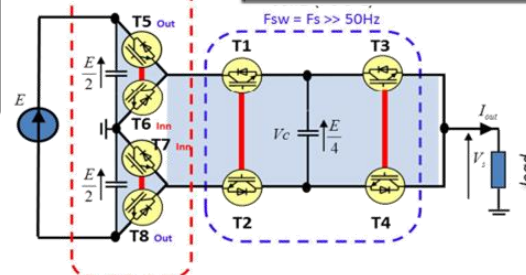

➤ MW range ;  $\eta \sim 99\%$

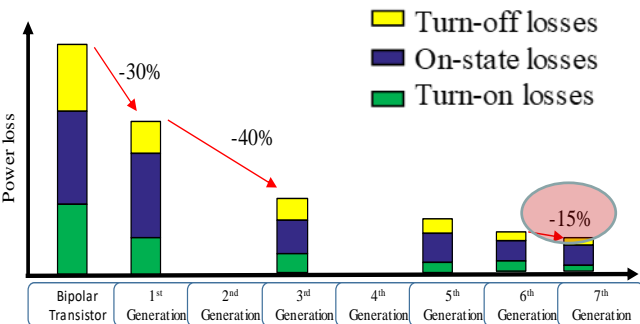

1200-1700V Si 7th generation @ low conduction losses

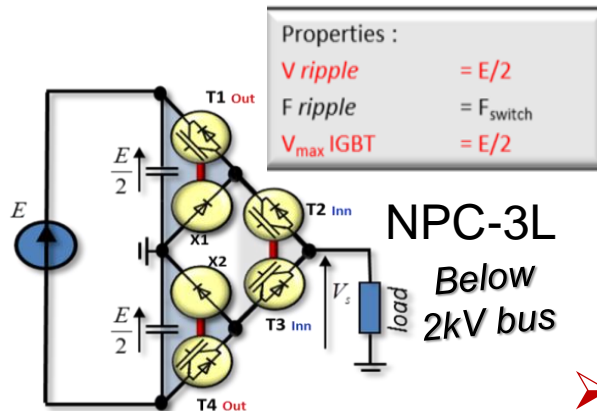

Properties :	
V ripple	= E/2
F ripple	= F <sub>switch</sub>
V <sub>max</sub> IGBT	= E/2

NPC-3L  
Below 2kV bus

# Multidisciplinary Design Optimization (MDO) of the hybrid-electric aircraft powertrain

## ➤ Design of highly integrated power electronics with its cooling

Evaporator HTC ( $W/m^2 \cdot ^\circ K$ )

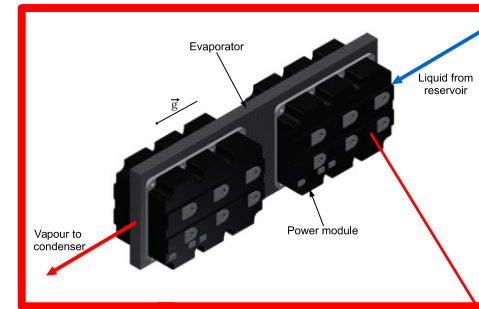
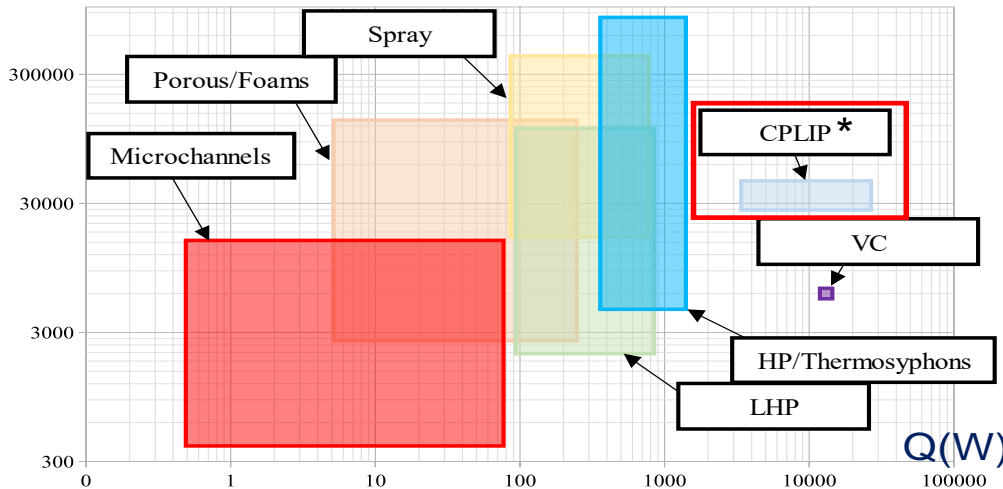

- Stability
- Reliability
- low mass
- Controlled temp

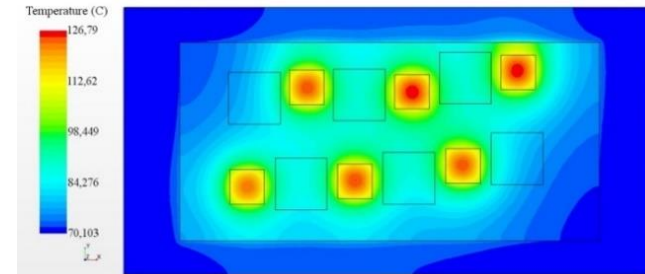
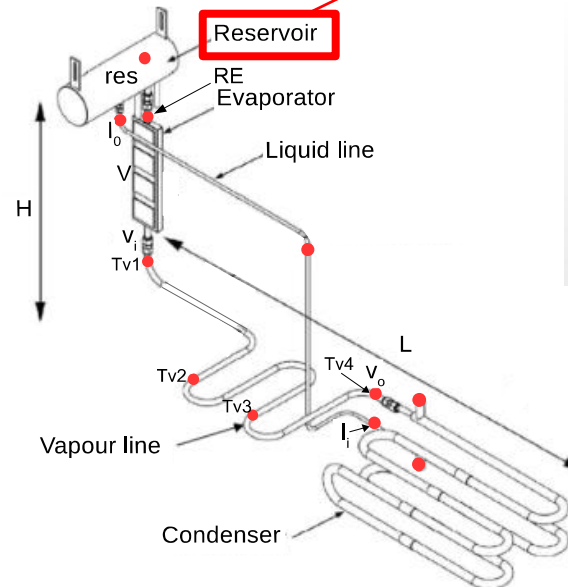

**Junction temperature  $< 150^\circ C$ !**  
**4.5 kW (of losses) /kg !**



\* CPLIP: Capillary Pumped Loop for Integrated power

# Multidisciplinary Design Optimization (MDO) of the hybrid-electric aircraft powertrain

## ➤ Design of highly integrated power electronics with its cooling

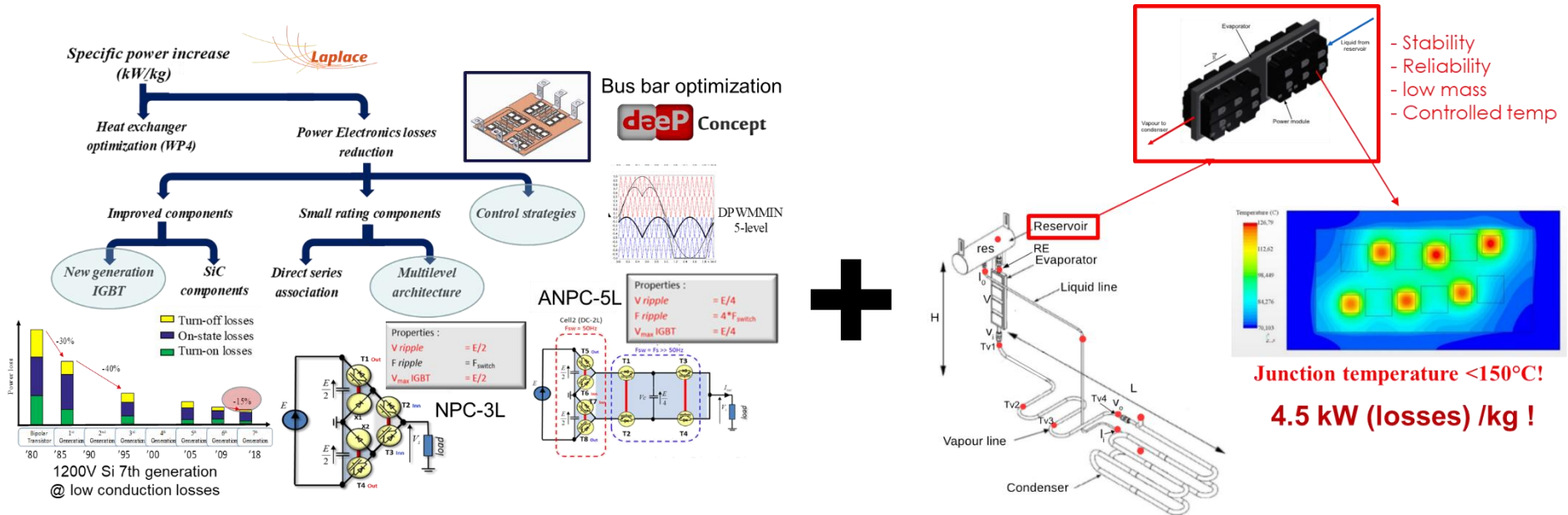

➤ MW range ;  $\eta \sim 99\%$  ;  $> 30\text{kW/kg}$



# Multidisciplinary Design Optimization (MDO) of the hybrid-electric aircraft powertrain

A set of coupled sizing variables :

- Geometry (propeller, **emotor**)
- Mechanical (gearbox)
- Electromagnetic (**emotor**)
- Electrical (bus voltage)
- Source sizing (fuel cell, turboshaft)
- Energy management

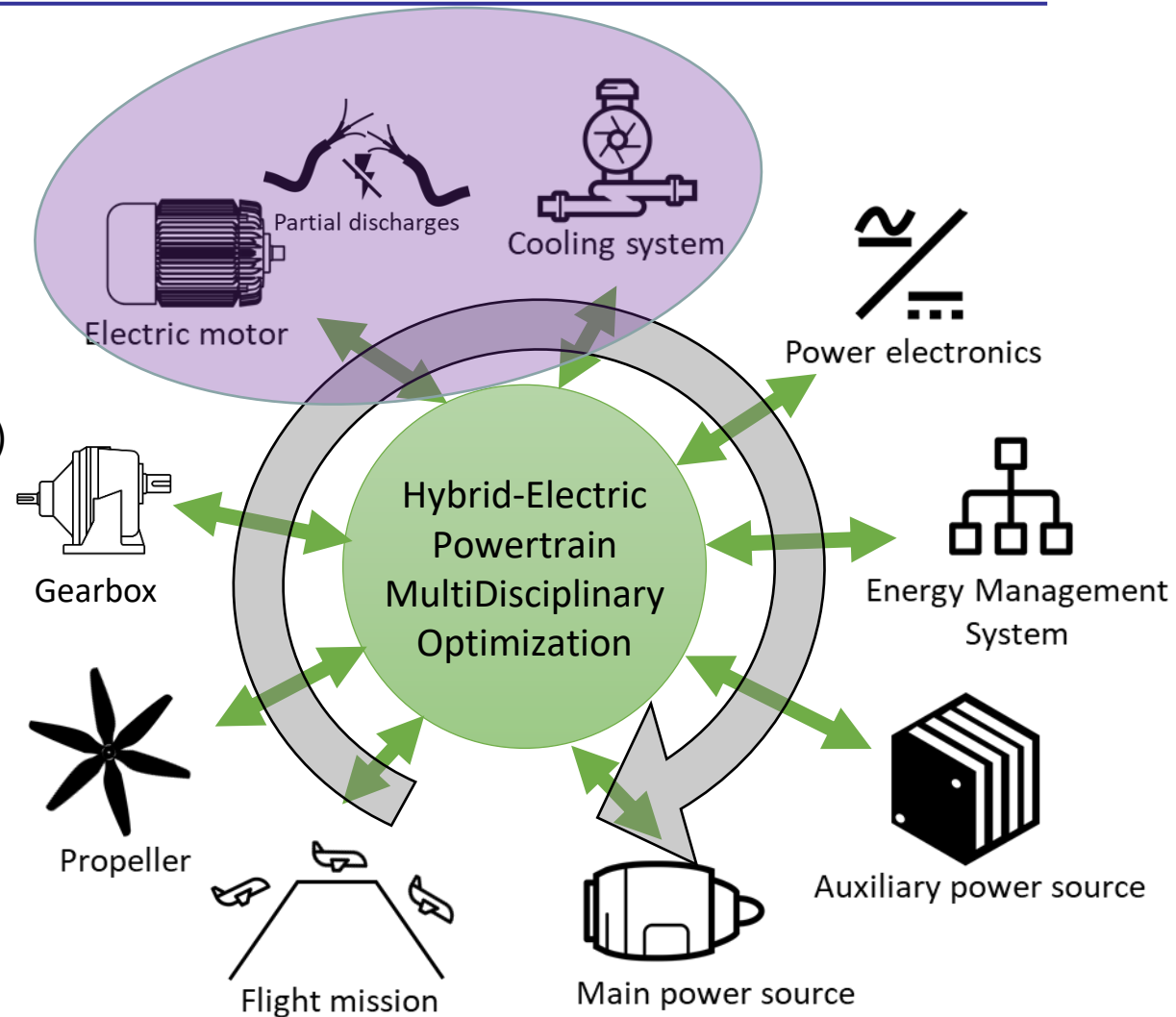

# Multidisciplinary Design Optimization (MDO) of the hybrid-electric aircraft powertrain

## ➤ Design of highly integrated eMotor with its cooling

Several drivers to increase both specific power and efficiency

To decrease electric machine (PMSM) mass

- Increase peripheral speed up to 200m/s with sleeve having Strength tensile > 1600MPa

- Increase current densities:  $J_{rms} > 25A/mm^2$  et  $K_{rms} > 100$  kA/m for internal cooling inside slots

- Increase flux density in air gap: high temperature permanent magnets (SmCo or NdFeB):  $B_r(\text{SmCo}) = 1.16T$  for  $B_m=0.9T$

- Increase number of pole pairs: Halbach,  $N_p > 10$

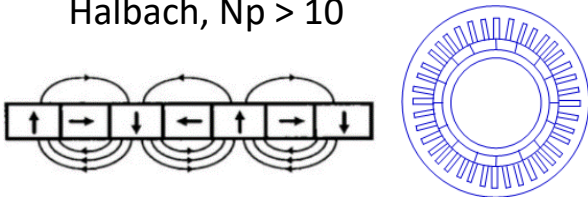

And other drivers...

To decrease cooling system mass

Decrease losses  $\rightarrow \uparrow \eta$

- decrease Joule losses (DC and AC):

Twisted Litz wires

High filling coefficient

$$R_{AC}/R_{DC} \sim 1 \text{ for } 400\text{Hz @ } 5\text{kHz}$$



- Decrease iron losses:

- Use thin magnetic sheets (very thin sheets 100-200 $\mu\text{m}$  and future 50 $\mu\text{m}$ )

Design of winding with partial discharge tolerant insulation

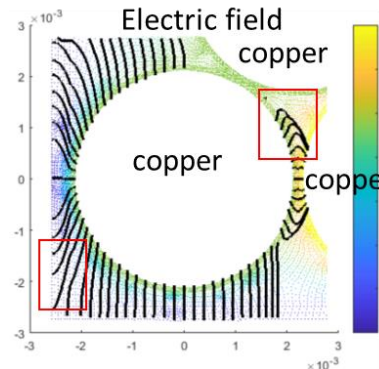
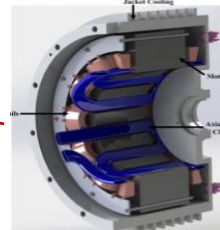
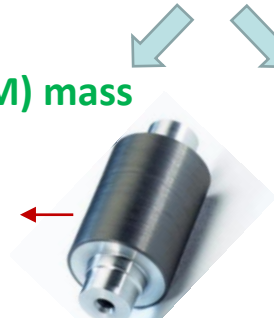
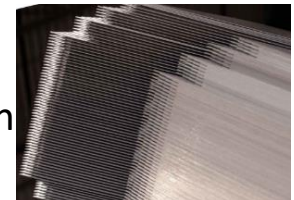

# Multidisciplinary Design Optimization (MDO) of the hybrid-electric aircraft powertrain

## ➤ Design of highly integrated eMotor with its cooling

External cooling for stator & internal for rotor

### Cooling system:

- ✓ Heat exchanger = nacelle
- ✓ Liquid cooling

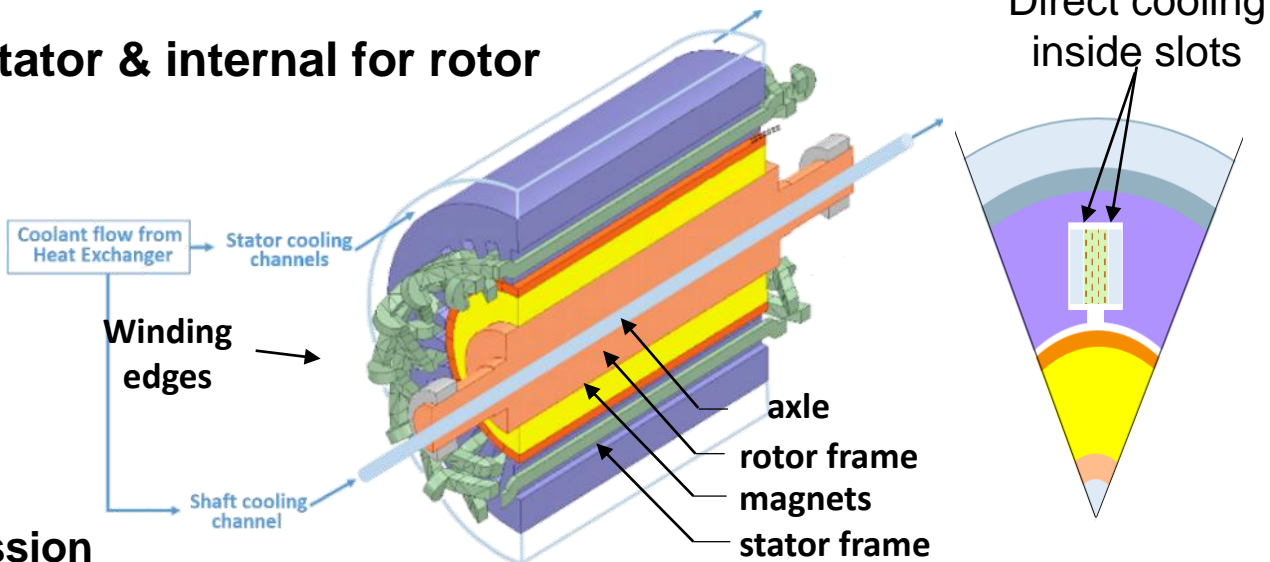

## ➤ Importance of thermal transient during flight mission

STATOR TEMPERATURE PROFILE (°C)

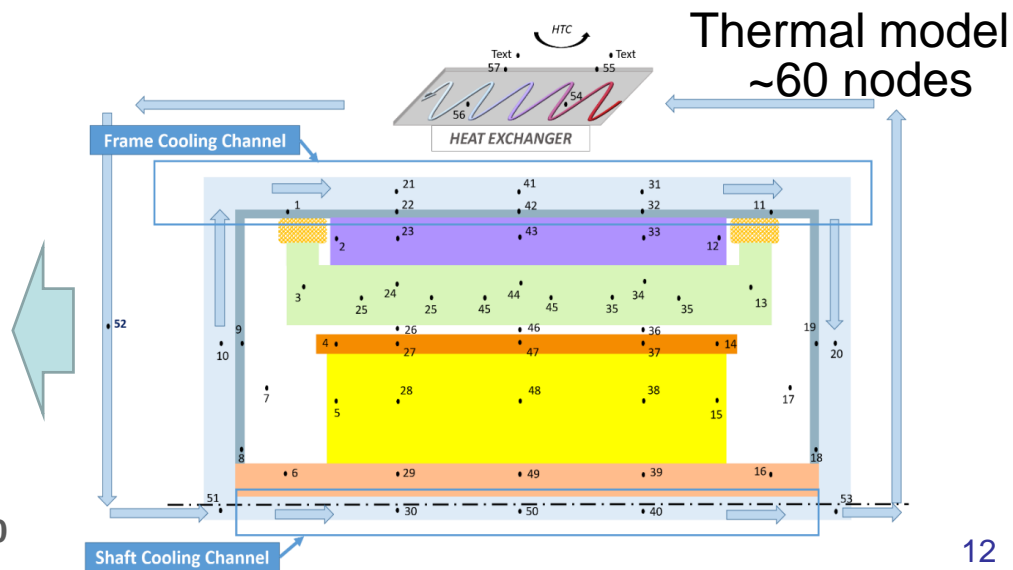
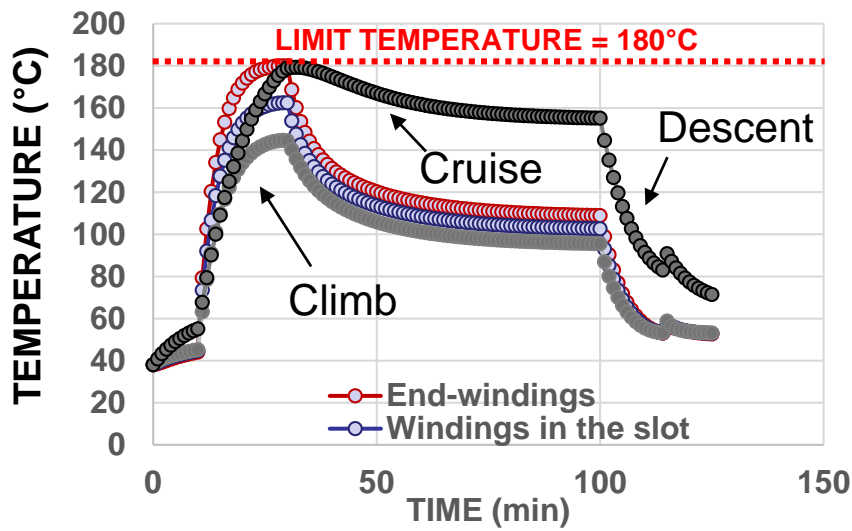

# Multidisciplinary Design Optimization (MDO) of the hybrid-electric aircraft powertrain

## ➤ Design of highly integrated eMotor with its cooling

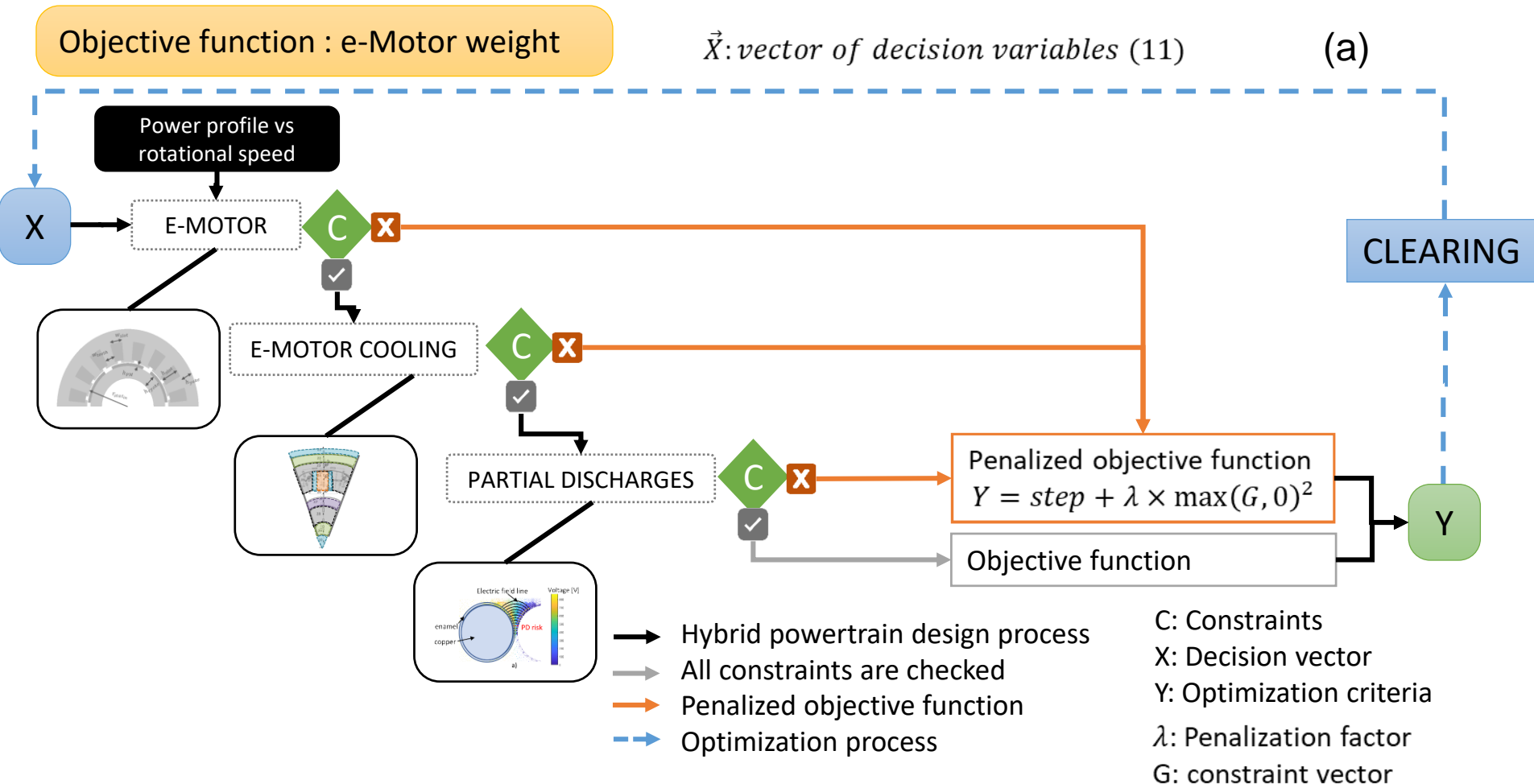

# Multidisciplinary Design Optimization (MDO) of the hybrid-electric aircraft powertrain

## ➤ Design of highly integrated eMotor with its cooling

Objective function : e-Motor weight

$\vec{X}$ : vector of decision variables (11)

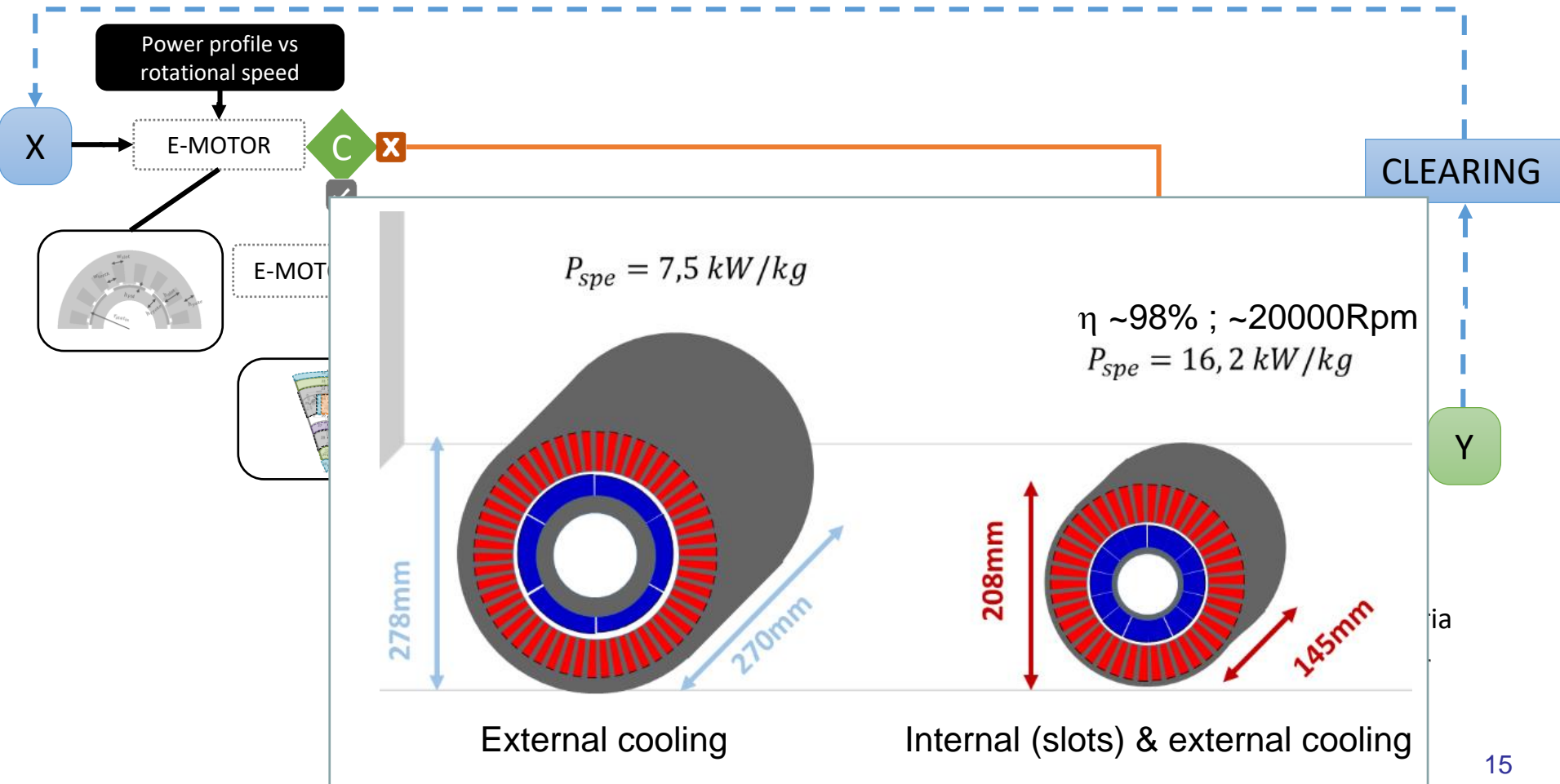

# Multidisciplinary Design Optimization (MDO) of the hybrid-electric aircraft powertrain

## ➤ MDO of the whole powertrain integrating snowball effects at aircraft level

Multidisciplinary model based on analytical or surrogate models (regression models) for facing complexity issue.

A set of sizing variables :

- Geometry (propeller, emotor)
- Mechanical (gearbox)
- Electromagnetic (emotor)
- Electrical (bus voltage)
- Source sizing (fuel cell, turboshaft)
- Energy management

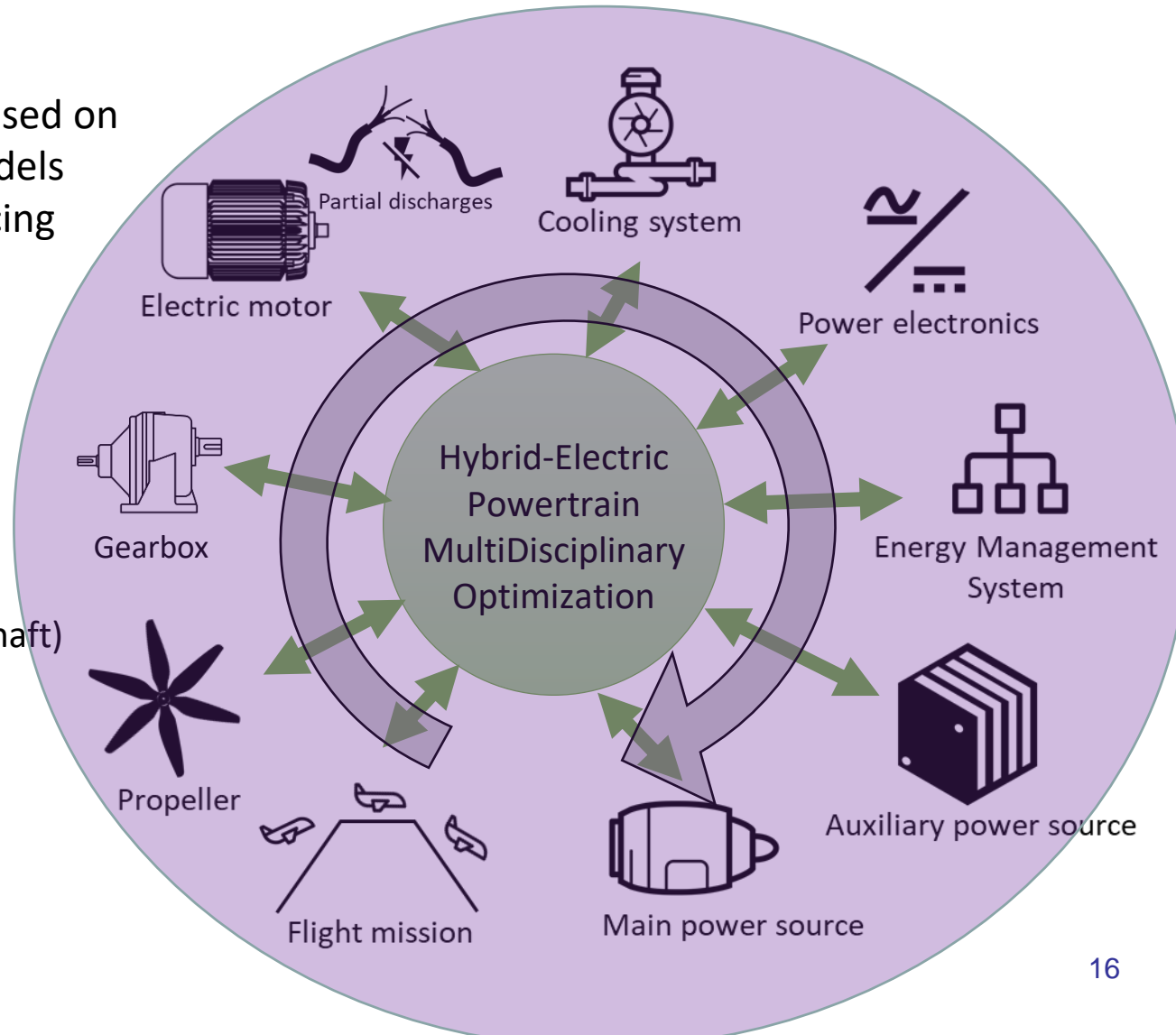

## ➤ Gearbox, Gas turbine, Cables, Propeller

$$\text{Parametric Value} = (\text{hp}/\text{RPM}_{\text{out}})^{0.75} \cdot (\text{RPM}_{\text{in}}/\text{RPM}_{\text{out}})^{0.15}$$

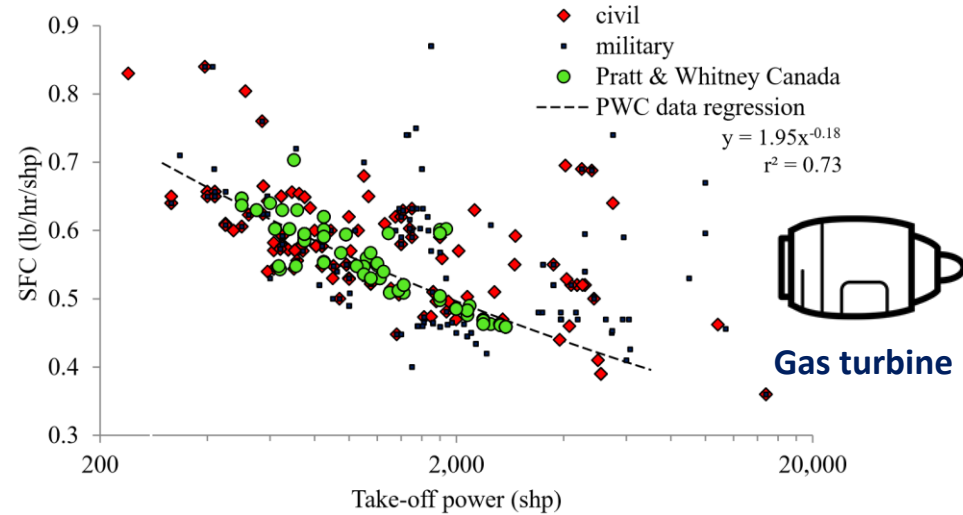
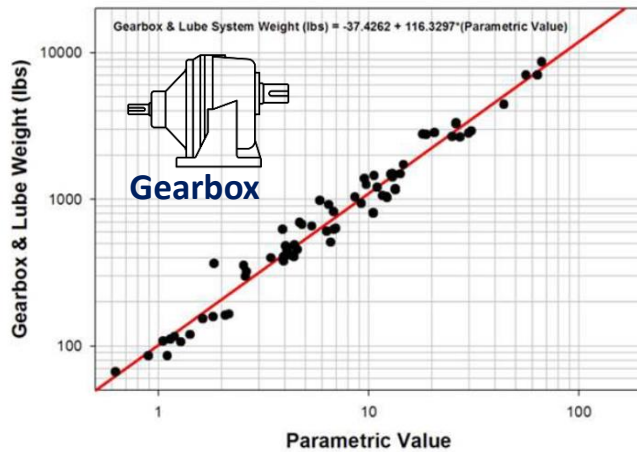

### INPUT VARIABLES

Cable electric power  
Power Factor  
Number of phases  
AC/DC voltage (depending on the cable)

### OUTPUT VARIABLES

Cable efficiency  
Cable warming  
Voltage drop  
Cable mass

### Cabling Data (Cu or Al)

GAUGE	1	0	00	----
$K_c$ [-]	11e-4	8,4e-4	6,0e-4	----
$M_{lin}$ [g/m]	470	600	750	----
$R_{lin}$ [ $\Omega$ /m]	0,5e-3	0,4e-3	0,31e-3	----
$T_{cable_{max}}$ [ $^{\circ}$ C]	220	220	220	----

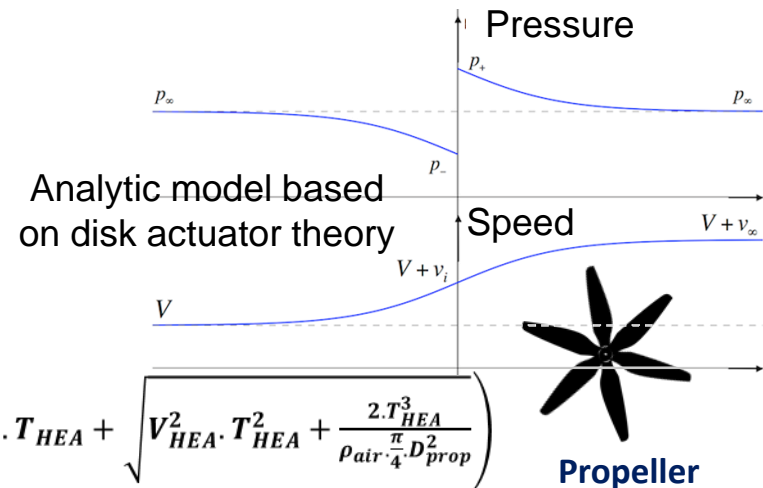

$$P_{shaft} = \frac{1}{2 \cdot k_{effd}} \cdot \left( V_{HEA} \cdot T_{HEA} + \sqrt{V_{HEA}^2 \cdot T_{HEA}^2 + \frac{2 \cdot T_{HEA}^3}{\rho_{air} \cdot \frac{\pi}{4} \cdot D_{prop}^2}} \right)$$

Propeller

## ➤ Road map on aux electrical sources: Batteries or Fuel Cells (FC) ?

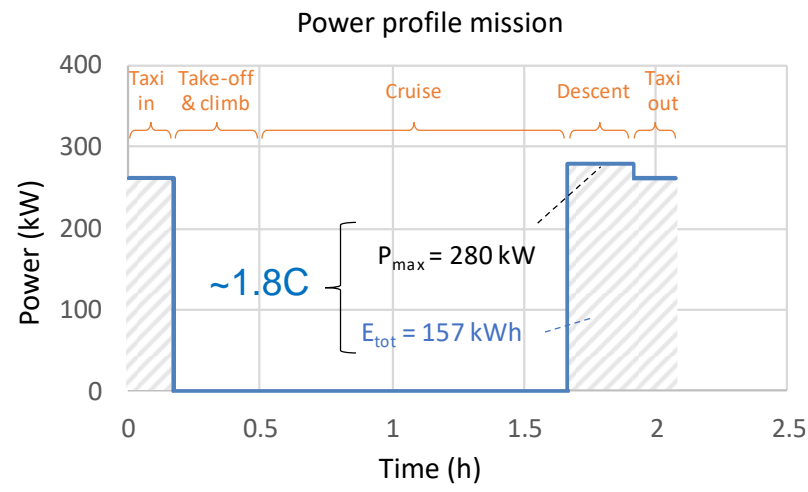
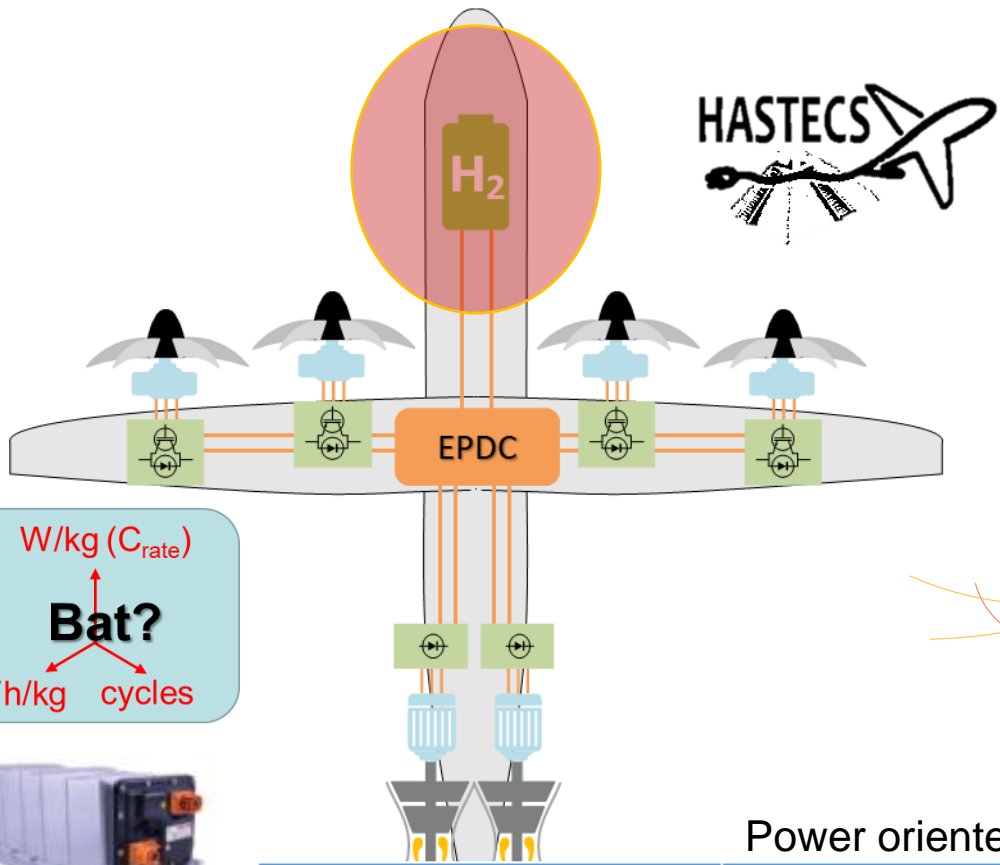

**A promising device !**

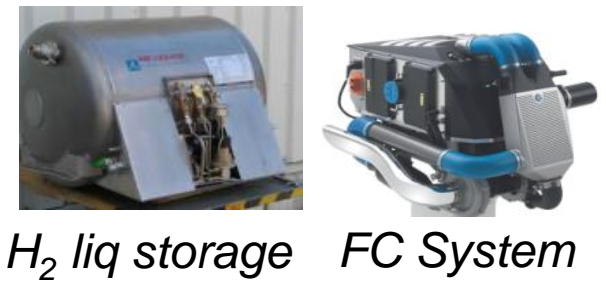

W/kg ( $C_{rate}$ )

**Bat?**

Wh/kg    cycles



**Batteries**

*Laplace*

		Power oriented	Energy oriented	
Specific energy $e_m$		LTO / TNO <sup>1,4</sup>	NMC Solid State <sup>3</sup>	FC System (LH <sub>2</sub> )
Perspectives (5 – 10 years)	Cell level	~ 180 – 200 Wh/kg	~ 650 Wh/kg	~ 1 kW/kg
	System level	~ 100 Wh/kg	~ 325 Wh/kg	~ 560 Wh/kg

x 1.8



- **Snowball effect: higher device weights cause higher thrust needs with environment couplings => linearization thrust vs MTOW**

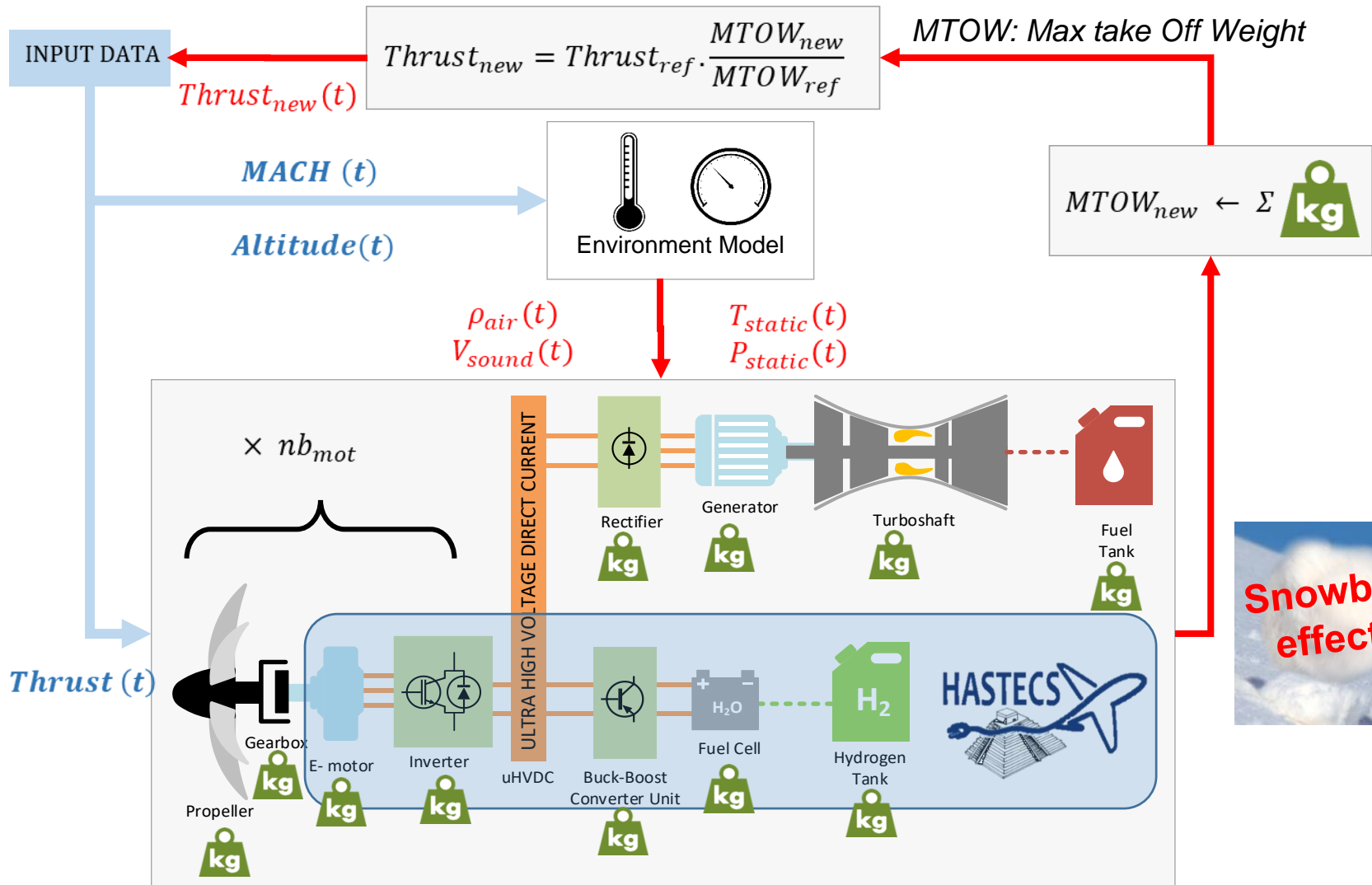

- **Snowball effect: higher device masses cause higher thrust needs with environment couplings**

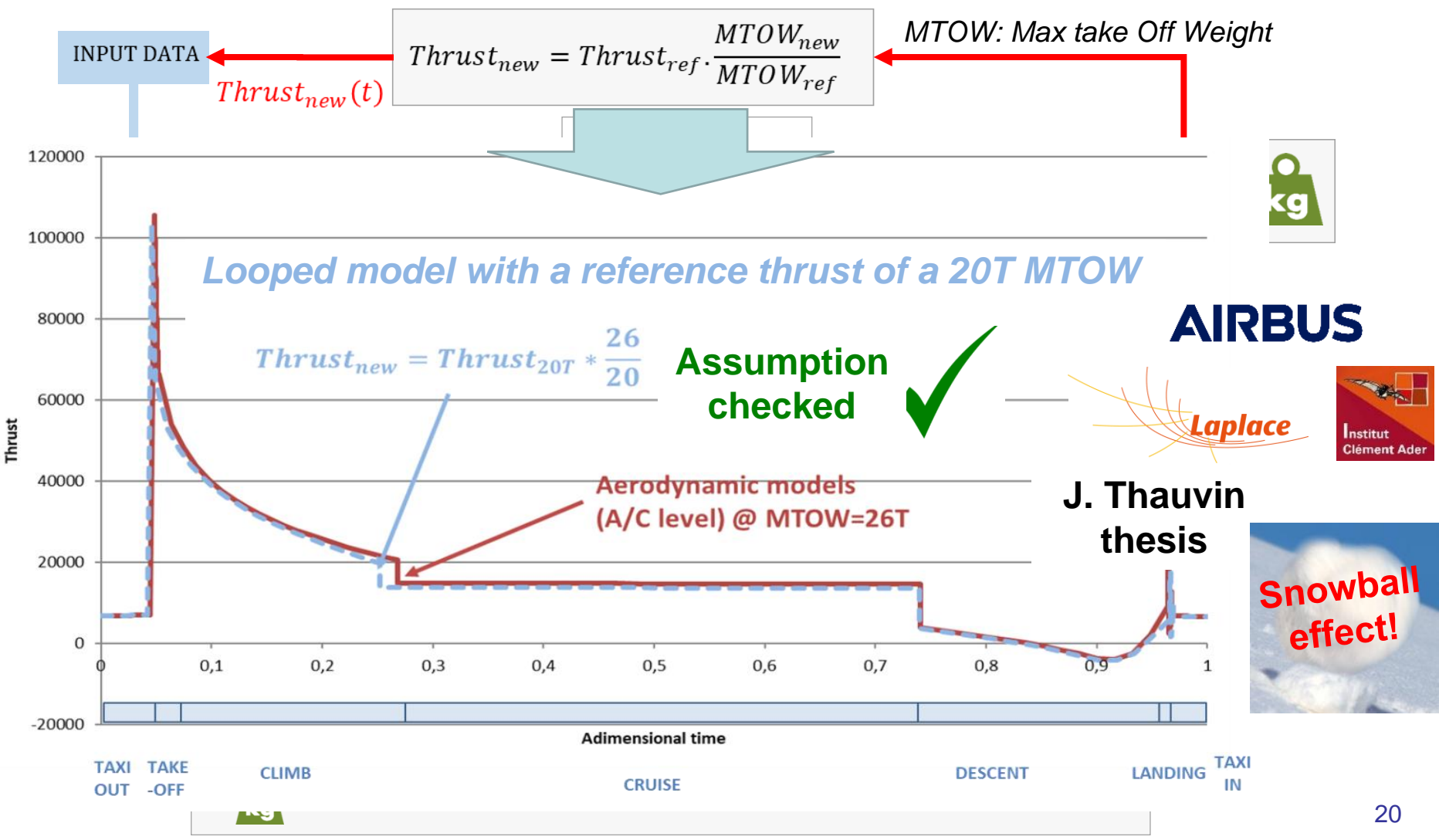

- **Snowball effect: higher device masses cause higher thrust needs with environment couplings**

### 3 optimisation formulation:

- 1 e-Motor mass *local*
- 2 Powertrain mass *global*
- 3 Fuel Burn *global*

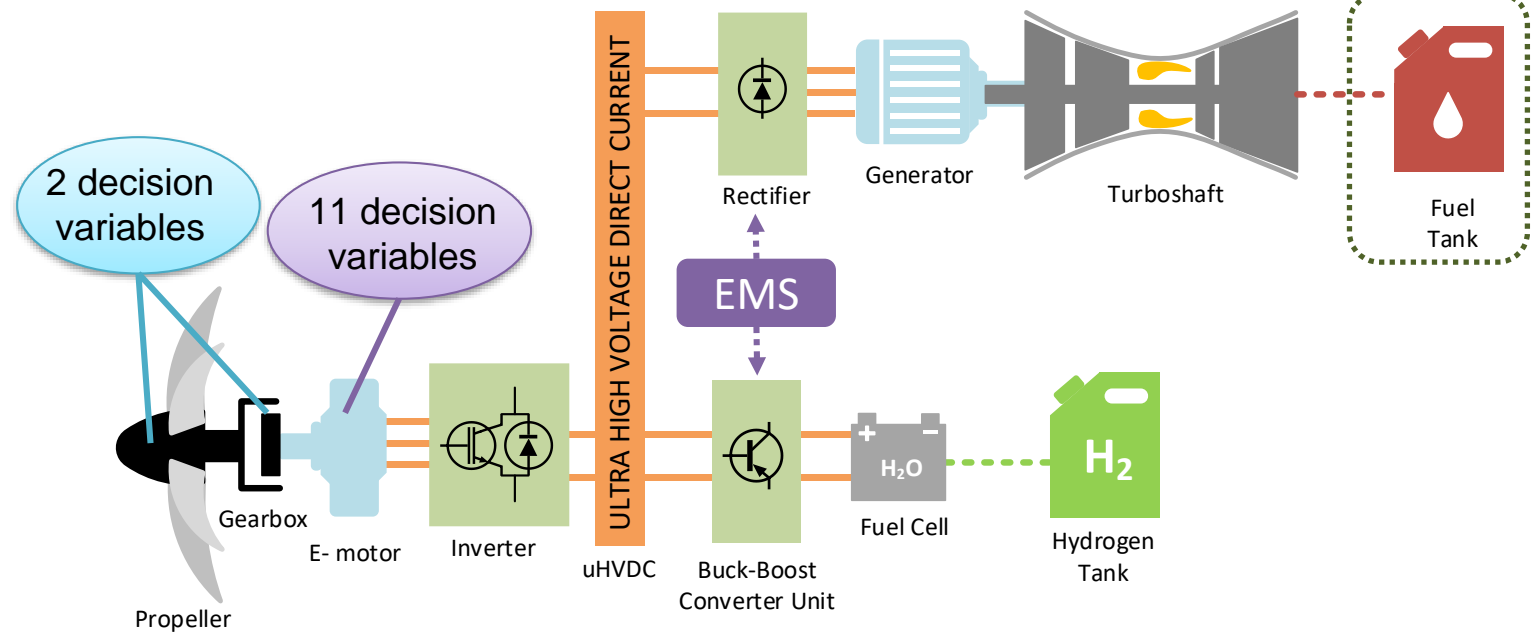
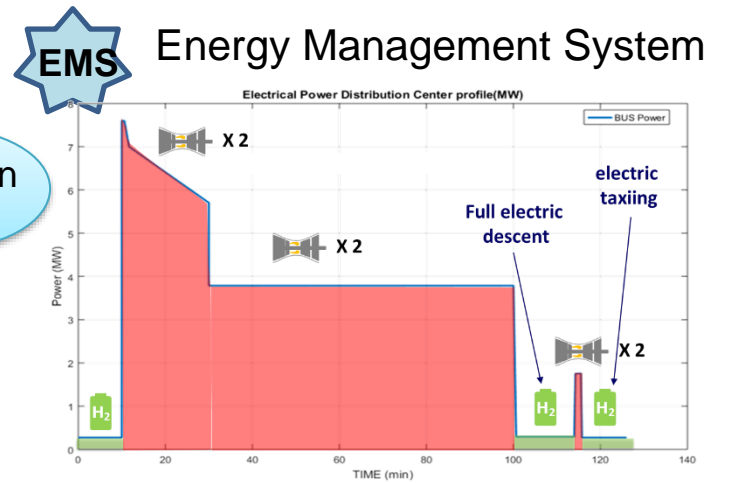
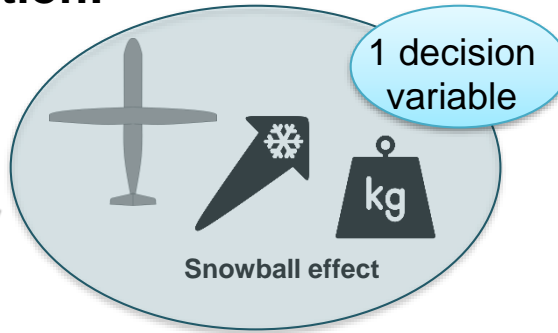

## ➤ Snowball effect: higher device masses cause higher thrust needs with environment couplings

### 3 optimisation formulation:

1. 14 decision variables for fuel burn optimization with “a light hybridization scenario” of EMS

Decision Variables	Name of variables	Lower bound	Upper bound
$R_{Thrust}$	Thrust ratio due to snowball effect	1	1.26
$D_{prop_{siz}}$ [m]	Propeller diameter	2	5
$R_{g_{box}}$ [-]	Gearbox ratio	1	20
$V_{uHVDC}$ [V]	Ultra-high direct current voltage	540	2040
$R_{alesage}$ [m]	Inner radius of the stator	0.05	0.25
$R_{drot_{lm}}$ [%]	Ratio between rotor diameter and active length	50	125
$R_{hs_{ral}}$ [%]	Ratio between stator slot and inner radius	10	150
$R_{g_{ral}}$ [%]	Ratio between the air gap thickness and the inner radius of the stator	1	10
$R_{pm_{ral}}$ [%]	Ratio between the magnet thickness and the inner radius of the stator	5	50
$B_{yoke_{max}}$ [T]	Maximum yoke flux density	1	1.53
$B_{teeth_{max}}$ [T]	Maximum teeth flux density	1	1.53
$N_{ce}$ [-]	Number of conductors per slot	1	4
$n_{ep}$ [-]	Number of slots per poles and per phases	1	3
$p$ [-]	Number of pole pairs	1	7



Optimizer used	CLEARING
Number of runs	~200
Duration	7 days

**Constraints**

- emotor constraints
- emotor cooling constraints
- partial discharges constraints

$$D_{prop_{siz}} \geq D_{prop_{check}}$$

$$MTOW_{new} \leq MTOW_{ref} + 6T$$

$$R_{Thrust} \geq \frac{MTOW_{ref}}{MTOW_{new}} \text{ Snowball effect}$$



MDO CPU time  
(standard computer)  
~ 7 days with clearing

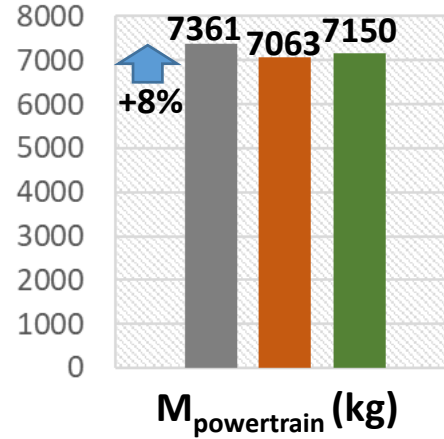
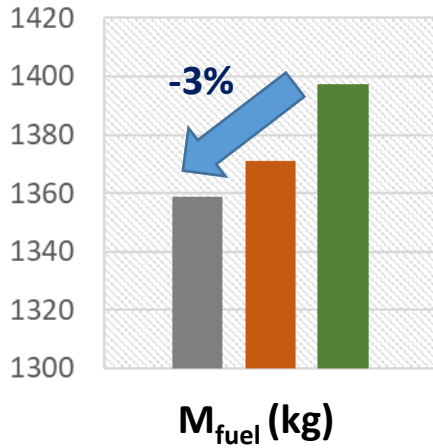

# Some results of the 3 MDO formulations

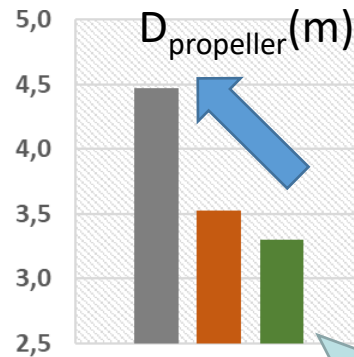

- ① Local optimization —
- ② Powertrain optimization —
- ③ Fuel burn optimization —



**Powertrain efficiency (%)**  
Propeller + gearbox + eMotor + inverter

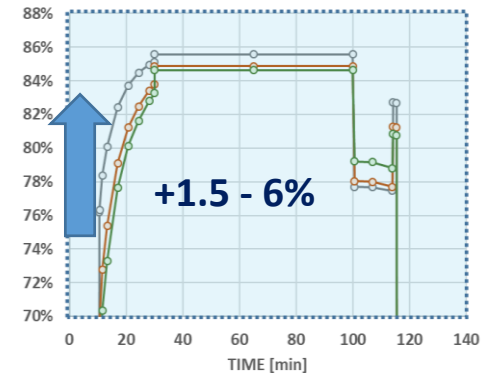

HVDC bus, another strong system coupling

A typical and unexpected systemic coupling: propeller oversizing to increase powertrain efficiency

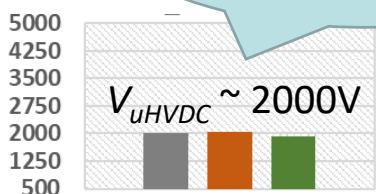

- EMS is a priori set during flight sequences

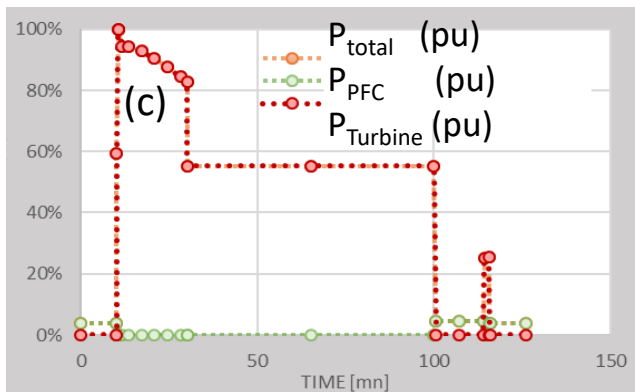
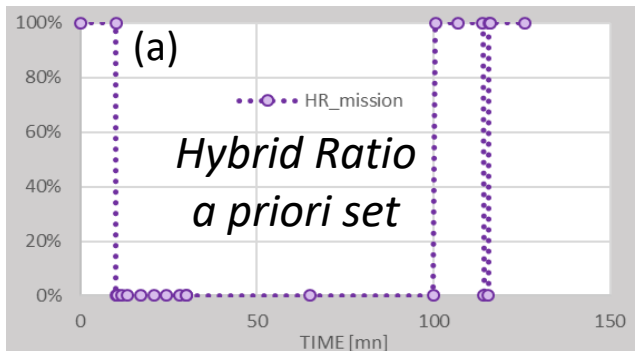
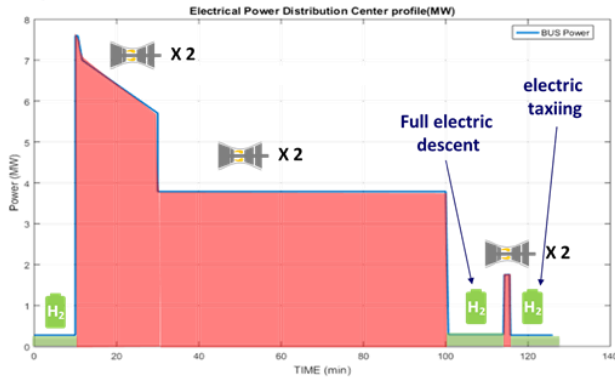

- EMS is optimized: hybrid ratio become additional decision variables

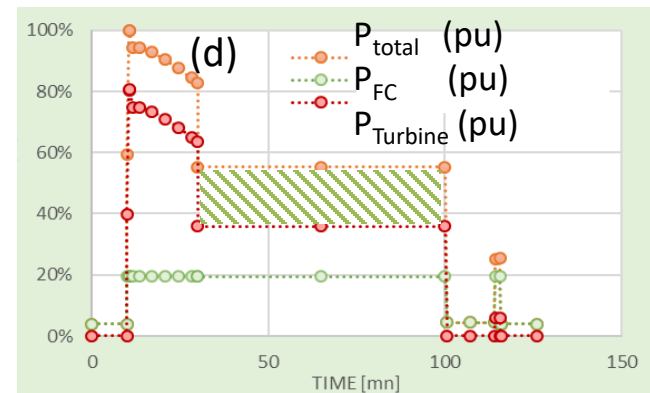
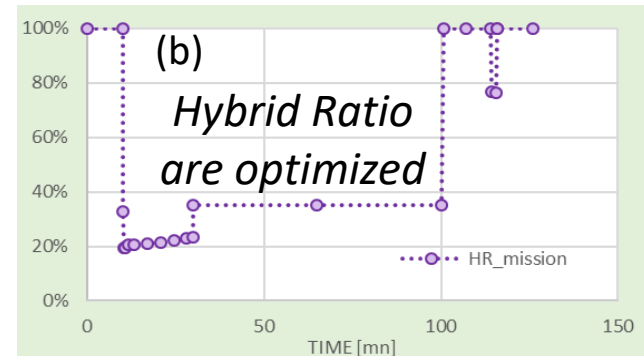

- EMS is a priori set during flight sequences

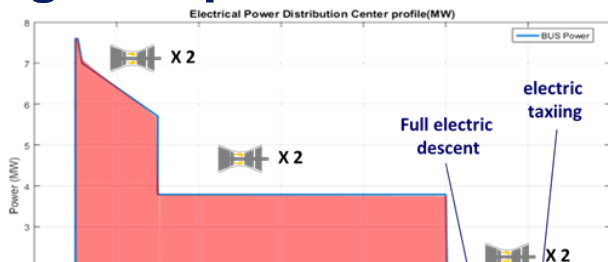

- EMS is optimized: hybrid ratio become additional decision variables

Weights (kg) for 4 power channels

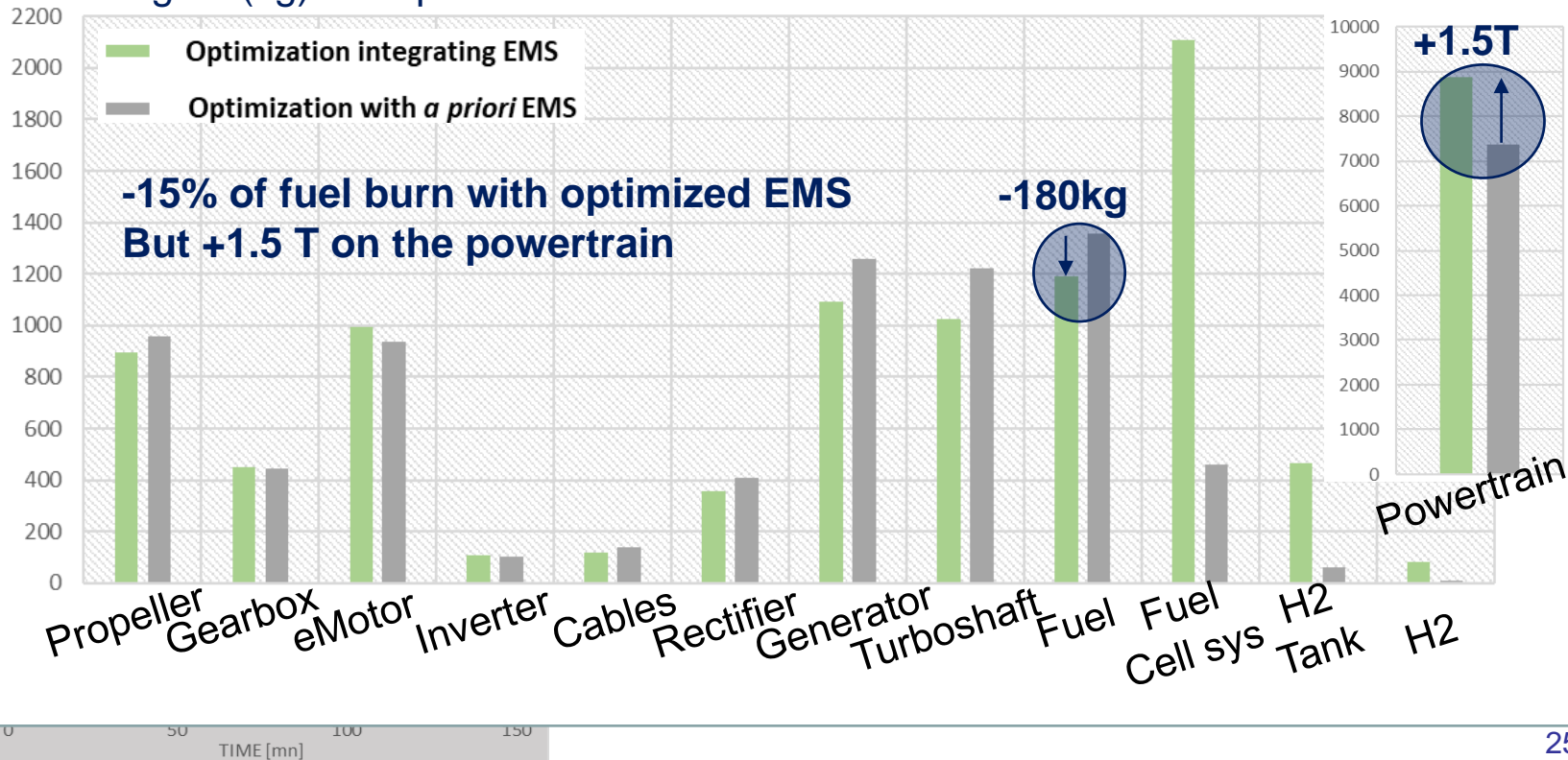

- **Conclusion:** hybrid aircraft with heavier powertrain and potentially "greener" especially cumulating energy gains with aerodynamic benefits due to distributed electric propulsion

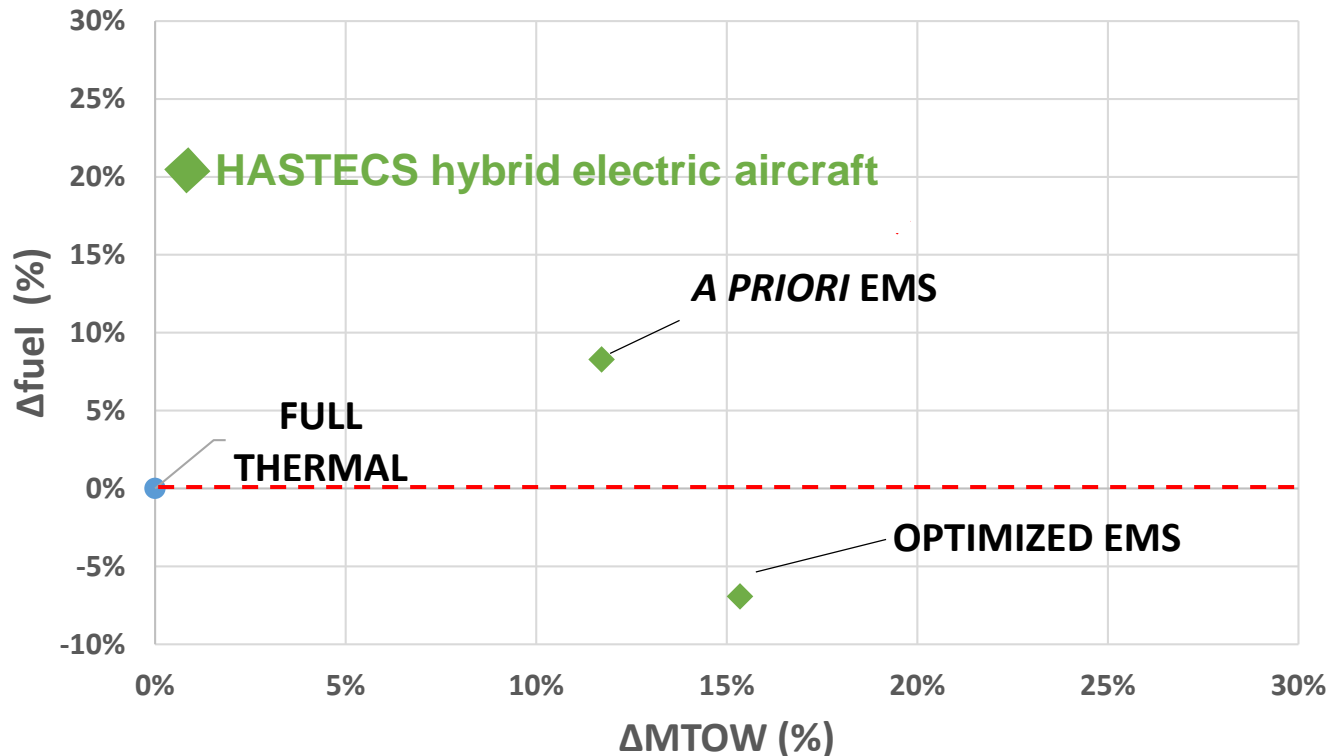

- **Prospect:** the actual breakthrough may be the ZeroE-H2 : with HASTECS models and using same MDO process, the MTOW of a ZeroE H2 should be +25% heavier than an optimized full thermal regional aircraft





# MEA 2021 MORE ELECTRIC AIRCRAFT

Bordeaux, France  
October, 20-21, 2021



## a typical MDO process for future Hybrid Electric aircrafts



**Final dissemination workshop**  
**Oct 27th**

**Free Registration (visioconf)**

[https://www.weezevent.com/hastecs-  
invitation-dissemination-workshop-poitiers-  
october-27th-  
2021?lg\\_billetterie=2&id\\_evenement=752315](https://www.weezevent.com/hastecs-invitation-dissemination-workshop-poitiers-october-27th-2021?lg_billetterie=2&id_evenement=752315)



Université  
de Toulouse

The  Book

**HASTECS: Hybrid Aircraft: reSearch on Thermal  
and Electric Components and Systems**

**Soon available in  
open access (HAL)**



This project has received funding from the [European Union's Horizon 2020  
(cleansky 2 JTI) research and innovation programme, 2014-2024] under grant  
agreement No 715483

**Oct 20th 2021**