



HAL
open science

A Rotor Speed and Load Torque Observer for PMSM Based on Extended Kalman Filter

Zedong Zheng, Yongdong Li, Maurice Fadel, Xi Xiao

► **To cite this version:**

Zedong Zheng, Yongdong Li, Maurice Fadel, Xi Xiao. A Rotor Speed and Load Torque Observer for PMSM Based on Extended Kalman Filter. 2006 IEEE International Conference on Industrial Technology, Dec 2006, Bombay, India. pp.233-238, 10.1109/ICIT.2006.372295 . hal-03548952

HAL Id: hal-03548952

<https://ut3-toulouseinp.hal.science/hal-03548952>

Submitted on 31 Jan 2022

HAL is a multi-disciplinary open access archive for the deposit and dissemination of scientific research documents, whether they are published or not. The documents may come from teaching and research institutions in France or abroad, or from public or private research centers.

L'archive ouverte pluridisciplinaire **HAL**, est destinée au dépôt et à la diffusion de documents scientifiques de niveau recherche, publiés ou non, émanant des établissements d'enseignement et de recherche français ou étrangers, des laboratoires publics ou privés.

A Rotor Speed and Load Torque Observer for PMSM Based on Extended Kalman Filter

Zheng Zedong^{1,2}, Li Yongdong², Maurice Fadel¹, Xiao Xi²

1. LEEI, Insitute National Polytechnique, Toulouse, France
2. Dept. Electrical Engineering, Tsinghua University, Beijing, China
E-mail: zheng@leei.enseeiht.fr

Abstract- This paper proposed a state observer based on extended kalman filter (EKF) for the rotor speed and load torque observation of permanent magnet synchronous motor (PMSM). This observer can be used to estimate the precise rotor position and rotor speed in the servo systems with only optical encoder of limited accuracy. By using the observed rotor speed and position instead of the values got directly from the encoder, the speed and position control performances can be greatly improved. The observer can also give the load torque which can be used as the feedforward compensation of the speed PI controller. The compensation can greatly improve the speed control performance during load torque change. The extended Kalman filter is used to solve the nonlinear equation of the observer, considering the influence of the parameter errors and the noise in measurement. So it is very robust to the parameter errors.

Key words- Load torque, state observer, extended Kalman filter, optical encoder, PMSM

I. INTRODUCTION

The permanent magnet synchronous motor (PMSM) is becoming more and more popular in servo systems because of its high power density, large torque to inertia ratio and high efficiency. In order to obtain high speed and position control performance, a high accuracy position sensor is usually needed. But in many fields, this kind of rotor position sensor is too expensive to use. Some control systems with low-precision position sensors have been proposed in reference [1] and [2], but the performances cannot meet the necessary of the servo system. Usually an optical encoder is used to measure the rotor position by giving a fixed number of pulses in each rotation. The rotor position can be obtained by counting the number of the encoder pulses during the detection time, then the speed can be got by the differential of the position. Since the output of the encoder is quantization pulse, in the low speed region the pulse numbers got from the encoder in one detection period become few, the accuracy of the speed estimation is limited, sometimes very large errors and differential noises are generated. Some references have proposed some filters to get off the noise with little phase lag, but it is too complex to use in practice. [3]

In the servo systems, the variation of the load torque can create some ripples in the rotor speed. In order to make the speed stable during load torque changes, the information of the load torque is needed to compensate the reference torque. As the torque sensor is too expensive, a state observer with the

rotor position, speed and load torque as the state variables is considered to be a good solution for these problems.

Some state observers have been proposed in reference [4] and [5]. Since the output of the encoder is used directly, the low speed performance is limited. The observer in [6] needs to measure rotor speed accurately and quickly. Observers based on Kalman filter are proposed in [7] and [8]. The observer in [7] has too large amount of calculation to be used in practice, Reference [8] doesn't give the results of load torque observation and feedforward compensation. A newly observer based on extended Kalman filter (EKF) is proposed in this paper. Compared with the Kalman filter and state observer, the EKF can solve nonlinear equation directly. The Kalman filter considers the influence of the errors of the system parameters and the disturbance in the measurements of currents and rotor position, so the EKF observer is robust to the system parameters' errors, and can eliminate the noises and errors caused by the quantization of the rotor position in the optical encoder. The feedback gain matrix in EKF is selected based on the optimal control theory, so it can make the observer both stable and convergent quickly.

Some simulation and experiment results of the EKF observer are given in this paper, which show that the observer can get more precise rotor position and speed than the conventional method, also the compensation using the observed load torque can improve the speed performance greatly. It is proved that the control system with the EKF observer is very suitable and effective for the servo system.

II. MODEL OF THE OBSERVER

The mechanical equation of the PMSM is as follows:

$$\begin{aligned} J \frac{d\Omega}{dt} &= T_{em} - f \cdot \Omega - T_L \\ \frac{d\theta}{dt} &= \Omega \end{aligned} \quad (1)$$

Where Ω is the mechanical angle speed, f is the coefficient of friction, J is the inertia, T_{em} is the electromagnetic torque, T_L is load torque, θ is the mechanical rotor position.

In the non-salient PMSM, in the rotor flux oriented coordinates (d,q axis), the electromagnetic torque is given by equation (2).

$$T_{em} = p\psi_d I_q \quad (2)$$

Where p is the number of the poles pairs, Ψ_d is the flux of d -axis, I_q is the current in q -axis. Since we know nothing about the variation of the load torque, we can not get the equation of the load. But we can consider that the load torque changes very slowly compared with the rotor speed and position, that is to assume:

$$dT_L / dt = 0 \quad (3)$$

Based on the former analyses, we can get the state observer for the rotor speed and load torque.^[1]

$$\dot{x} = F \cdot x + B \cdot u + w \quad (4)$$

$$y = C \cdot x + v$$

$$F = \begin{bmatrix} -\frac{f}{J} & 0 & -\frac{1}{J} \\ 1 & 0 & 0 \\ 0 & 0 & 0 \end{bmatrix}, B = \begin{bmatrix} p\Psi_d \\ 0 \\ 0 \end{bmatrix} \quad (5)$$

$$C = [0 \quad 1 \quad 0]$$

$$x = \begin{pmatrix} \Omega \\ \theta \\ T_L \end{pmatrix}, u = I_q$$

Here w and v are the covariance matrixes of the random disturbances. In fact w is the process noise which stands for the error of the parameters; v is the measurement noise which stands for the errors in the measurement and sample.

The noise covariance matrixes are defined as follows:

$$Q = \text{cov}(w) = E\{ww^T\} \quad (6.a)$$

$$R = \text{cov}(v) = E\{vv^T\} \quad (6.b)$$

The system proposed with EKF observer is shown in Fig. 1 where the observed rotor speed, position are used instead of the values got directly from optical encoder, and the observed load torque is used to compensate the reference electromagnetic torque at the output of the speed PI regulator. Some simulations and experiments based on this system have been done.

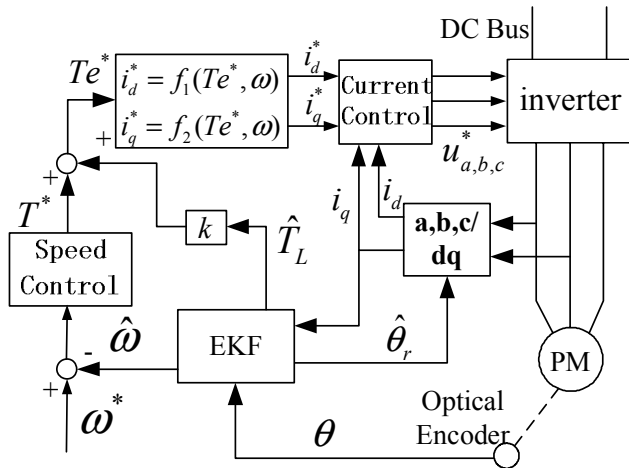

Fig. 1. The flow-chart of the system with state observer

III. SIMULATION RESULTS

In order to test the effects of the proposed observer, some simulations have been done. In the simulation, the control period is $50\mu\text{s}$, the parameters of the motor are as follows:

Rotor resistance $R=0.0176\Omega$, $L=0.000684\text{H}$, the back electromotive force coefficient is $0.0539766 \text{ v}/(\text{rad}/\text{s})$, inertia is $0.0025\text{kg}\cdot\text{m}^2$, poles pairs $p=4$, the friction coefficient f is $0.0609\text{N}\cdot\text{m}/(\text{rad}/\text{s})$. The encoder gives 2500 pulses per rotation.

The rotor position got from the encoder and the real position when the rotor speed is $0.5\pi \text{ rad}/\text{s}$ are shown in Fig. 2. From the results we can see that the number of pulses in one detection period is few in low speed range, so we can not get the precious speed from the optical encoder in every period. If we calculate the rotor speed every 10 periods by the differential of the rotor position got from the encoder, the estimated speed and real speed are shown in Fig.3. The EKF observer can observe the rotor speed in every sampling period. The observed speed is shown in Fig. 4.

Comparing Fig.3 with Fig.4, we can see that the speed obtained by the differential of the rotor position contains a lot of noise, if we use a low-pass filter to eliminate the noise, a phase lag will be produced. But the speed obtained by the EKF observer can match the real speed very well.

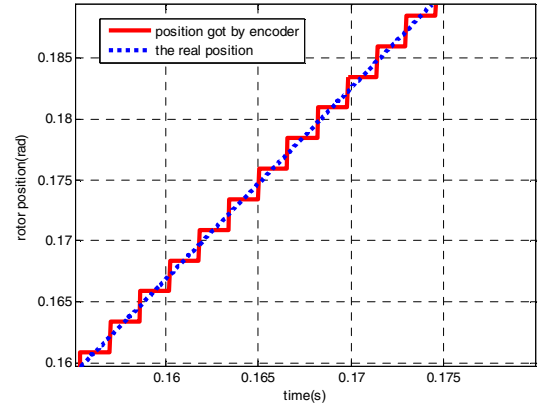

Fig.2. Position got from encoder and real position

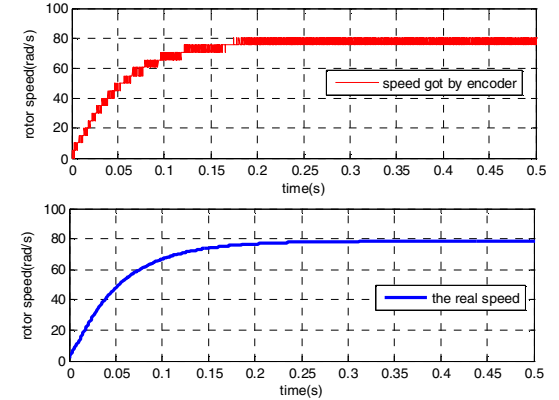

Fig.3. Speed got by differential and real speed

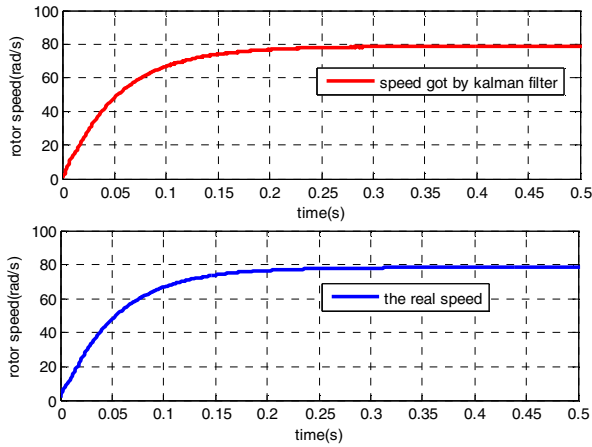

Fig.4. Speed got by observer and real speed

Besides the rotor speed, the EKF observer can also observe the load torque which will have a very great influence to the speed control performance. When the load torque is zero, the observed results of the load torque during the start-up of the motor are shown in Fig.5. At 0.5s, there is a load torque change, the observed load torque is shown in Fig. 6. We can see that the observer can observe the load torque very precisely. Even in the quick dynamic process, the observed torque can track the real torque well.

Once the load torque is observed by the EKF, a feed-forward compensation can be built. The observed load torque is used to compensate the reference torque at the output of the speed PI regulator. This compensation can greatly improve the speed control performance, especially when the load torque varies very quickly.

If there is a load torque sudden change, the motor speeds with and without the load torque feedforward compensation are shown in Fig. 7 and Fig. 8.

When the load torque compensation is added, the speed drop is less than the system without load torque compensation. Because of the lag between the observed torque and real one, the compensation cannot remove all the speed drop during the load change.

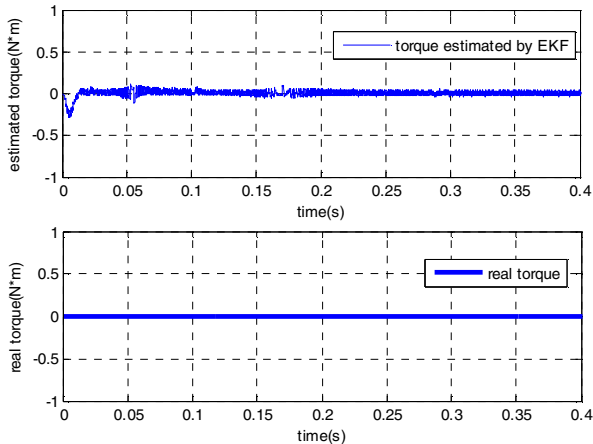

Fig.5.Observed load torque during start-up

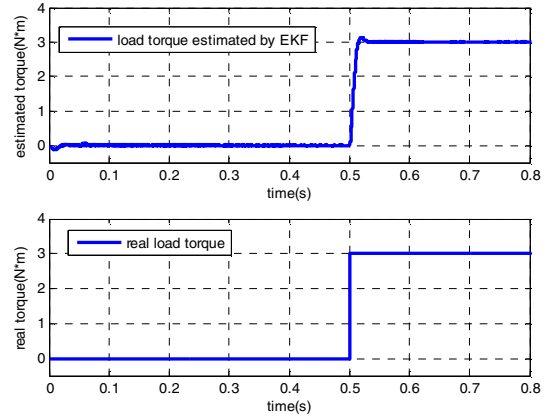

Fig.6. Observed load torque during load torque impact

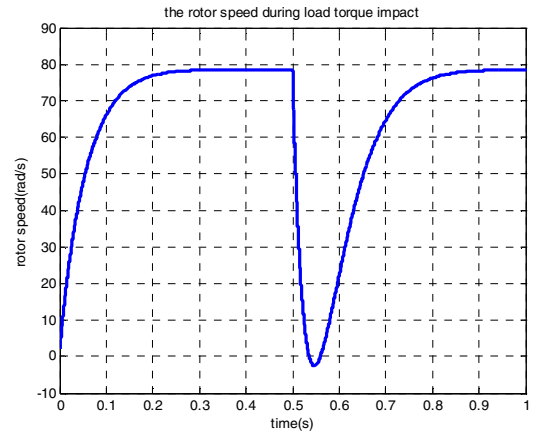

Fig.7. Speed during load sudden change without feedforward compensation

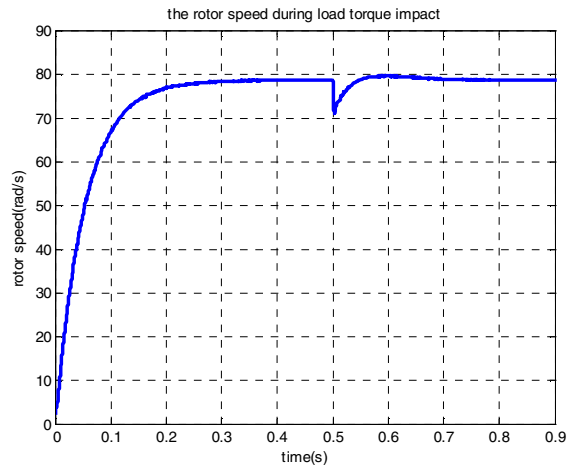

Fig.8. Speed during load sudden change with feedforward compensation

In order to test the robust characters of the EKF observer to the parameters errors, some simulations have been done when the friction coefficient and inertia are not precise. When there is some errors in the coefficient of friction, the part of the friction torque caused by the parameter error will be included in the observed load torque.

Fig. 9 shows the observed load torque when the friction coefficient used in the EKF observer is only 10% of the real one. At 0.5s there is a load torque impact of 3Nm.

If we consider the friction torque as a kind of load torque, the load torque is as follows:

$$T = f \cdot \Omega + T_L \quad (7.a)$$

The estimated load torque is:

$$\hat{T} = \hat{f} \cdot \hat{\Omega} + \hat{T}_L \quad (7.b)$$

Then the observed load torque is the same with the real one even if the friction coefficient is not precise. The simulation results are shown in Fig. 10. The speed control performance is shown in Fig. 11 with the feedforward compensation. It can be seen that when the friction coefficient is not correct, the observed load torque contains parts of the friction torque, which cause some overshoot in the speed control in dynamic process.

When the inertia parameter is 50% of the actual one, the observed load torque is shown in Fig.12. It can be seen that the error of the inertia parameter makes the observed load torque contain some errors in the dynamic process, but in the steady time, the observed load torque agrees with the real one very well. The speed during load torque impact using the observed torque as the feedforward compensation is shown in Fig.13. The error of the inertia make the dynamic performance worse, but it has no influence in the steady state.

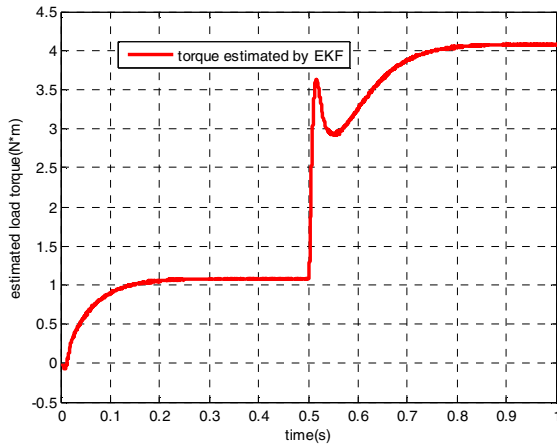

Fig.9. Observed load torque when the friction coefficient is 10% of the actual one

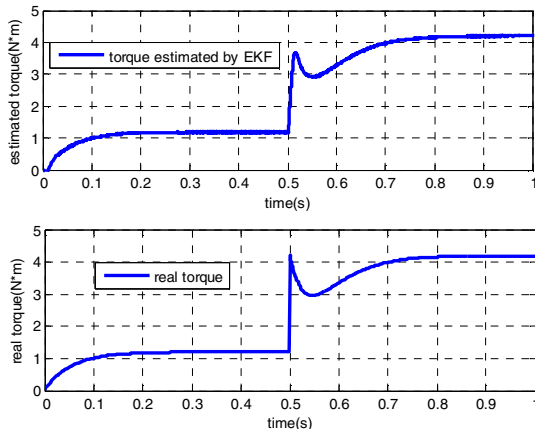

Fig.10. Observed and real load torque containing friction torque

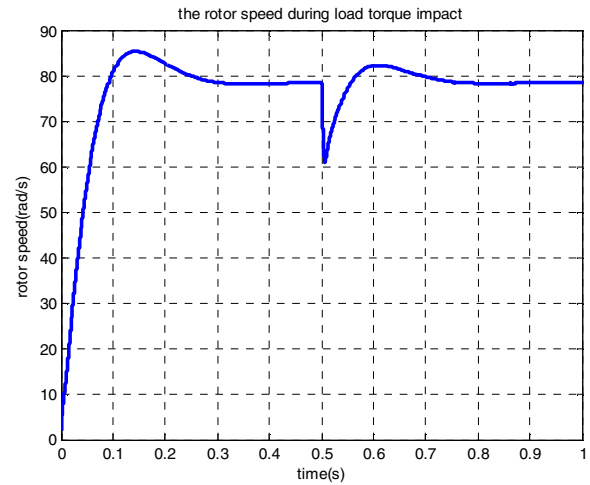

Fig.11. Speed control performance when the friction coefficient is 10% of the actual one

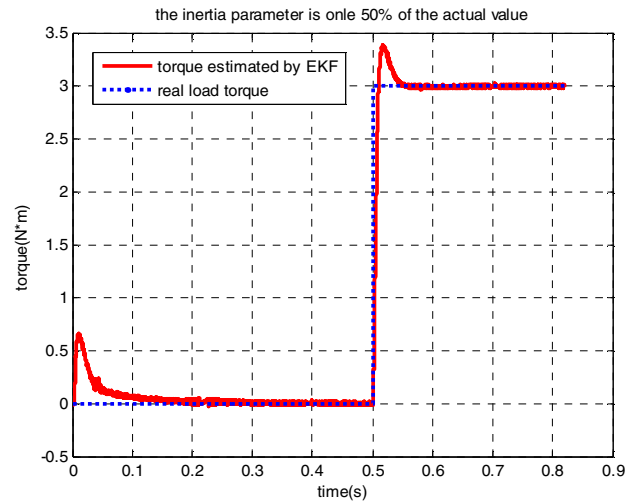

Fig.12. Observed load torque when the inertia parameter is 50% of the actual one

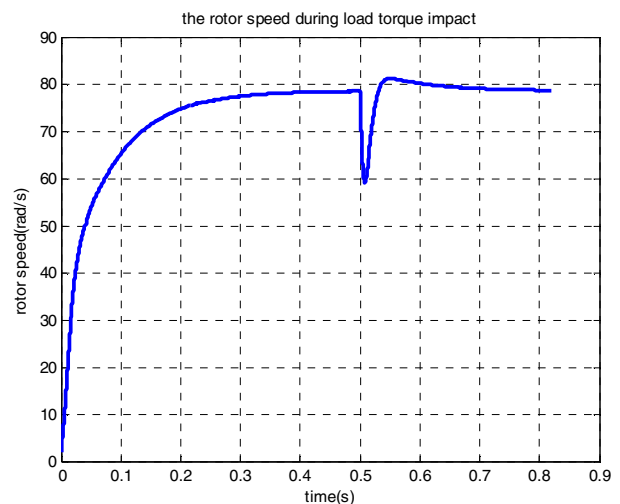

Fig.13. Rotor speed during load impact when the inertia parameter is 50% of the actual one

From the simulations with some parameter errors, it is proved that the observer has a very good robustness to the motor parameters' variation.

IV. EXPERIMENTS RESULTS

To verify the simulation results, some experiments have been done on a motor control platform based on DSP TMS320F2812. The motor parameters are as follows:

$P=750w$, $R=3.69\Omega$, $L=13.22mH$, $J = 0.00943kg*m^2$, $I=3.65A$, poles pairs $p=4$; The optical encoder generates 2500 pulses per rotation. The friction coefficient is unknown, but it is supposed to be $0.0009 N*m/(rad/s)$.

In the experiment system, there are three kinds of speeds. First is the one got from the differential of the rotor position which is the output of the encoder. But in this speed there is a lot of noise especially in the low speed region. To remove the noise, a first order low pass filter is used. The output of the filter is the second kind of speed. The third speed is the observed one by the EKF observer. The experiment results of these speeds are shown in Fig.14. It can be seen that the speed got by the LPF filter has a large lag compared with the observed one. But the observed rotor speed can match the speed got by differential very well even when the latter has a lot of noise.

In experiment, we use the observed rotor speed and position instead of the values got from the encoder directly in the vector control system. The control system used in the experiment is the same as the flowchart of Fig. 1.

If there is no feedforward compensation, the motor speed during load torque impact is shown in Fig.15 when the reference speed is 10Hz. The load torque after impact is 2.1Nm.

In the system with the observed load torque as the feedforward compensation, the speed during a same load torque impact is shown in Fig.16. Because the friction coefficient used in the observer is not the same with the actual one, there is an overshoot similar to the simulation results shown in Fig. 11. In spite of the overshoot, the speed control performance is still better than the situation without the compensation.

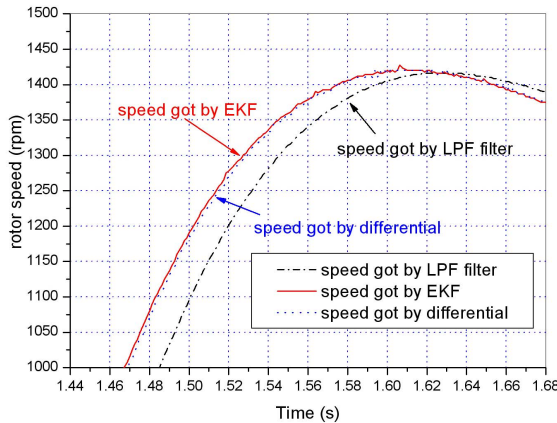

Fig.14. Rotor speed during acceleration

When a load torque of 2.1Nm is applied on the rotor, the load torque observed by the EKF observer is shown in Fig. 17. We cannot get the curve of the real load torque because there is no torque sensor in the platform, but we can compare the estimated load torque with the electromagnetic torque which is shown in Fig. 18. It can be seen that the observed load torque is almost the same with the electromagnetic torque. This can verify the precision of the observer.

Some experiments can also be done when there are errors in the system parameters to detect the robustness of the observer. The observed load torque when the friction coefficient parameter is $0.0001Nm/(rad/s)$ is shown in Fig. 19. And the observed load torque when the inertia parameter is $0.006 kg*m^2$ is shown in Fig. 20.

From the experimental results, we can see that the observer can estimate the rotor speed and load torque exactly. The observed speed has a better precision than the speed got from the direct differential of encoder pulses numbers. By using the observed load torque as the feedforward compensation, the speed control performance can be greatly improved during load torque impact. The observer can improve the speed control precision both in steady and transient state.

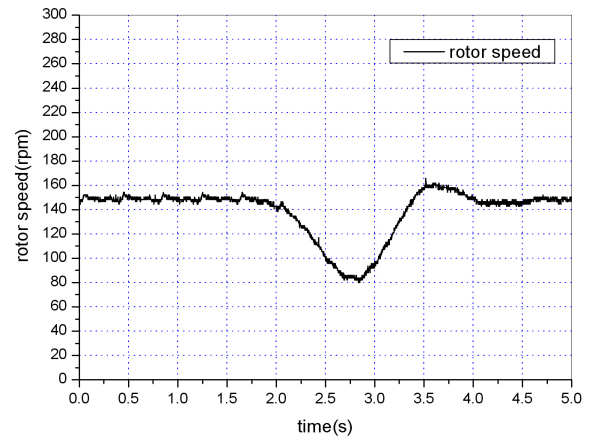

Fig.15. Rotor speed control performance without feedforward compensation

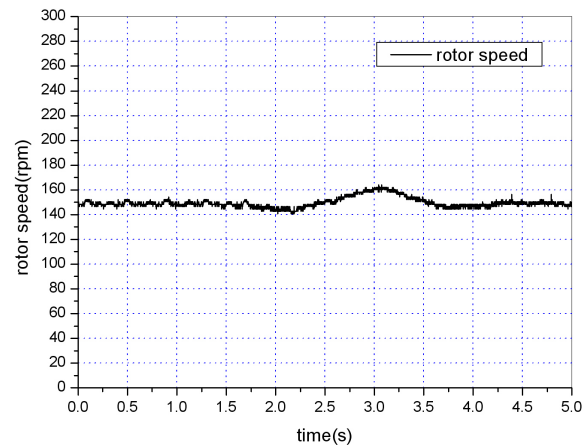

Fig.16. Rotor speed control performance with feedforward compensation

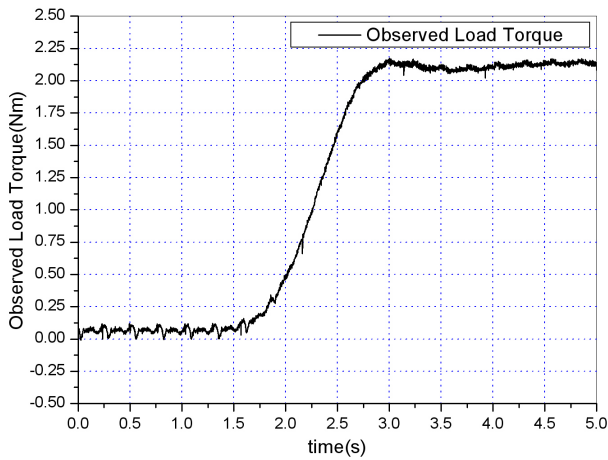

Fig.17. Observed load torque with precise parameters

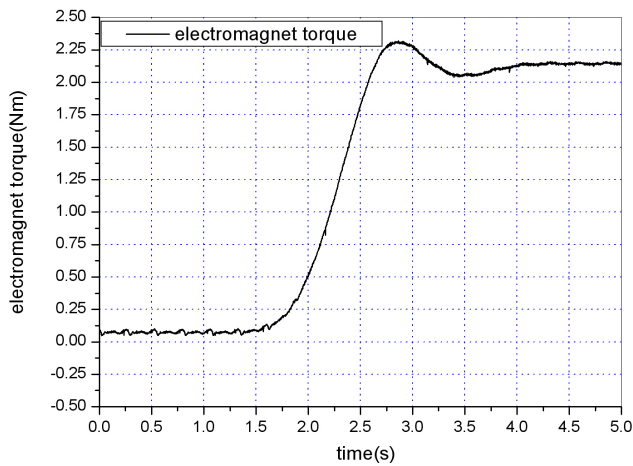

Fig.18. Electromagnetic torque of the motor

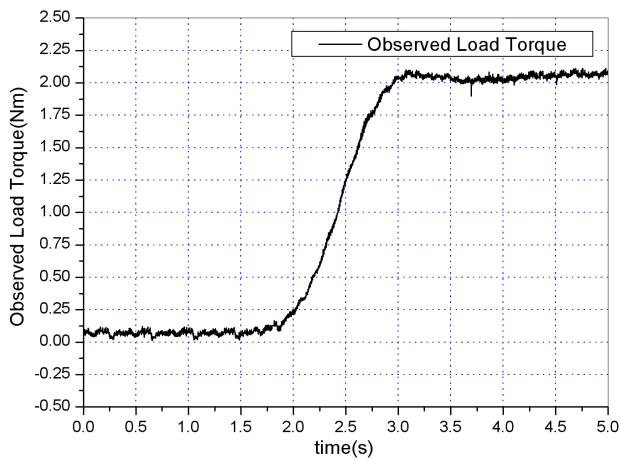

Fig.19. Observed load torque when the parameter f is $0.0001 \text{ Nm/(rad/s)}$ (11.11% of the value used in former)

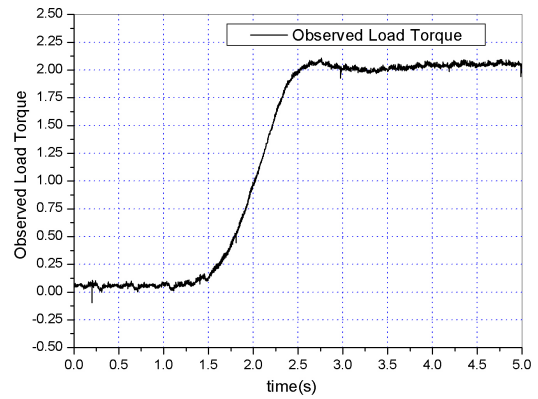

Fig.20. Observed load torque when the parameter J is $0.006 \text{ Kg}\cdot\text{m}^2$ (64% of the actual value)

CONCLUSION

This paper proposed a state observer based on extended Kalman filter. The observer can eliminate the position error caused by the quantization of the optical encoder and obtain the accurate rotor speed in the system. It can overcome the defects of low precision and differential noise in the general speed calculation method. The state observer can also observe the load torque and precise rotor position. By using the observed load torque, a feedforward compensation is built which can greatly improve the speed control performance when the load torque varies suddenly. Generally, the state observer based on extended Kalman filter proposed in this paper is very suitable for the high performance servo systems with low precise rotor position sensor.

REFERENCES

- [1] Todd D. Batzel, and Kwang Y. Lee, "Commutation Torque Ripple Minimization for Permanent Magnet Synchronous Machines with Hall Effect Position Feedback", *IEEE Trans. Energy Conversion*, vol. 13, No.3, pp. 257-261, Sept. 1998.
- [2] Shigeo Morimoto, Masayuki Sanada and Yoji Takeda, "High-performance current drive for PMSM and SynRM with only low-resolution position sensor", *IEEE Trans. Industry Applications*, vol. 39, No. 3, pp. 792-801, May/June 2003.
- [3] Seppo J. Ovaska, "Improving the velocity sensing resolution of pulse encoders by FIR prediction," *IEEE Trans. Instrum. Meas.*, vol. 40, No. 3, pp.657-658, June 1991.
- [4] Robert D. Lorenz, and Keith W. Van Patten, "High resolution velocity estimation for all-digital, ac servo drives," *IEEE Trans. Industry. Applications.*, vol. 27, No. 4, pp.701-705, July/August 1991.
- [5] Guchuan Zhu, Lousi-A. Dessaint, Ouassima Akhrif, and Azeddine Kaddouri, "Speed Tracking Control of a Permanent-magnet Synchronous Motor with State and Load Torque Observer," *IEEE Trans. Industry. Electronics.*, vol. 47, No. 2, pp.346-355, April. 2000.
- [6] L. Gasc, M. Fadel, S. Astier, and L. Calegari, "Load torque observer for minimising torque ripple in PMSM", *in proc. ICEMS 2003*, vol.2, pp.473-476, 2003.
- [6] Taeg-Joon Kweon, and Dong-Seok Hyun, "High-performance speed control of electric machine using low-precision shaft encoder", *IEEE Trans. Power Electronics*, vol. 14, pp. 838-849, Sept. 1999.
- [8] Xu Dianguo, Wang Hong, and Shi Jingzhuo, "PMSM servo system with speed and torque observer", *in proc. PESC '03*, vol.1, pp. 241 - 245, June 2003.