



**HAL**  
open science

# High Performance PMSM Sensorless Control with Load Torque Observation

Zedong Zheng, Maurice Fadel, Yongdong Li

► **To cite this version:**

Zedong Zheng, Maurice Fadel, Yongdong Li. High Performance PMSM Sensorless Control with Load Torque Observation. EUROCON 2007 - The International Conference on "Computer as a Tool", Sep 2007, Varsovie, Poland. pp.1851-1855, 10.1109/EURCON.2007.4400436 . hal-03540997

**HAL Id: hal-03540997**

**<https://ut3-toulouseinp.hal.science/hal-03540997>**

Submitted on 24 Jan 2022

**HAL** is a multi-disciplinary open access archive for the deposit and dissemination of scientific research documents, whether they are published or not. The documents may come from teaching and research institutions in France or abroad, or from public or private research centers.

L'archive ouverte pluridisciplinaire **HAL**, est destinée au dépôt et à la diffusion de documents scientifiques de niveau recherche, publiés ou non, émanant des établissements d'enseignement et de recherche français ou étrangers, des laboratoires publics ou privés.

# High Performance PMSM Sensorless Control with Load Torque Observation

ZHENG Zedong\*, Maurice FADEL\* and LI Yongdong†

\* LAPLACE UMR-CNRS 5213, ENSEEIHT, INP, Toulouse, France,

e-mail: zedong.zheng@laplace.univ-tlse.fr, maurice.fadel@laplace.univ-tlse.fr

† Electrical Engineering Department, Tsinghua University, Beijing, China, e-mail: liyd@tsinghua.edu.cn

**Abstract**—This paper proposes a new state observer based on extended Kalman filter (EKF) for the sensorless control of permanent magnet synchronous motors (PMSM). The observer can obtain exact rotor speed and position with which sensorless control can be achieved. Load torque is also observed and used as the feed-forward compensation to improve the system performance during load torque changes. In this system, the initial rotor position is not necessary for the start up. Based on the observed variables, a state space position control controller is built up. Simulations and experiments have been done to verify the performances of the system.

**Keywords:** permanent magnet synchronous motor, extended Kalman filter, sensorless control, load torque observation, initial position

## I. INTRODUCTION

Permanent magnet synchronous motors (PMSM) are more and more used because of their good performances. High performance control of the PMSM needs the rotor position which is usually measured by a mechanical rotor position sensor. This will increase the cost and the instability of the system. So sensorless control is becoming a research focus recently.

Some sensorless control methods have been proposed before. Generally there are the methods based on back electromotive force (EMF), model reference adaptive system (MRAS) [1] and state observer. Methods based on EMF and MRAS are simple but are greatly depended on the accuracy of the parameters. Method based on state observer is more robust because of the feedback correction, but it is difficult to determine all the feedback gains in order to get both better stability and quicker converging speed. The difference between state observer and Kalman filter is that the feedback gain of Kalman filter is updated automatically by the iteration based on optimal control theory. Extended Kalman filter (EKF) is an extension in the nonlinear system of the linear Kalman filter (LKF). Since the equations of the PMSM are generally nonlinear, EKF is more suitable than linear state observer. Some methods based on EKF have been proposed, most of them are founded in the static two-phases coordinate, since the stator inductances in static two-coordinate of salient PMSM are varying depend on rotor position, they can hardly be used for the salient pole motors. [2][3][4]

In motor control system, the parameters of traditional speed or position regulators are adjusted by supposing load torque as system disturbance and constant. So the

variation of load torque will have some effects on system performance. Feed-forward compensation by the load torque can eliminate the effects. Since the measurement of load torque is difficult and expensive, some load torque observes have been proposed. [5][6][7] Generally a mechanic sensor is also needed in these methods. With the EKF, the observation of load torque is possible without mechanical sensor. [8]

In this paper, a new state observer based on extended Kalman filter is proposed. The precious rotor position and speed can be obtained by EKF. Then a sensorless speed control system can be formed. The EKF observer can observe the load torque at the same time which can be used as the feed-forward compensation of the reference torque at the output of the speed regulator. With the compensation, the speed fluctuations during load torque impacts can be greatly decreased.

In sensorless system, the estimation of the initial position is very difficult, especially for the non-salient motors. The EKF observer can track the real rotor position quickly during start up in despite of the initial position errors. So the initial position measurement or estimation can be got rid of in this system. In spite of some small reverse when the initial position error is large, this start method is simple and can be used in many fields. Based on the observed rotor speed, position and load torque, a state space position controller is built up which can get an excellent position control performance. [9] Some simulations and experiments have been done to verify the performances of the proposed system.

## II. OBSERVER BASED ON EKF

In the rotor flux oriented synchronous coordinate (d,q coordinate), stator voltage equations of PMSM are shown in (1) and (2).

$$U_d = RI_d + L_d \frac{dI_d}{dt} - \omega L_q I_q \quad (1)$$

$$U_q = RI_q + L_q \frac{dI_q}{dt} + \omega L_d I_d + \omega \psi_r \quad (2)$$

Here  $U_d$  and  $U_q$  are stator voltages in dq axes.  $I_d$  and  $I_q$  are stator phase currents.  $L_d$  and  $L_q$  are stator inductances,  $R$  is stator resistance.  $\omega$  is rotor electrical angle speed.  $\psi_r$  is rotor flux amplitude on d axes. In rotor flux oriented synchronous coordinate,  $L_d$  and  $L_q$  are constants, so the observers built on synchronous coordinates are more suitable for the salient PMSM.

In this paper, we use surface mounted PMSM, there is:

$$L_d = L_q = L. \quad (3)$$

The equations of the rotor speed and position are:

$$J \frac{d\Omega}{dt} = T_{em} - f \cdot \Omega - T_L. \quad (4)$$

Here  $J$  is the inertia,  $\Omega$  is rotor mechanic angle speed,  $T_{em}$  is the electromagnetic torque,  $f$  is the coefficient of friction torque.  $T_L$  is load torque. If we use electrical angle speed instead, (4) can also be written as:

$$J \frac{d\omega}{dt} = p^2 \cdot \psi_r \cdot I_q - f \cdot \omega - p \cdot T_L. \quad (5)$$

$$\text{Here } T_{em} = p \cdot \psi_r \cdot I_q. \quad (6)$$

The load torque is supposed to change slowly compared with other state variables, and its derivation is zero.

$$\frac{dT_L}{dt} = 0. \quad (7)$$

If we use d,q currents, rotor speed, rotor position and load torque as state variables, the state equations can be shown as (8).

$$\begin{cases} \frac{dI_d}{dt} = \frac{U_d}{L} - \frac{I_d}{\tau} + \omega \cdot I_q \\ \frac{dI_q}{dt} = \frac{U_q}{L} - \frac{I_q}{\tau} - \omega \cdot I_d - \frac{K_e}{L} \cdot \omega \\ \frac{d\omega}{dt} = \frac{p^2 \cdot \psi_r}{J} \cdot I_q - \frac{f}{J} \cdot \omega - \frac{p}{J} \cdot T_L \\ \frac{d\theta}{dt} = \omega \\ \frac{dT_L}{dt} = 0 \end{cases} \quad (8)$$

$\theta$  is rotor flux position.  $\tau = L/R$  is stator electrical constant.

The output matrix is as follows:

$$y = [I_d \ I_q]^T \cdot C \cdot x. \quad (9a)$$

$$\text{With } x = [I_d \ I_q \ \omega \ \theta \ T_L]^T; \quad (9b)$$

$$C = \begin{bmatrix} 1 & 0 & 0 & 0 & 0 \\ 0 & 1 & 0 & 0 & 0 \end{bmatrix}. \quad (9c)$$

Considering the noises and parameter errors, the state equations for PMSM can be written as (10).

$$\begin{cases} \dot{x} = g(x, u) + w \\ y = C \cdot x + v \end{cases} \quad (10)$$

Here  $w$  and  $v$  are the random disturbances and noise. In fact  $w$  is the process noise which stands for the errors of the parameters;  $v$  is the measurement noise which stands for the errors in the measurement and sample.

The noises covariance matrixes are defined as follows:

$$Q = \text{cov}(w) = E\{ww^T\}; \quad (11a)$$

$$R = \text{cov}(v) = E\{vv^T\}. \quad (11b)$$

$E\{\cdot\}$  is the computation of expectation value.

Extended Kalman filter can be built as follows:

$$x(k+1) \quad f = x(k) + g(x, u) \cdot T_e; \quad (12)$$

$$F = \frac{\partial f}{\partial X} = \begin{bmatrix} 1 - \frac{T_e}{\tau} & T_e \omega & T_e I_q & 0 & 0 \\ -T_e \omega & 1 - \frac{T_e}{\tau} & T_e (-I_d - \frac{\psi_r}{L}) & 0 & 0 \\ 0 & T_e \frac{p^2 \psi_r}{J} & 1 - \frac{f}{J} T_e & 0 & -\frac{p}{J} T_e \\ 0 & 0 & T_e & 1 & 0 \\ 0 & 0 & 0 & 0 & 1 \end{bmatrix}. \quad (13)$$

EKF can be realized by the iteration as follows:

1. Compute state ahead and error covariance ahead.

$$\hat{x}_{k|k-1} = \hat{x}_{k-1|k-1} + g(\hat{x}_{k-1|k-1}) \cdot T_e \quad (14a)$$

$$P_{k|k-1} = F_{k-1} P_{k-1|k-1} F_{k-1}^T + Q_{k-1} \quad (14b)$$

2. Compute the Kalman gain.

$$K_k = P_{k|k-1} \cdot C^T \cdot (C \cdot P_{k|k-1} \cdot C^T + R_{k-1})^{-1} \quad (15)$$

3. Update estimate with measurement.

$$\hat{x}_{k|k} = \hat{x}_{k|k-1} + K_k (y_k - C \cdot \hat{x}_{k|k-1}) \quad (16)$$

4. Update the error covariance matrix.

$$P_{k|k} = [I - K_k \cdot C] \cdot P_{k|k-1} \quad (17)$$

Matrix  $P$  is the error covariance of estimation.

$$P_{k|k} = E\{e_k^T \cdot e_k\} = \sum_{i=1}^n E\{[x_i - \hat{x}_i][x_i - \hat{x}_i]^T\} \quad (18)$$

Compared with EKF, the traditional state observer is calculated as follows:

$$\hat{x}_k = \hat{x}_{k-1} + g(\hat{x}_{k-1}) \cdot T_e + K (y - C \hat{x}_{k|k-1}) \quad (19)$$

Generally the feedback gains of state observer are constants or updated artificially, and the initial values of the feedback matrix are also hard to be known well. But the feedback gain of EKF is obtained by iteration and no initial values are needed.

Because there are many matrix calculations in the iteration of EKF, the computation take quite a lot of time. In practice, matrixes Q and R are diagonal, and we can set the initial values of matrix P as diagonal matrix too. Then we can know that matrix  $P_{k|k-1}$  and  $P_{k|k}$  are always symmetric during iteration. There are also some repeated computations during iteration, so computation can be reduced greatly by optimization of the calculation.

Since the measurement of the terminal voltages of the motors driven by a PWM inverter is very difficult and expensive. So the reference voltages are used instead.

During load torque changes, there are usually corresponding speed fluctuations, which are determined by the inherent characters of the PI regulator. Since the load torque is observed by EKF, we can use the observed load torque as feed-forward compensation of reference torque. Before the compensation, a low-pass filter is used in order to make the system stable. Based on extended Kalman filter, the sensorless control system is shown in Fig.1. The rotor flux oriented vector control is adopted. The d-axis current is controlled to be zero which can get the largest torque with smallest phase currents.

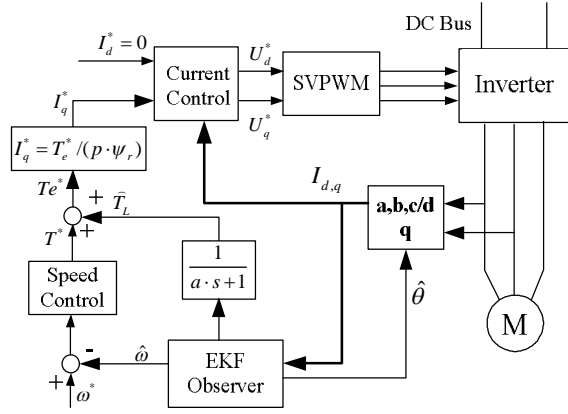

Fig. 1. Flow-chart of the sensorless system

### III. SIMULATION RESULTS

Some simulations have been done in MATLAB Simulink to verify the performance of the system. The parameters of the system are shown in TABLE 1.

When there are some initial position errors ( $\pi/3$ ), the rotor speed and position estimation errors are shown in Fig. 2 and Fig. 3. It can be seen that the initial position error causes some errors in the speed and position estimation at the beginning, but the extended Kalman filter can track the real values very quickly.

When the motor starts up at 0s, and there is some load torque impact at 1s, the observed and real load torque is shown in Fig. 4. It can be seen that the observed load torque can track the real torque very well.

TABLE I.  
PARAMETERS OF THE SYSTEM

Parameters	Values
Stator inductance $L_d = L_q = L$	0.00125 H
Stator phase resistance R	0.155 $\Omega$
Rotor magnet flux $\psi_r$	0.153093 Web
Inertia $J$	0.07 Kg·m <sup>2</sup>
Coefficient of friction $f$	0.0826 N·m/(rad/s)
Number of pole pairs p	4

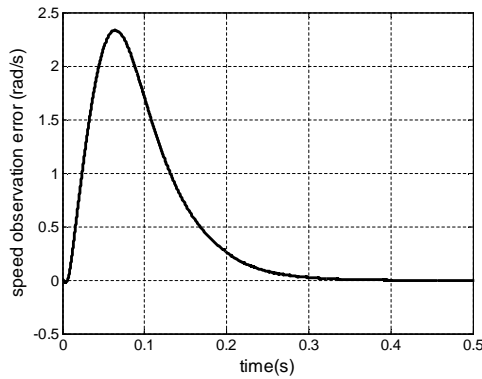

Fig. 2. Speed observation errors (simulation)

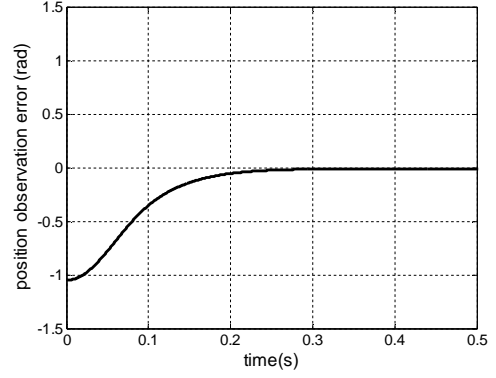

Fig. 3. Flux position observation errors (simulation)

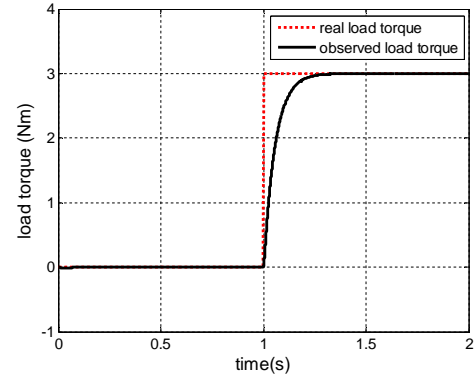

Fig. 4. Observed and real load torque (simulation)

### IV. EXPERIMENT RESULTS

Experiments have been done on a platform with the DSP C6711 as the controller. The parameters of the motor are the same as shown in TABLE 1. In fact we don't know the coefficient of friction and inertia exactly.

In the extended Kalman filter, the  $Q$  and  $R$  matrixes are set as follows:

$$Q = \begin{bmatrix} 0.1 & & & \\ & 0.1 & & \\ & & 0.1 & \\ & & & 0.1 \end{bmatrix}, R = \begin{bmatrix} 1.0 & \\ & 1.0 \end{bmatrix}. \quad (20)$$

The matrix  $P$  is set as:

$$P_{00} = \begin{bmatrix} 0.1 & & & \\ & 0.1 & & \\ & & 0.1 & \\ & & & 0.1 \end{bmatrix}. \quad (21)$$

The initial values of the state variables are all zeros.

The estimated rotor speed during acceleration is shown in Fig. 5. Because we use a rotor position sensor of 256 points every cycle to measure the rotor position and speed, there is some noise in the measured rotor speed. The estimated rotor speed can track the measured speed very well and there are almost no noises in the estimated rotor speed.

The load torque observation result is shown in Fig. 6. There are some static errors in the load torque estimation which is caused by the error in the coefficient of friction.

The observed load torque can be used as the feed-forward compensation. If we use the load torque impacts of the same value, rotor speeds with and without compensations under the same speed controller parameters are shown in Fig. 7 and Fig. 8. It is obvious that the feed-forward compensation of the observed load torque can greatly improve rotor speed control performance, especially during load torque changes. The speed fluctuates can be decreased greatly and the speed response can be more rapid.

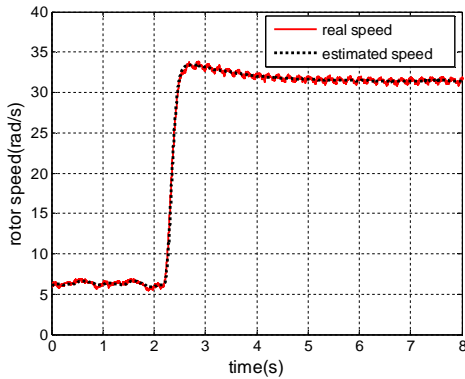

Fig. 5. Real and estimated rotor speed

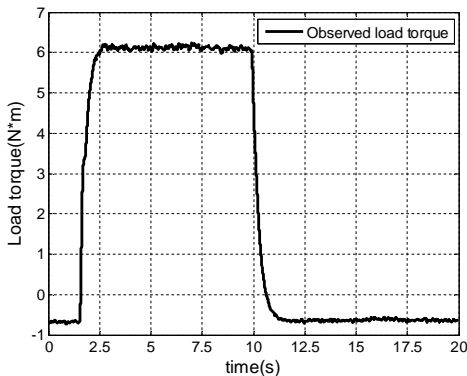

Fig. 6. Observed load torque during load torque impact

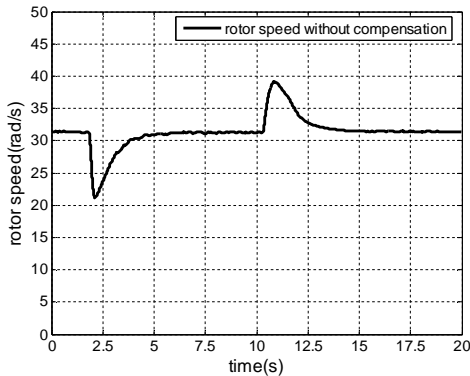

Fig. 7. Rotor speed during load impact without compensation

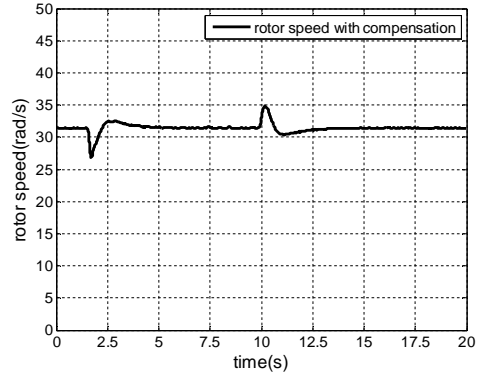

Fig. 8. Rotor speed during load impact with compensation

In the traditional control method of PMSM, the initial rotor position is needed for the start up. The initial position sensor increases the cost of the system. A method is proposed to measure the initial rotor position in [1]. But it is difficult to be used in non-salient motors. Another method is to make the rotor to be fixed at some desired initial position using some DC voltage or DC current. But the system inertia and the load characters limit the use of this method.

In this sensorless system, the motor can start up at any unknown initial rotor positions. During start-up, the estimated rotor position can track the real position quickly. Then the motor can start up successfully from any unknown rotor initial position. The rotor position estimation results during start-up are shown in Fig. 9 and Fig. 10. Since the rotor position sensor hasn't a very good precision, there is some noise in the measured rotor position.

Sometimes there are the reverses during start up, especially when the initial position errors are large (larger than  $\pi/2$ ), but the motor can run towards the correct direction quickly after the estimated rotor position track the real position. So in this system, the initial rotor position measurement or estimation is not needed. This method is simple and efficient, and can be used some fields where a rigorous start performance isn't desired.

The phase current of the motor during start up is shown in Fig. 11. It can be seen that there is no attacks in phase currents during start up.

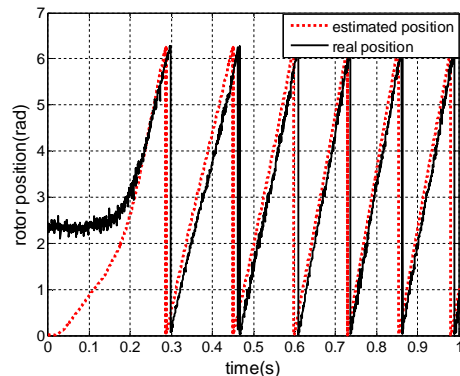

Fig. 9. Rotor position estimation results during start up

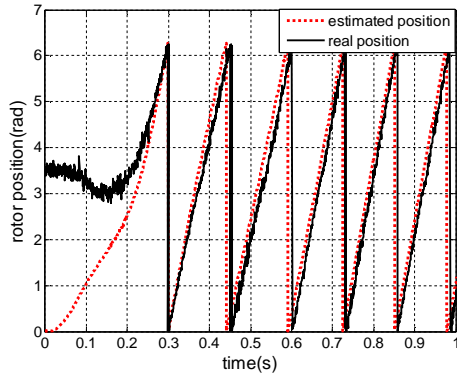

Fig. 10. Rotor position estimation results during start up

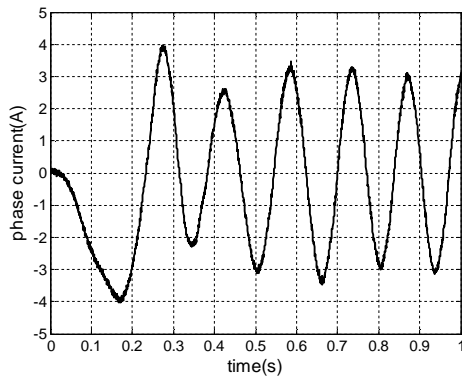

Fig. 11. Phase current during start up

Based on the observed rotor position, rotor speed and load torque, a state space position controller is performed. The principal of the controller is introduced in [9] and the structure is shown in Fig. 12. The actuator consists of the current controller, inverter and motor which are already shown in Fig. 1. The position control result is shown in Fig. 13. The corresponded rotor speed is shown in Fig. 14.

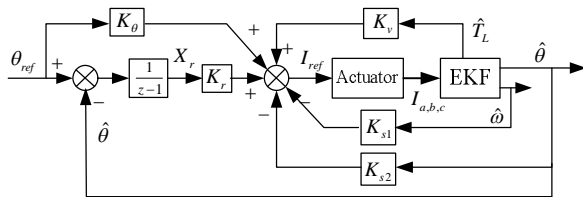

Fig. 12. Structure of the state space controller

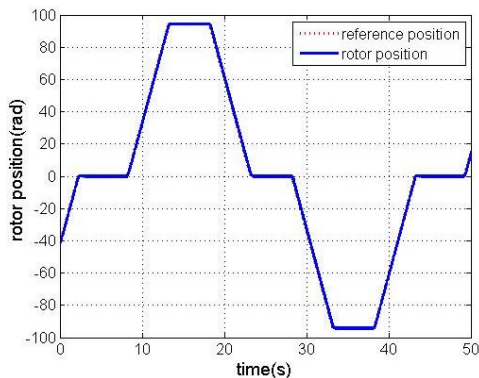

Fig. 13. Position control results

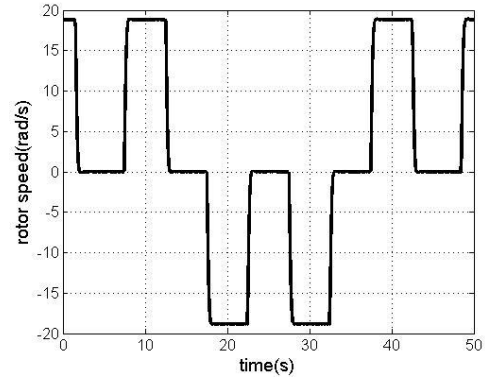

Fig. 14. Corresponded rotor speed

It shows that the state space position controller can get a better performance than the traditional PID controller.

## V. CONCLUSIONS

The observer based on extended Kalman filter can observe the exact rotor speed, position and load torque. The observed load torque can be used as the feed-forward compensation of the reference torque. The compensation can greatly improve the speed control performance with load torque impacts. The extended Kalman filter can track the real rotor position quickly during start-up in spite of the existence of the initial position error. So the motor can start up at any unknown initial position. A stator space position controller is built up with the observed speed, position and load torque. An excellent rotor control performance can be got by the controller. Simulation and experiments have proved that this system is a very good sensorless control system for PMSM.

## REFERENCES

- [1] Yan Liang and Yongdong Li, "Sensorless Control of PM Synchronous Motors Based on MRAS Method and Initial Position Estimation," *ICEMS 2003*, Volume 1, 9-11 Nov. 2003 pp:96 – 99
- [2] S. Bolognani, R. Oboe, and M. Zigliotto, "Dsp-based extended kalman filter estimation of speed and rotor position of a PM synchronous motor", in *Proc. IECON '94.*, vol. 3, pp. 2097 - 2102, Sept. 1994
- [3] Silverio Bolognani, Luca Tubiana, and Mauro Zigliotto, "Extended Kalman filter tuning in sensorless PMSM drives," *IEEE Trans. Ind. Applicat.*, vol. 39, No. 6, pp. 276-281. Nov./Dec. 2003
- [4] Rached Dhaouadi, Ned Mohan, and Lars Norum, "Design and Implementation of an Extended Kalman Filter for the State Estimation of a Permanent Magnet Synchronous Motor," *IEEE Trans. Power Electron.* vol. 6. No. 3. pp. 491-497, July 1991.
- [5] L. Gasc, M.Fadel, S. Astier, and L. Calejari, "Sensorless control for PMSM with reduced order torque observer associated to Kalman filter," in *Proc. EPE 2005*, 11-14 Sept. 2005.
- [6] Xu Dianguo, Wang Hong, and Shi Jingzhuo, "PMSM servo system with speed and torque observer," in *proc. PESC '03*, vol.1, pp. 241 – 245, June 2003.
- [7] Guchuan Zhu, Lousi-A. Dessaint, Ouassima Akhrif, and Azeddine Kaddouri, "Speed Tracking Control of a Permanent-magnet Synchronous Motor with State and Load Torque Observer," *IEEE Trans. Ind. Electron.*, vol. 47, No. 2, pp346-355, April. 2000.
- [8] Dariusz Janiszewski, "Extended Kalman Filter Based Speed Sensorless PMSM Control with Load Reconstruction," in *Proc. IECON '06*, pp.1465-1468, Nov. 2006.
- [9] Maurice FADEL, "Position control laws for electromechanical actuator," *ICEMS '05*, pp.1708-1713, Sep. 2005.