



HAL
open science

A High-Performance Control System of PMSM Based on Load Torque Observer

Zedong Zheng, Maurice Fadel, Yongdong Li

► **To cite this version:**

Zedong Zheng, Maurice Fadel, Yongdong Li. A High-Performance Control System of PMSM Based on Load Torque Observer. 2007 IEEE Power Electronics Specialists Conference (PESC), Jun 2007, Orlando, United States. pp.587-592, 10.1109/PESC.2007.4342053 . hal-03540854

HAL Id: hal-03540854

<https://ut3-toulouseinp.hal.science/hal-03540854>

Submitted on 24 Jan 2022

HAL is a multi-disciplinary open access archive for the deposit and dissemination of scientific research documents, whether they are published or not. The documents may come from teaching and research institutions in France or abroad, or from public or private research centers.

L'archive ouverte pluridisciplinaire **HAL**, est destinée au dépôt et à la diffusion de documents scientifiques de niveau recherche, publiés ou non, émanant des établissements d'enseignement et de recherche français ou étrangers, des laboratoires publics ou privés.

A High-Performance Control System of PMSM Based on Load Torque Observer

ZHENG Zedong^{1,2}, Maurice FADEL¹, LI Yongdong²

1. Lab. LAPLACE UMR-CNRS 5213, INP-ENSEEIH, Toulouse, France
2. Department of Electrical Engineering, Tsinghua University, Beijing, China

Abstract- A load torque observer based on Kalman filter is proposed which can observe the load torque, rotor speed and position of permanent magnet synchronous motors (PMSM) with only very low accuracy mechanical position sensor. With the observed rotor position and speed instead of the values measured directly from mechanical sensor, control performance can be greatly improved and the cost of the system can be decreased. Observed load torque can be used as feedforward compensation which can eliminate the effects of load torque changes. Then, a state space position controller is formed which can get a better position control performance than traditional method.

Key words- Load torque observer, Kalman filter, PMSM, state space position controller

I. INTRODUCTION

Permanent magnet synchronous motors (PMSM) are more and more used in servo systems because of its high power density, large torque to inertia ratio and high efficiency. Generally mechanical position sensors are needed to measure precise rotor position and speed for high performance controls. But mechanical sensor with high accuracy is usually too expensive. Some control systems with low-precision position sensors have been proposed in [1] and [2] whose performances are limited. Usually measured rotor speed is obtained from the differential of measured position. If position sensor's accuracy is limited, the differential cannot be calculated every control period. Measured rotor speed usually contains a lot of noise. Some filters have been proposed to get off the noise with little phase lag, but these filters are too complex to be used in practice.^[3]

In motor control systems, design of speed regulator usually ignore the changes of load torque and suppose load is constant. So the variation of load torque may create some fluctuation on rotor speed. Then the information of load torque is usually needed to compensate the reference torque in order to decrease the speed fluctuation. As the torque sensor is too expensive, load torque observer is considered to be a good solution. Some state observers have been proposed in reference [4] and [5]. Observers based on Kalman filter are proposed in [6] and [7].

A new load torque observer based on Kalman filter is proposed in this paper. Kalman filter considers the influence of parameters errors and measurement noise, so Kalman filter is robust to parameters' errors, and can eliminate the noises and errors caused by quantized position sensor. The feedback gain matrix in Kalman filter is selected based on optimal control

theory, so it can make the observer both stable and convergent quickly.

Based on the observed rotor position, speed and load torque, a position control system based on a state space controller is proposed.^[8] It can achieve an excellent position control performance compared with traditional PID controller. The controlled rotor position can trace the reference very well and there is no overshoot in position control. The new controller contains no differential and is simple to use in practice. Some simulation and experiment results have been listed to verify the performance of the system.

II. OBSERVER BASED ON KALMAN FILTER

The movement equation of the PMSM is shown in (1).

$$\begin{bmatrix} \dot{\Omega} \\ \dot{\theta} \end{bmatrix} = \begin{bmatrix} -\frac{f}{J} & 0 \\ 1 & 0 \end{bmatrix} \begin{pmatrix} \Omega \\ \theta \end{pmatrix} + \begin{bmatrix} \frac{K_{em}}{J} \\ 0 \end{bmatrix} I_q + \begin{bmatrix} -\frac{1}{J} \\ 0 \end{bmatrix} T_L \quad (1)$$

Here Ω is mechanical angle speed, f is the coefficient of friction, J is inertia, T_{em} is electromagnetic torque, T_L is load torque, θ is mechanical rotor position. Load torque is considered to change very slowly compared with the rotor speed and position. That is to say:

$$\frac{dT_L}{dt} = 0 \quad (2)$$

Based on (1), with rotor speed, position and load torque as state variables and rotor position as output, a state observer based on Kalman filter can be formed.

$$\begin{aligned} \dot{\mathbf{x}} &= \mathbf{g}(x, u) + \mathbf{w} = \mathbf{F} \cdot \mathbf{x} + \mathbf{B} \cdot u + \mathbf{w} \\ \mathbf{y} &= \mathbf{C} \cdot \mathbf{x} + \mathbf{v} \end{aligned} \quad (3)$$

$$\mathbf{F} = \begin{bmatrix} -\frac{f}{J} & 0 & -\frac{1}{J} \\ 1 & 0 & 0 \\ 0 & 0 & 0 \end{bmatrix}, \mathbf{B} = \begin{bmatrix} p \cdot \Psi_d \\ 0 \\ 0 \end{bmatrix} \quad (4a)$$

$$\mathbf{C} = [0 \quad 1 \quad 0] \quad (4b)$$

$$\mathbf{x} = [\Omega \quad \theta \quad T_L]^T, u = I_q$$

Here p is poles pairs' number, Ψ_d is the flux on d axis in rotor flux oriented synchronous coordinate while I_q is q axis current. \mathbf{w} and \mathbf{v} are random disturbances. In fact \mathbf{w} is process noise which stands for the error of the parameters; \mathbf{v} is measurement

noise which stands for the errors in the measurement and sample.

The noise covariance matrixes are defined as follows:

$$\mathbf{Q} = \text{cov}(w) = E\{ww^T\} \quad (5.a)$$

$$\mathbf{R} = \text{cov}(v) = E\{vv^T\} \quad (5.b)$$

In practice, matrix \mathbf{Q} and \mathbf{R} are adjusted by experience because the statistical properties of noises are not known.

Kalman filter can be calculated by iteration as follows:

1. Compute the state ahead and the error covariance ahead.

$$\hat{x}_{k|k-1} = \hat{x}_{k-1|k-1} + g(\hat{x}_{k-1|k-1}, u_k) \cdot T_e \quad (6.a)$$

$$P_{k|k-1} = F_{k-1} P_{k-1|k-1} F_{k-1}^T + Q_{k-1} \quad (6.b)$$

2. Compute the Kalman gain.

$$K_k = P_{k|k-1} \cdot C^T \cdot (C \cdot P_{k|k-1} \cdot C^T + R_{k-1})^{-1} \quad (6.c)$$

3. Update estimate with measurement.

$$\hat{x}_{k|k} = \hat{x}_{k|k-1} + K_k (y_k - C \cdot \hat{x}_{k|k-1}) \quad (6.d)$$

4. Update the error covariance matrix.

$$P_{k|k} = [I - K_k \cdot C] \cdot P_{k|k-1} \quad (6.e)$$

Matrix P is error covariance of estimation.

$$P_{k|k} = E\{e_k^T \cdot e_k\} = \sum_{i=1}^n E\{[x_i - \hat{x}_i][x_i - \hat{x}_i]^T\} \quad (7)$$

$E\{\cdot\}$ is the computation of expectation value.

Generally the design of speed PI regulator is processed by supposing load torque as constant. If load torque is changing, the performance of speed PI regulator is limited. If the observed load torque is used to compensate the reference electromagnetic torque at the output of speed PI regulator, the limitation of the speed regulator can be eliminated.

The system proposed with Kalman filter is shown in Fig. 1 where the observed rotor speed, position are used instead of the values measured directly from position sensor, and the observed load torque is used as feed-forward compensation. Rotor flux oriented vector control system is used for high performance control of the PMSM. In rotor flux oriented synchronous coordinate (d-q axis), the d-axis current is controlled to be zero. Some simulations and experiments based on this system have been done.

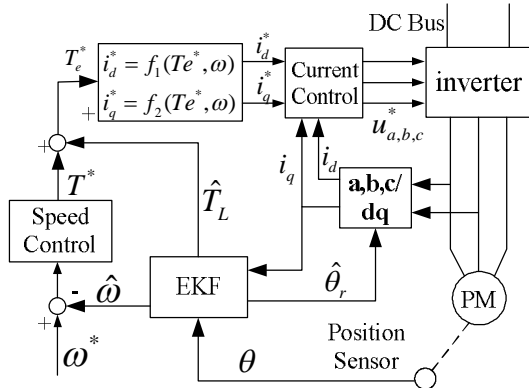

Fig. 1. Flow-chart of the system

III. SIMULATION RESULTS

To verify the performance of the observer, some simulations have been done using Matlab. The control frequency is 20 KHz. The parameters of the motor are shown in Table 1.

In Kalman filter, \mathbf{Q} and \mathbf{R} matrixes are set as follows:

$$\mathbf{Q} = \begin{bmatrix} Q1 & & \\ & Q2 & \\ & & Q3 \end{bmatrix} = \begin{bmatrix} 0.1 & & \\ & 0.1 & \\ & & 50.0 \end{bmatrix}, \mathbf{R} = [50.0]. \quad (8)$$

The initial values of matrix \mathbf{P} are set as:

$$P_{00} = \begin{bmatrix} 1.0 & & \\ & 1.0 & \\ & & 1.0 \end{bmatrix}. \quad (9)$$

The positions measured by position sensor directly and by Kalman filter are shown in Fig. 2. Compared with the real position, the position observed is more exact.

Since the accuracy of the sensor is very low, measured speed is calculate every 50 periods (1ms) using the traditional method (differential of the position), that is to calculate the rotor speed as (10). And this can cause some lag in speed.

$$\Omega = (\theta(k) - \theta(k-50)) / (50 \cdot T_e) \quad (10)$$

Measured speed is shown in first curve of Fig. 3, while the observed speed and the real speed are shown at the second and third curves. Speed obtained by the differential of the position contains a lot of noise and error, although a low-pass filter can be used to eliminate the noise, another lag will be caused.

TABLE I
PARAMETERS OF THE MOTOR

Parameters	Values
Stator inductance $L_d = L_q = L$	0.00125 H
Stator phase resistance R	0.155 Ohm
Rotor magnet flux ψ_r	0.153093 web
Inertia J	0.07 Kg · m ²
Coefficient of friction f	0.0826 N · m/(rad/s)
Number of pole pairs p	4
Points of position sensor par cycle	256 points

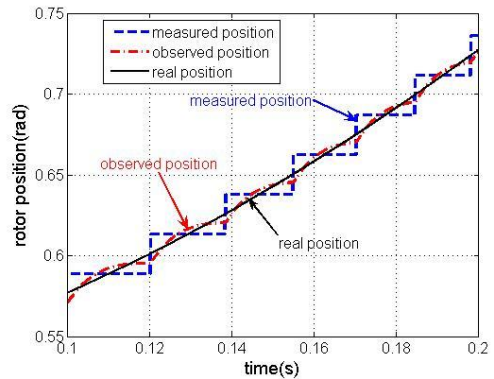

Fig.2. Measured, observed and real position

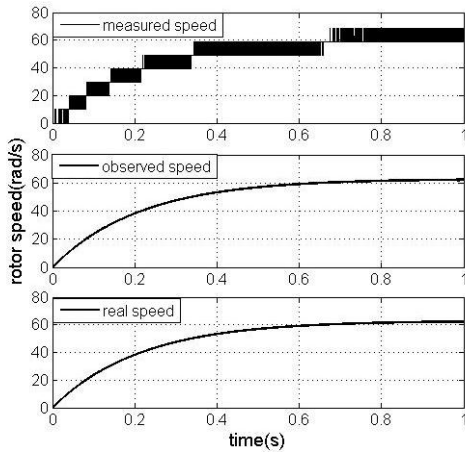

Fig.3. Measured observed and real speed

During load torque impact, load torque observed by Kalman filter and the real load torque are shown in Fig. 4.

When there are some errors in the coefficient of friction, the part of the friction torque caused by the parameter error will be included in observed load torque. Fig. 5 shows the observed load torque when the friction coefficient used in Kalman filter observer is only 50% of the real one.

When the inertia parameter is 50% of the actual one, the observed load torque is shown in Fig.6. It can be seen that the error of the inertia parameter makes the observed load torque contain some errors in dynamic process, but in steady time, the observed load torque agrees with the real one very well. This tests the robust characters of the observer.

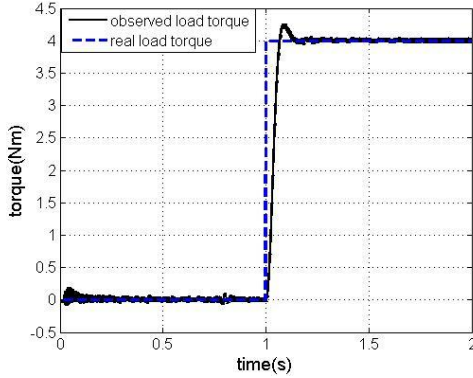

Fig.4. Observed and real load torque

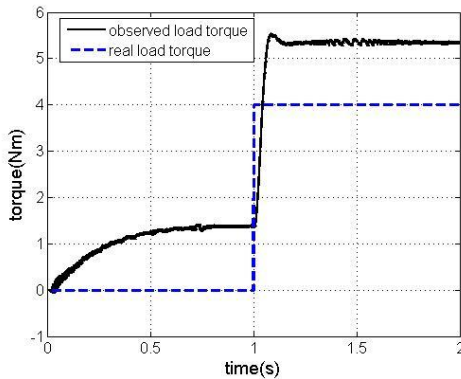

Fig.5. Observed load torque when friction coefficient is 50% of the actual value

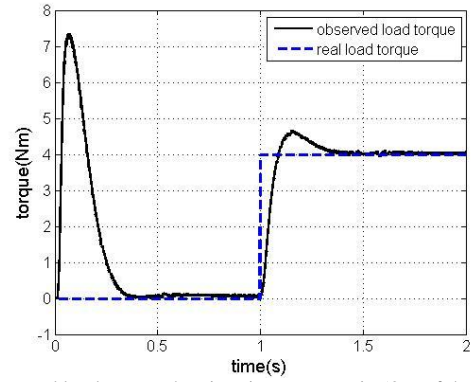
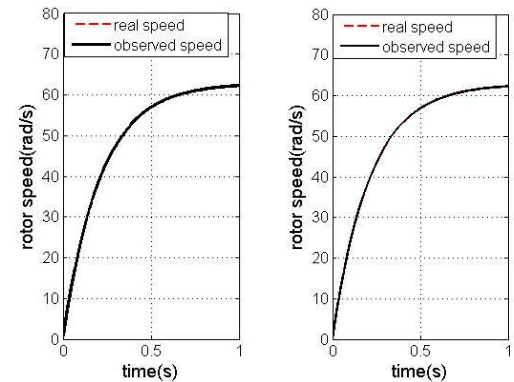

Fig.6. Observed load torque when inertia parameter is 50% of the actual value

Since the statistical properties of the noises are unknown, the precise noise covariance cannot be known. So matrix Q and R can only be adjusted by experiences. Generally matrix Q describes the statistical model properties of the system. Increment of the matrix Q can increase the feedback gain K and increase the response of the observer. And the confidences of the system parameters are decreased. Matrix R describes the noises in measurement. So increment of matrix R can decrease the confidence of measured value and decrease the response of the system.^[9]

Speed and load torque observe results with different Q and R matrix are shown in Fig. 7, Fig. 8, Fig. 9 and Fig. 10. It can be seen that the variation of matrix Q has little effect on speed observation but affects the convergence speed of load torque.



(a) Q_1 is 0.0001 (b) Q_1 is 10000
Fig. 7. Speed observe results with different sets of matrix Q

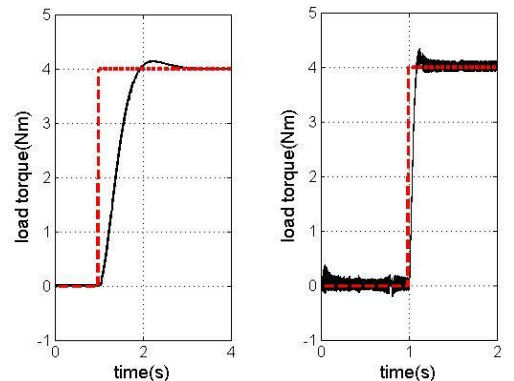

(a) Q_3 is 0.1 (b) Q_3 is 1000
Fig. 8. Load observe results with different sets of matrix Q

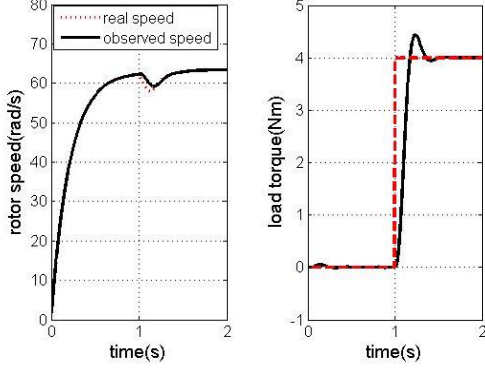

Fig. 9. Observed speed and torque when matrix R is 50000

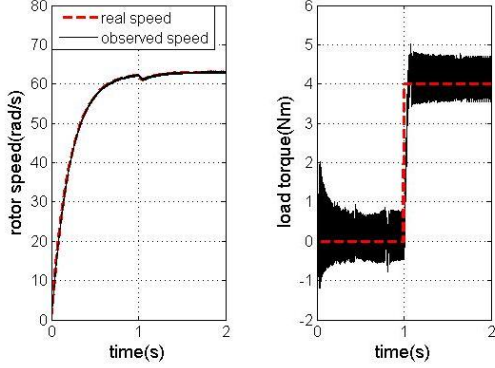

Fig. 10. Observed speed and torque when matrix R is 0.05

It can be seen that when matrix R is larger, the confidences of measured position is lower, which will cause some errors in observed speed during quick dynamic process. When R is smaller, the discrete errors in measured position will have effects in observed load torque.

In simulation, due to the position measurement, the observed position can trace the measured position well during the variation of matrix Q and R. It can also be seen that the Kalman filter proposed in this paper is very robust to the parameters of matrixes Q and R. The system can keep stable in spite of the large variations of matrix Q and R.

In practice, the initial states of the system are usually unknown, so the initial values of matrix P cannot be unknown in advance. The initial values of matrix P can only influence the start-up characteristic and has no effects to steady states.

IV. EXPERIMENTAL RESULTS

Some experiments have been done on the platform with the DSP TMS320C6711 as the controller. The parameters of the motor are shown in Table 1. In fact, the real inertia and friction coefficient parameters are not known precisely. Parameters in TABLE 1 are just rough estimations.

The Q and R matrixes are set as follows:

$$Q = \begin{bmatrix} 1.0 & & \\ & 1.0 & \\ & & 10.0 \end{bmatrix} \quad (11a)$$

$$R = [50.0] \quad (11b)$$

The initial values of matrix P is set as.

$$P_{00} = \begin{bmatrix} 1.0 & & \\ & 1.0 & \\ & & 1.0 \end{bmatrix} \quad (12)$$

The observed speed and load torque are shown in Fig. 11 and Fig. 12. The observed load torque has a very good dynamic response speed and steady state precision.

Under the same load torque impacts, speed responses in systems with and without compensations of the observed load torque are shown in Fig.13 and Fig. 14. It can be seen that the compensation can greatly eliminate speed fluctuation during load impact and can greatly improve the speed response speed.

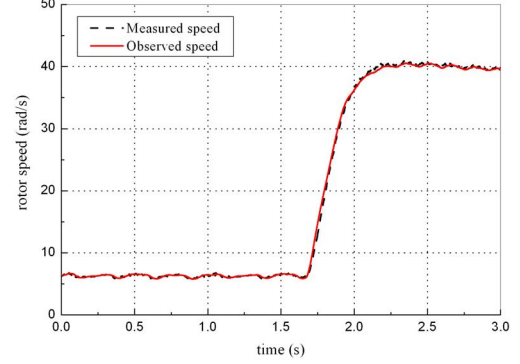

Fig. 11. Observed rotor speed

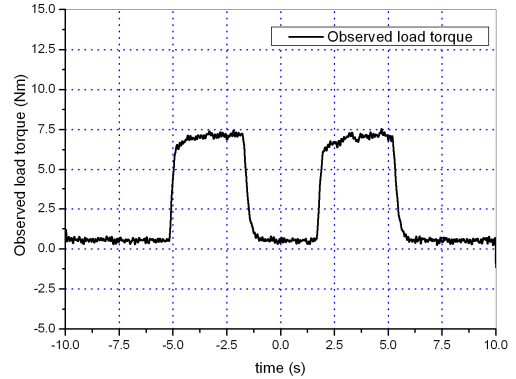

Fig. 12. Observed load torque

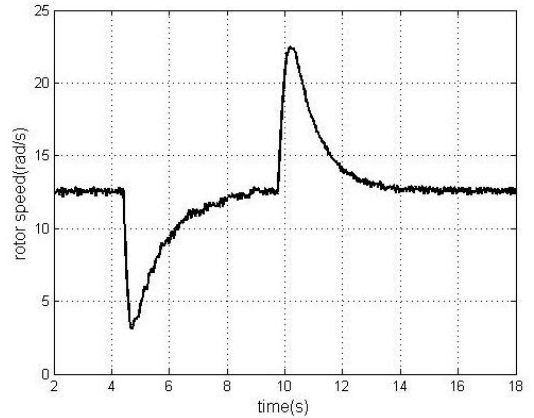

Fig.13. Speed response without compensation

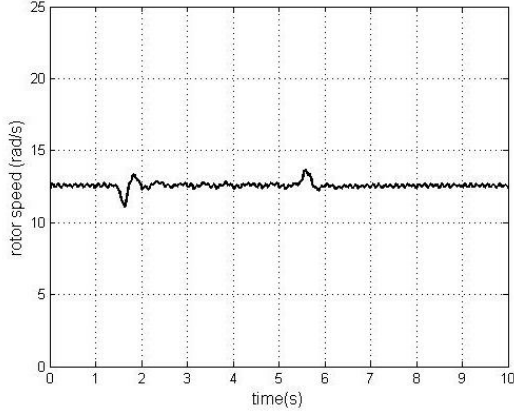

Fig. 14. Speed response with compensation

V. POSITION CONTROL SYSTEM

To get a better position control performance, a new state space position controller is adopted which is shown in Fig.15. The observed rotor speed, position, load torque and reference position are used as state variables. The torque current reference can be obtained directly at the output of the controller. In this controller, the integration can eliminate the position control errors. The observed rotor position and speed are used as feedbacks by coefficients K_{s1} and K_{s2} . Position reference is used as feed-forward by coefficient K_θ . Observed load torque is used as feed-forward compensation by K_v .

$$I_q^*(k) = -K_{s1}\Omega(k) - K_{s2}\theta(k) + K_r X_r(k) + K_\theta \theta_{ref}(k) + K_v \hat{T}_L(k) \quad (13)$$

The values of the five coefficients can be obtained by the expectation of the root locus and the purpose to eliminate the effect of the load torque.^[8]

The discrete form of (1) can be written as:

$$\begin{bmatrix} \Omega(k+1) \\ \theta(k+1) \end{bmatrix} = \mathbf{F}_m \begin{bmatrix} \Omega(k) \\ \theta(k) \end{bmatrix} + \mathbf{H}_m I_q(k) + \mathbf{H}_v T_L(k)$$

Here:

$$\mathbf{F}_m = e^{A \cdot T_c} \begin{bmatrix} \lambda & 0 \\ \frac{J}{f}(1-\lambda) & 1 \end{bmatrix} \begin{bmatrix} F_{m11} & 0 \\ F_{m21} & 1 \end{bmatrix}$$

$$\mathbf{H}_m = \begin{bmatrix} \frac{K_{em}}{J}(1-\lambda) \\ \frac{K_{em}}{J} \left(T_c - \frac{J}{f}(1-\lambda) \right) \end{bmatrix} = \begin{bmatrix} H_{m1} \\ H_{m2} \end{bmatrix}$$

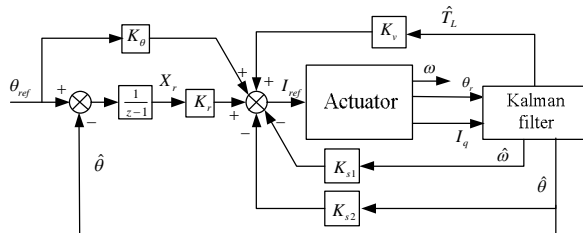

Fig. 15. State space controller

$$\mathbf{H}_v = \begin{bmatrix} \frac{-1}{f}(1-\lambda) \\ \frac{-1}{f} \left(T_c - \frac{J}{f}(1-\lambda) \right) \end{bmatrix} = \begin{bmatrix} H_{v1} \\ H_{v2} \end{bmatrix}$$

$$\text{With: } \lambda = \exp\left(-\frac{f}{J}T_c\right).$$

If considering the output of the integration X_r as a variable, the state equation can be written as:

$$\begin{bmatrix} \Omega(k+1) \\ \theta(k+1) \\ X_r(k+1) \end{bmatrix} = \mathbf{F}_{bf} \begin{bmatrix} \Omega(k) \\ \theta(k) \\ X_r(k) \end{bmatrix} + \begin{bmatrix} H_{m1}K_\theta \\ H_{m2}K_\theta \\ 1 \end{bmatrix} \theta_{ref}(k) + \begin{bmatrix} H_{v1} \\ H_{v2} \\ 0 \end{bmatrix} T_L(k) + \begin{bmatrix} H_{m1}K_v \\ H_{m2}K_v \\ 0 \end{bmatrix} \hat{T}_L(k). \quad (21)$$

The system's dynamic matrix is:

$$\mathbf{F}_{bf} = \begin{bmatrix} F_{m11} - H_{m1}K_{s1} & -H_{m1}K_{s2} & H_{m1}K_r \\ F_{m21} - H_{m2}K_{s1} & 1 - H_{m2}K_{s2} & H_{m2}K_r \\ 0 & -1 & 1 \end{bmatrix}.$$

If the expected poles are $(z - p_{bf})^3$ with $p_{bf} = \exp(-T_c \omega_{bf})$, then we can obtain:

$$K_r = \frac{(1 - p_{bf})^2}{F_{m21}H_{m1} - F_{m11}H_{m2} + H_{m2}}. \quad (23a)$$

$$K_{s1} = \frac{H_{m2} \left(F_{m11} - p_{bf}^3 + l \left(\frac{2 + F_{m11} - 3p_{bf} - K_r}{H_{m2}} \right) \right)}{H_{m1}(l + H_{m2})}. \quad (23b)$$

$$K_{s2} = \frac{2 + F_{m11} - 3p_{bf} - H_{m1}K_{s1}}{H_{m2}}.$$

$$\text{With: } l = F_{m21}H_{m1} - F_{m11}H_{m2}$$

Suppose that the observed load torque is the same as the real one, if the effects of load torque are expected to be compensated at all, that is to say the sum of the last two items of (21) is expected to be zero. Then there is:

$$K_v = \frac{1}{K_{em}} - \frac{H_{v1}}{H_{m1}} - \frac{H_{v2}}{H_{m2}}$$

The transform equation from the position reference to rotor position is:

$$\frac{\theta(z)}{\theta_{ref}(z)} = \frac{K_\theta (z-1 + \frac{K_r}{K_\theta})(H_{m2}z + l)}{\det[z\mathbf{I} - \mathbf{F}_{bf}]}$$

A pole of the system can be compensated by K_θ in order to reduce the orders of the system and improve the dynamic response speed. That is desired:

$$K_\theta = \frac{K_r}{1 - p_{bf}}$$

In the experiment, the parameters of the state space controller are as follows:

$K_v=1.633$, $K_r=0.0144$, $K_{s1}=1.58$, $K_{s2}=8.62$, $K_\theta=2.8754$;

Using the state space position controller, there is a load torque impact at about 40s, the position control performance is shown in Fig. 16. It can be seen that the position can trace the reference position very well and there is no overshoot. Corresponding rotor speed is shown in Fig.17. The observed load torque during load torque impact is shown in Fig. 18. The direction of the load torque is determined by the directions of speed and acceleration of the motor. The effects of load torque changes are compensated at all. It is proved that the proposed state controller is very suitable for servo systems.

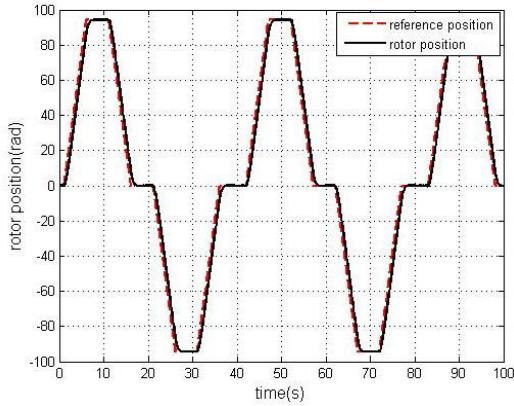

Fig. 16. Rotor position control performance

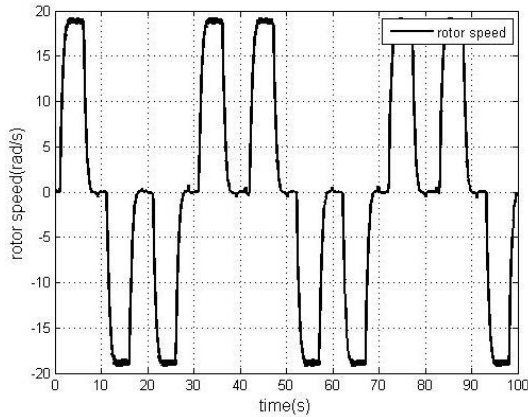

Fig. 17 Rotor speed during position control

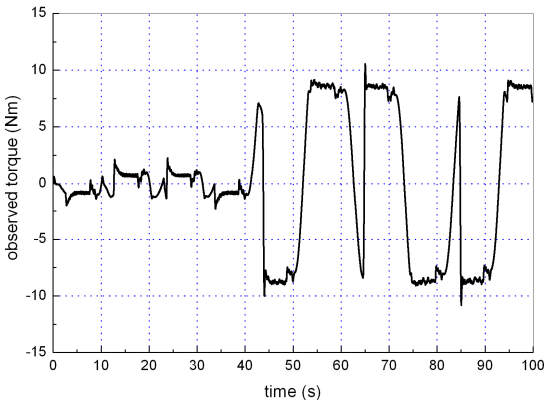

Fig. 18. Observed load torque during position control

VI. CONCLUSION

A load torque observer based on Kalman filter is proposed in this paper. The observer can observe the precise rotor position, rotor speed and load torque with only very low accuracy position sensor. It can greatly decrease the cost of the servo systems. Based on the observed values, a state space position controller is formed where the rotor position, speed, load torque and position references are used as the state variables. The state controller reduces the complex of the servo systems and can obtain a very excellent position control performance compared with the traditional PID controller.

This approach is effective, but the major difficulty concerns the choices of the Q and R parameters that must be driven on the experimental platform after some online tests. Unfortunately we don't know any methods general to solve this difficulty.

REFERENCES

- [1] Todd D. Batzel, and Kwang Y. Lee, "Commutation Torque Ripple Minimization for Permanent Magnet Synchronous Machines with Hall Effect Position Feedback", *IEEE Trans. Energy Conversion*, vol. 13, No.3, pp. 257-261, Sept. 1998.
- [2] Shigeo Morimoto, Masayuki Sanada and Yoji Takeda, "High-performance current drive for PMSM and SynRM with only low-resolution position sensor", *IEEE Trans. Industry Applications*, vol. 39, No. 3, pp. 792-801, May/June 2003.
- [3] Seppo J. Ovaska, "Improving the velocity sensing resolution of pulse encoders by FIR prediction," *IEEE Trans. Instrum. Meas.*, vol. 40. No. 3, pp657-658, June 1991.
- [4] Robert D. Lorenz, and Keith W. Van Patten, "High resolution velocity estimation for all-digital, ac servo drives," *IEEE Trans. Industry Applications.*, vol. 27, No. 4, pp701-705, July/August 1991.
- [5] Guchuan Zhu, Lousi-A. Dessaint, Ouassima Akhrif, and Azeddine Kaddouri, "Speed Tracking Control of a Permanent-magnet Synchronous Motor with State and Load Torque Observer," *IEEE Trans. Industry. Electronics.*, vol. 47, No. 2, pp346-355, April. 2000.
- [6] Taeg-Joon Kweon, and Dong-Seok Hyun, "High-performance speed control of electric machine using low-precision shaft encoder", *IEEE Trans. Power Electronics*, vol. 14, pp. 838-849, Sept. 1999.
- [7] Xu Dianguo, Wang Hong, and Shi Jingzhuo, "PMSM servo system with speed and torque observer", *in proc. PESC '03*, vol.1, pp. 241 – 245, June 2003.
- [8] Maurice Fadel, "Position control laws for electromechanical actuator", *in proc. ICEMS '05*, Sep. 2005.
- [9] Silverio Bolognani, Luca Tubiana, and Mauro Zigliotto, "Extended Kalman filter tuning in sensorless PMSM drives", *IEEE Trans. Industry Applications*, vol. 39, NO. 6, pp. 276-281. Nov./Dec. 2003.