



**HAL**  
open science

## POST simulation softwares

Bruno Dagues, Maurice Fadel, Xavier Roboam, Philippe Azema

► **To cite this version:**

Bruno Dagues, Maurice Fadel, Xavier Roboam, Philippe Azema. POST simulation softwares: study and teaching of numerical control of static converter-electrical machine assemblies. 6th European Conference on Power Electronics and Applications, Sep 1995, Séville, Spain. 6 p. hal-03537328

**HAL Id: hal-03537328**

**<https://ut3-toulouseinp.hal.science/hal-03537328>**

Submitted on 20 Jan 2022

**HAL** is a multi-disciplinary open access archive for the deposit and dissemination of scientific research documents, whether they are published or not. The documents may come from teaching and research institutions in France or abroad, or from public or private research centers.

L'archive ouverte pluridisciplinaire **HAL**, est destinée au dépôt et à la diffusion de documents scientifiques de niveau recherche, publiés ou non, émanant des établissements d'enseignement et de recherche français ou étrangers, des laboratoires publics ou privés.

## POST SIMULATION SOFTWARE : STUDY AND TEACHING OF DIGITAL CONTROL OF STATIC CONVERTER / ELECTRICAL MACHINE ASSEMBLIES.

B. Dagues, M. Fadel, X. Roboam, P. Azéma.

Laboratoire d' Electrotechnique et d'Electronique Industrielle  
URA CNRS n°847 ENSEEIHT INP Toulouse (France)

**Abstract** : This paper proposes the presentation of a simulation software package. This software simulates a system including static converters, electrical machines, and digital control in order to study and design control laws.

First, the principles on which rely those software will be presented. Then examples will be given to underline their qualities as tools for design help and physics phenomena understanding. Considering the specifications of the torque control of a permanent magnet synchronous drive, phenomena linked to the physical process and to the control implementation will be studied. (dead times, delays, sampling effects, quantization, ...)

**Keywords** : Simulation software, control laws study tools, converter-electrical machine assemblies, synchronous machine, simulated experimentation.

Control law strategies applied to static converters-electrical machines assemblies become increasingly complex, due in particular to electronic components evolution. This complexity follows the evolution of industrial needs. The more and more constraining specifications lead to the utilisation of Automatic and Signal Processing modern tools.

Considering the disparity of knowledge areas approached for the piloting of an electrotechnical process, designers of controls laws faces numerous branches of learning. Indeed, they must access to accurate data concerning the whole system, including :

- the machine and its modelling, disturbed by phenomena such as saturation, skin effects and thermal variations.
- the static converter and its specific constraints (delays, dead times, switching losses, filters, non-linearity, ...)
- the control unit, involving quantization, sampling and input/output data processing accuracy (noise measurement ...). Regarding all those remarks, it seems utopian to implement electrical machines control laws, using a direct experimentation method. Thus, digital simulation has become a prime importance step for the control unit design. Having this in mind, a simulation methodology called SOSIE (Simulation Organisée des Systèmes Interconnectés Electriques) has been developed [1][2]. From this methodology was born a family of simulation software :
  - POSTMAC (Programme Ouvert de Simulation pour le Test et l'étude d'une Machine Asynchrone Commandée) dedicated to the induction machine control [3],
  - POSTMSYNC for the synchronous machine control,
  - POSTMCC for the DC machine control.

These software were especially studied to design, test and compare control laws.

Their first originality is that the software part corresponding to the control is entirely user-programmable (user-defined control). A choice of entirely pre-programmed modules is proposed to simulate supply and electrical machine. All parameters of these modules can be initialised.

These software are quickly accessible for control design specialists with no needs to be an expert in the fields of the other parts of the system (supply, machine,...). Thereby, it allows an efficient and rapid test of control laws designed from modern control technics.

The progressive approach is the second important characteristic of the POST software family. Indeed, the user is enabled to progress step by step, towards more and more accurate simulation results, starting with an idealised process and tuning the model of each part of the system. During an initial phase of study with an idealised process, the progressive approach allows to simplify and clarify problems. Furthermore, users, by limiting broadly the simulation time (large calculation increment used) can rapidly progress in designing and validating their control law. It is mainly on this point that the POST software are innovating.

Frequently, a constituent of the assembly is privileged : supply (static converter simulation) [5] or electrical machine [6] (simulation by means of fields calculation).

This type of tool proposes a very accurate simulation of the element on which the stress is put. This approach has an indisputable interest, because of the accuracy of the results and the possibility of zooming a very particular point of the simulated system, but it often needs a precise knowledge of the element. Moreover it generates important calculation times as soon as the beginning of the study, which is often prohibitive for a complete simulation of the electromechanical functioning of the whole Converter Machine Control assembly. Thus, both software families appear perfectly complementary.

This paper proposes to illustrate the efficiency of the POST software tools for the design, the test and the study of control law strategies. All the design phases of the control code will be described, step by step. After a description of its algorithmic and electrotechnical structure, the software will be presented as a design and test tool.

In order to illustrate software characteristics, a torque control of a permanent magnet synchronous drive application will be presented. The possibility of progressive design will be shown off.

This POST software approach allows to access quickly to a good comprehension of the process phenomena. It provides efficiency and robustness to the control laws.

Finally, it obviously facilitates global understanding of the system behaviour, which confers "education tool label" to POST software.

# 1 POST SIMULATION SOFTWARE

Post software (including POSTMAC, POSTMSYNC, POSTMCC) allow a user to simulate static converters - electrical machine - control assemblies. These software, specifically designed for the analysis of control laws, follow the rules and principles of the SOSIE methodology. This article part firstly describes the architecture of these software, and secondly specifies the electrotechnical point of view.

## 1.1 POST software architecture

The software is divided into two modules. The first one concerns the process while the second concerns the control (see figure 1.1).

Because the mathematical models are already implemented, the first part is totally flexible. That is, the user can select the model he wishes to run among a library of pre-defined models. The parameters associated with the selected mathematical model may then be specified. This part of the software also includes the time management, the control of each module state and the writing of the results in a file.

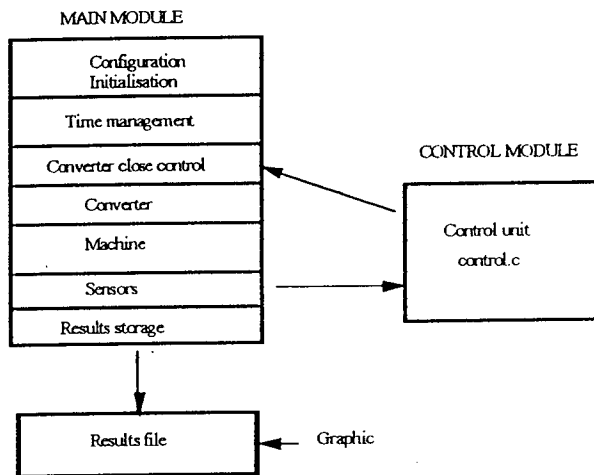

Figure 1.1: Software structure.

The control module of the software corresponds to a file specified in the C language and following a pre-defined format. This file allows the user to specify its own control laws which would then communicate with the other modules via its input/output. Figure 1.2 displays an example of the C file specifying the control commands (which are given to the operational module).

```

/* user's variables declaration */
float error, reference_current;
...
/* initialisation */
static int Simul_init()
{
error = 0.; reference_current = 7.7;
...
}
/* control calculation */
static int calcul()
{
error = reference_current - sensor_current;
...
control_value = ...
}
    
```

Figure 1.2: Control unit structure

The user builds the control algorithm using the parameters given by the sensors. These parameters include power supply voltage, current, speed, position and should be specified in accordance with the selected operational module.

Communication between the POSTxxx software and the control file (entitled Control.c) is governed via input/output global variables. Standard compilation and linking establish the communication link.

These software are user-friendly for the set-up of the control algorithm and for the selection and execution of a simulation. They use tools such as multi-windows, and pop-down menus which facilitate their usage

## 1.2 Electrotechnical assembly bloc diagram

Figure 1.3 shows the diagram of the system (engineer view point).

For developing and building the control algorithm, the user has various power supply type, various modes for the machine and two types of sensors (perfect or real sensors)[3]. Those models and parameters allow to validate the basic principle of the studied control law strategy with at the beginning, ideal world models (for example, ideal voltage inverter, perfect sensors, analogic control ...).

Then, step by step, the user can integrate more and more complex models to simulate reality. It can then analyse the impact of each additional constraint he specifies.

This structure allows a user, for example to study the impact of non-linearity on a voltage inverter controlled in PWM. The user can also analyse the degradation linked to the sensors... Finally, it can also allow the user to analyse the consequences of the sampling.

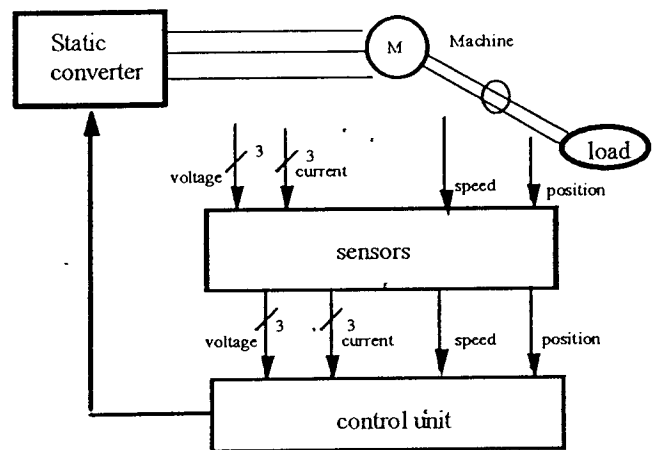

Figure 1.3: Simulated system.

## 2 TORQUE CONTROL STUDY OF A PERMANENT MAGNET SYNCHRONOUS MACHINE WITH SALIENT POLES

The advantage of using a permanent magnet synchronous machine as an actuator doesn't need to be proved; the performances achieved are attractive and it is easy to implement. Ways of control are numerous and a large number of choices are to be specified as well for the power supply structure as for the control strategy. In this work, we will study different control configurations for torque control specifications, with the help of the POSTM5 software. The reached performances will be compared taking into account the largest number of phenomena linked to the operation of this type of plant.

## 2.1 Studied device presentation

The current control into a synchronous machine is compulsory to control the torque. With the set value of the R.M.S. phase current  $I_{ref}$  and the load angle  $\psi$ , one can set the currents by two different ways :

- either on the a,b,c axis, by setting the phase currents independently.
- or on the d,q axis, by setting the equivalent two-phase currents.

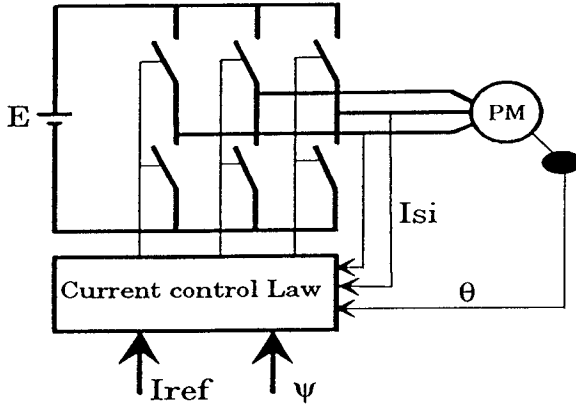

Figure 2.1

On the other hand, the inverter control can be realised either using a hysteretic control, or a PWM control law.

The PWM control law may be implemented with analogic or discrete regulators. This allows different combinations which generate specific characteristics. It is precisely what we propose to study hereafter.

## 2.2 Simulation software POSTM5 : waveform study

During the conception step of a Converter - Machine association it exists a purely electrotechnical part of work where POSTM5 is very helpful : it is the waveform study.

In facts the setting of the R.M.S. current in the electrical machine can be achieved different ways, generating very different waveforms.

### 2.2.1 Current setting with hysteretic regulators

In order to obtain a torque of high quality the control must generate currents as sinusoidal as possible. The use of hysteretic regulators is a solution frequently chosen, notably for the low and medium power machines.

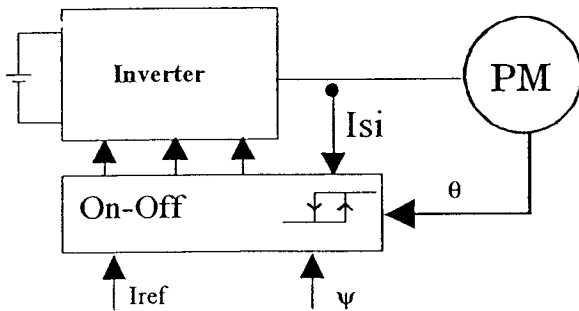

Figure 2.2

$$I_{sref1} = I_{ref} * \sqrt{2} * \sin(\theta + \psi)$$

$$I_{sref2} = I_{ref} * \sqrt{2} * \sin(\theta + \psi - 2 * \pi / 3)$$

$$I_{sref3} = I_{ref} * \sqrt{2} * \sin(\theta + \psi - 4 * \pi / 3)$$

The figure 2.3 thereunder shows the current absorbed by a machine fed according to this principle. The current follows the reference within an acceptable error. The current is not far from being in-phase with its reference and its residual ripple is under control. But consequently the switching frequency evolves along the reference. The frequency becomes maximum on a band which is mainly dependent of the set value of the load angle; i.e. the phase between the e.m.f. and the voltage source. See figure 2.4 resulting torque, with the load angle kept equal to zero.

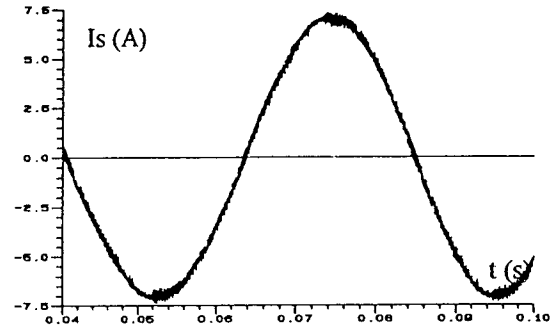

Figure 2.3

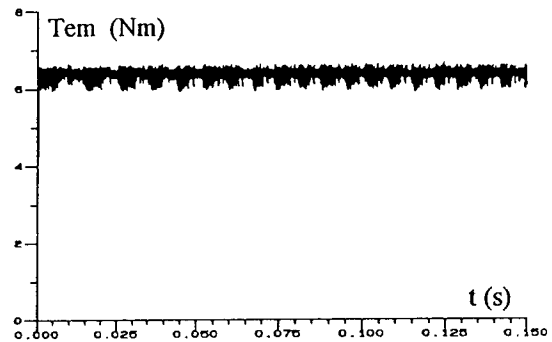

Figure 2.4

### 2.2.2 Currents setting with PWM control

Another way in order to obtain high quality torque is to use a constant frequency control with a variable duty cycle, it is the PWM control. There is a lot of strategies of that kind, based on an analogic  $R(s)$  or discrete  $R(z)$  regulator generating reference voltage (see figure 2.5). It then allows to determinate the state of the different inverter switches.

POSTM5 software proposes 5 PWM strategies :

- classical PWM
- regular symmetrical or asymmetrical PWM
- three phases symmetrical or asymmetrical PWM

The first three are calculated with three independent phases whereas the others are built considering a three phases load.

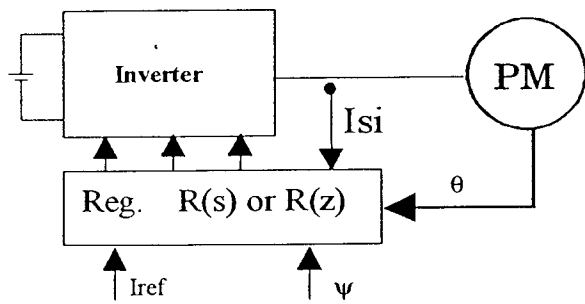

Figure 2.5

$R(s)$  : three analogic regulators

$R(s) = K_p + K_i / s$

$R(z) = (r_0 * z + r_1) / (z - 1)$

Whatever is the chosen strategy, the regulator is important for the dynamic performances of the assembly : it creates a phase displacement between the reference current and the real current inside the winding. This phenomenon is shown on figure 2.6. This figure has been obtained using synchronous machine with salient poles fed with a classical PWM, with an analogic regulator calculated to obtain a pass-band for the current loop, a decade below switching frequency, i.e. 1000 Hz.

We can note that the phase displacement is not equal to zero and that the current is less than compared to its reference. Moreover the residual ripple is variable as the switching frequency is constant.

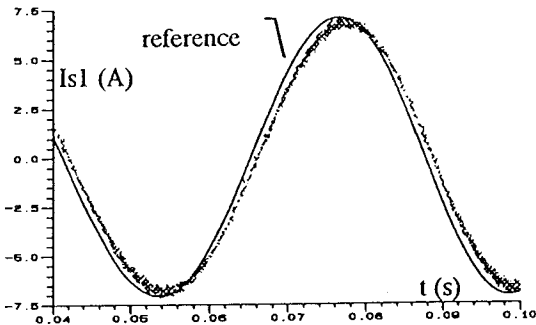

Figure 2.6

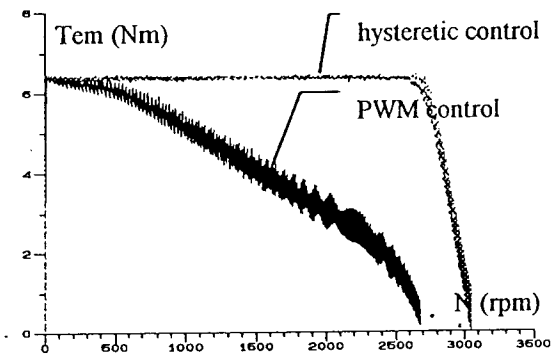

Figure 2.7

On the torque vs. current plane figure 2.7, obtained with an unloaded starting of the motor, we can note that the performances are not as good as those obtained with a hysteretic control law. Choosing a three phases PWM control strategy allows greater RMS voltage and attenuate the effect described above. It is also possible to place a regulator to insure the e.m.f. compensation in order to increase the performances of the current loop (figure 2.8).

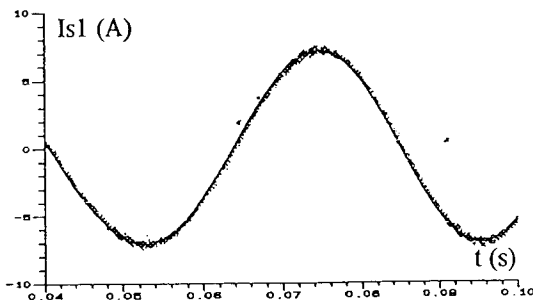

Figure 2.8

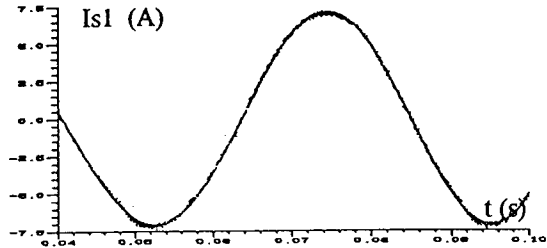

Figure 2.9

When using a numerical law, the regulators  $R(z)$  must be calculated precisely not to alter the desired performances. The use of a pole placement method which allow to get a first order system, permit to define particularly efficient discrete regulators. The absorbed current is shown on figure 2.9.

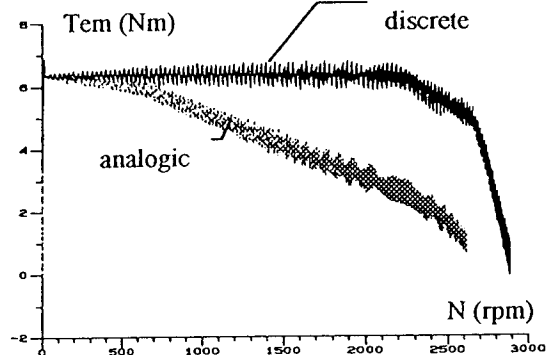

Figure 2.10

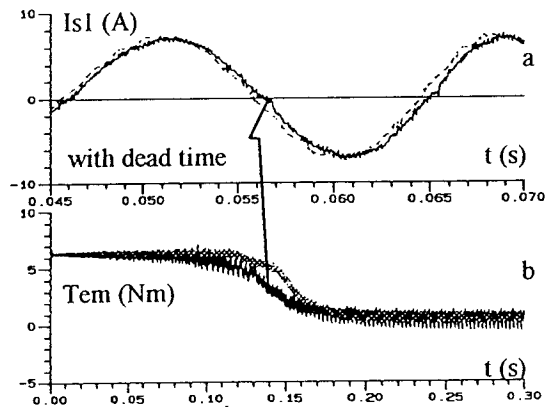

Figure 2.11

On the torque vs. speed plane, the performances are better than with analogic regulators (figure 2.10).

Moreover with the help of the POSTM5 software, we can study the influence of stress inherent in the voltage inverter, for example influence of the dead time. Figure 2.11 shows that for the same reference current, the obtained torque is lower (b), and the current distortion ratio is greater (a).

### 2.3 Analysis of various control strategies using the POSTM5 software

In order to insure a better use of the voltage source inverter, one can set up various strategies for controlling the static converter. Among these control methods, we will analyse a strategy allowing to control the currents in the reference frame with axis linked to the rotor. Figure 2.12 outlines the basic principles of a two phases control.

As shown on figure 2.12, there are 3-2-phases and 2-3-phases transformation parts. Only two regulators are necessary, furthermore, these regulators can act on continuous quantities.

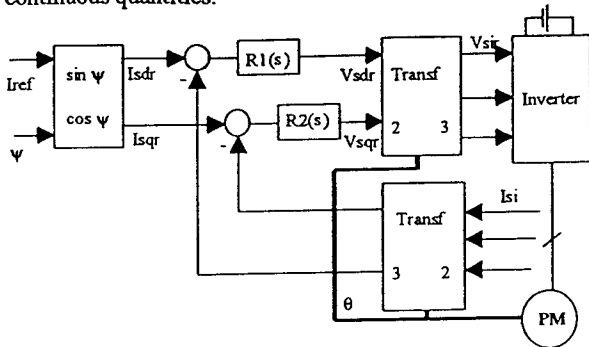

Figure 2.12

The behaviour of a synchronous machine with a two phases control is shown hereafter. Because of the machine with salient poles, R1(s) and R2(s) are different. Here we have chosen P.I. regulators.

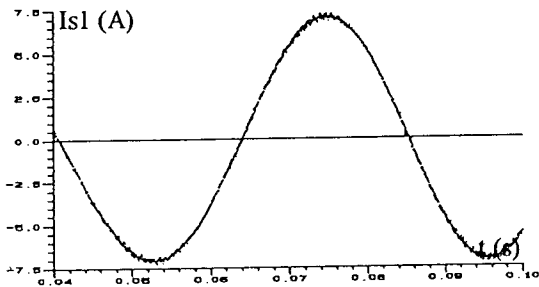

Figure 2.13

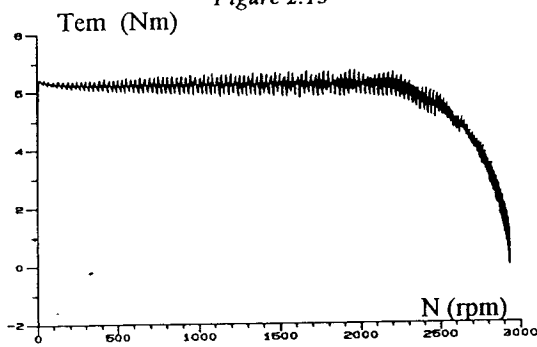

Figure 2.14

Figure 2.13 shows the phase 1 current and its reference. As shown in the figure 2.14, this strategy allows the actuator to be more efficient in the torque vs. speed plane in regard to the three-phases control (figure 2.7).

Lastly, the torque of the synchronous machine depends heavily on the load angle. The angle can then be used to control the stator-rotor inductive coupling. It can either optimise the motor operation by giving a maximum torque for a specific current, or optimise the inverter action by imposing a unit power factor.

It can be shown that, for a permanent magnet synchronous machine with salient poles, the torque is maximum if the relation (1) is validated and if the relation (2) creates a unit power factor operating.

$$(1) \quad \psi = \arcsin \left( \frac{\Phi - \sqrt{\Phi^2 + 8 * I_{ref}^2 * (L_{sd} - L_{sq})^2}}{4 * (L_{sd} - L_{sq}) I_{ref}} \right)$$

$$(2) \quad \psi = \arcsin \left( \frac{\Phi - \sqrt{\Phi^2 - 4 * I_{ref}^2 * L_{sq} * (L_{sd} - L_{sq})}}{2 * (L_{sd} - L_{sq}) I_{ref}} \right)$$

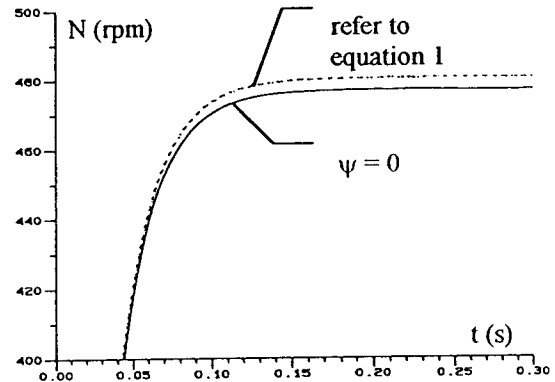

Figure 2.15

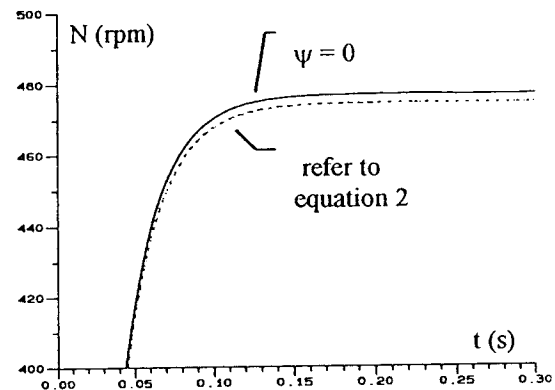

Figure 2.16

Figures 2.15 and 2.16 show the impact on speed of these strategies with a constant reference current of 5 Amp. The choice of one strategy or the other is to be done according the aim of the control-law and specifications.

#### 2.4 POSTM5 software for studying constraints associated with the implementation of a numeric control-law

The numeric specification of algorithms is a problem which importance grows with desired performances. This stage of the specification is generally considered at the end of the work. It is then up to the experimenter to make choices, these are too often arbitrary and lead to degradation of the final performances or in some cases to a complete review of the specification 'process. However, performance and accuracy can now be studied using simulation. It is more and more easy and useful to be helped by the computer tool.

Among the criteria which can decrease the quality of a control-law (e.g. calculation delay, data conversion ...) the next section focuses on the impact of the sensors accuracy on the performances of the actuator. This study is conducted by modifying the bits number which represent the value of a sensor output (e.g. speed, position..).

### 2.4.1 Effect of quantization

The analogic to digital conversion done by the sensors has to be taken into account when implementing control-law. The control law needs the capture of the currents as well as speed and position. The data conversion creates an error linked to the value of the least significant bit. This can alter the regulation, sometimes to the point of generating instability.

#### Digitalized currents.

The more the currents are controlled the more the torque is smooth, that is its quality is good. But the digital conversion of the data can alter the accuracy of the current measurement and as a consequence the torque quality and thereby the performances of the complete electrical drive. Figure 2.17 shows torque ripples generated when the current is encoded on 8 bits. This creates speed ripples (see figure 2.18).

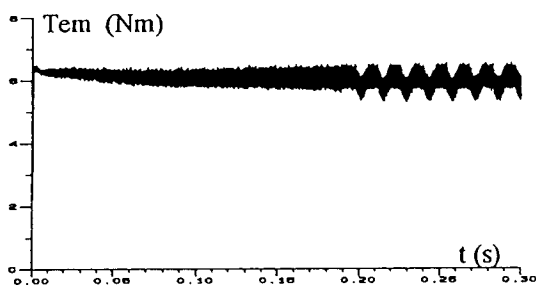

Figure 2.17

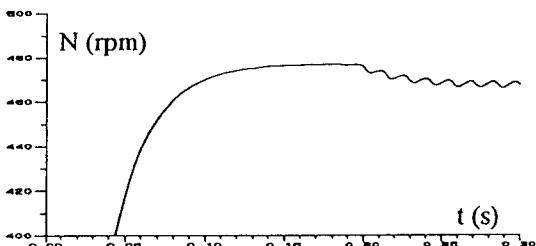

Figure 2.18

### 2.4.2 Calculation delay impact

Each mathematical operation takes the CPU some clock cycles. When the control law algorithm is getting complex the calculation delay grows. This may delay the control orders and by the way generate torque oscillations. Figure 2.19 shows the current when the control delay value has reached one sampling period (100 $\mu$ s).

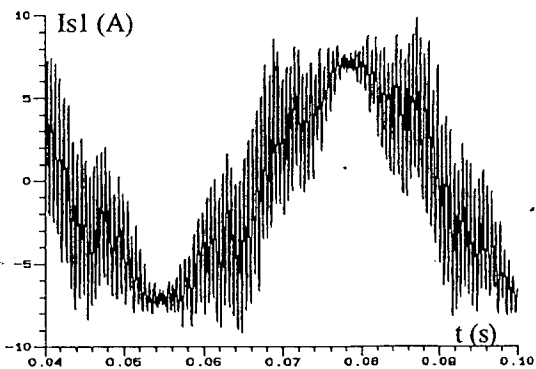

Figure 2.19

## 3 CONCLUSION

The use of a static converter for the control of an electrical machine has shown the various effects generated by adjusting discrete components in order to control continuous quantities.

Moreover the interactions inherent in a converter-machine-control assembly generate numerous and complex phenomena which one must take into account during the conception step.

This amply justifies using the help given by simulation software like the POSTM5 package. We have shown in this work that such a tool allow to study in turn electrical aspect, control aspect, and numerical aspect. In each case one may combine as he wishes the different constraints.

## REFERENCES LIST

- [1] M. GRANDPIERRE  
"Commande numérique de machines à commutation électronique. Automates de commande rapprochée (A.C.R.). Méthode de simulation numérique (S.O.S.I.E.)"  
Thèse d'état, INP Toulouse, 1987.
- [2] X. ROBOAM, B. DAGUES, JC HAPIOT, J. FAUCHER  
"Elaboration of a simulation software by the SOSIE method. Validation of a flux observer for induction motor"  
PESC '92, 29 June - 3 July, 1992, Toledo, Spain.
- [3] B. DAGUES, F. CHOUZAL, X. ROBOAM  
"A powerful system for digital simulation of converter-induction machine assemblies"  
IMACS, Juillet 1993, Montreal, Canada.
- [4] L. GERBAUD, J. BIJEON, G. CHAMPENOIS  
"Modular approach to describe electromechanical systems. Using Macsyma to generate global approach simulation software"  
PESC '92, 29 June - 3 July, 1992, Toledo, Spain.
- [5] O. LOUISNARD, T. MEYNARD, H. PIQUET  
"Simulation program for the design of static power converters : SUCCESS "  
PCIM '92,, 27-30 April 1992 , Nuremberg, Germany.
- [6] N. SADOWSKI, B. CARLY, Y. LEFEVRE  
M. LAJOIE-MAZENC, S. ASTIER  
"Finite element simulation of electrical motors fed by current inverter"  
IEEE-CEFC, August 3-5 1992, Claremont, USA.
- [7] F. CHOUZAL, M. FADEL, B. DAGUES  
"Comparative study of different control laws of a synchronous position drive by means of the simulation program POSTM5"  
SPEEDAM, June 8-10 1994, Taormina, Italy.